

# Identifying Marine Diatoms and Dinoflagellates

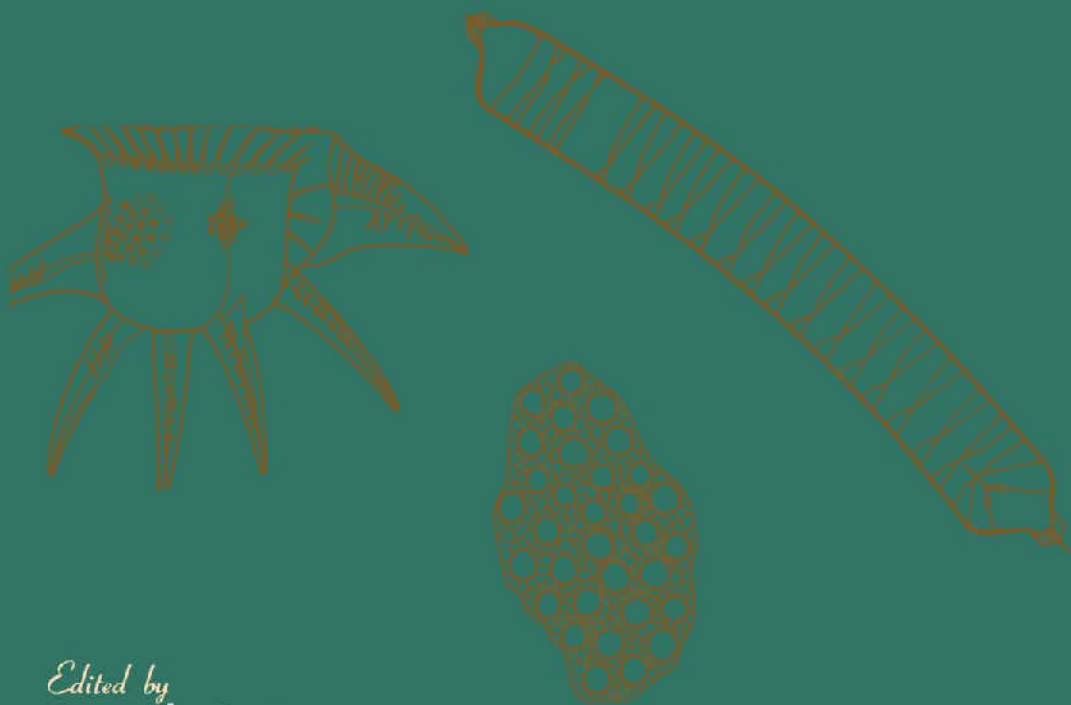
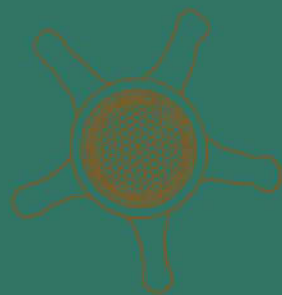

*Edited by*  
**Carmelo R. Tomas**

*Contributors*  
Grethe R. Hasle • Erik E. Syvertsen • Karen A. Steidinger • Karl Tangen

*Identifying  
Marine Diatoms  
and Dinoflagellates*



This Page Intentionally Left Blank

# Identifying Marine Diatoms and Dinoflagellates

---

*Editor*

*Carmelo R. Tomas*

Department of Environmental Protection  
Florida Marine Research Institute  
St. Petersburg, Florida

*Contributors*

*Grethe R. Hasle*

Department of Biology  
University of Oslo  
Oslo, Norway

*Karen A. Steidinger*

Florida Marine Research Institute  
St. Petersburg, Florida

*Erik E. Syvertsen*

Norwegian Pollution Control Board  
University of Oslo  
Oslo, Norway

*Karl Tangen*

OCEANOR  
Trondheim, Norway



**Academic Press, Inc.**  
Harcourt Brace & Company

---

San Diego New York Boston London Sydney Tokyo Toronto

This book is printed on acid-free paper. ☺

Copyright © 1996 by ACADEMIC PRESS, INC.

All Rights Reserved.

No part of this publication may be reproduced or transmitted in any form or by any means, electronic or mechanical, including photocopy, recording, or any information storage and retrieval system, without permission in writing from the publisher.

**Academic Press, Inc.**

A Division of Harcourt Brace & Company  
525 B Street, Suite 1900, San Diego, California 92101-4495

*United Kingdom Edition published by*  
Academic Press Limited  
24-28 Oval Road, London NW1 7DX

Library of Congress Cataloging-in-Publication Data

Identifying marine diatoms and dinoflagellates / [edited] by Carmelo R. Tomas.

p. cm.

Includes bibliographical references and index.

ISBN 0-12-693015-5 (alk. paper)

1. Diatoms--Identification. 2. Dinoflagellates--Identification.

3. Marine phytoplankton--Identification. I. Tomas, Carmelo R.

QK569.D54I34 1995

589.4'3--dc20

95-10871

CIP

PRINTED IN THE UNITED STATES OF AMERICA

95 96 97 98 99 00 BB 9 8 7 6 5 4 3 2 1

# Contents

---

Editor's Foreword	vii
Contributor's Foreword	ix
Contributor's Foreword	xi
Acknowledgments	xiii

## *Chapter 1 Introduction and Historical Background 1*

Grethe R. Hasle and Carmelo R. Tomas

## *Chapter 2 Marine Diatoms 5*

Grethe R. Hasle and Erik E. Syvertsen

Introduction	5
General Characteristics	6
Life Cycles	7
Morphology and Terminology	13
Classification	23
Genera Represented in Marine Plankton	23
Centric Diatoms	23
Pennate Diatoms	26
Identification	27
Content	27
Description of Taxa	28
Centric Diatoms	28
Pennate Diatoms	240
Methodology	331
Collection and Concentration	331

Unialgal Cultures as a Means for Species Identification	333
Preservation and Storage	333
Preparation for Light Microscopy	334
Preparation for Electron Microscopy	335
Microscopy	336
What to Look for—General Hints for Identification and Preparation	337
Taxonomic Appendix	338
New Genus	338
New Names	339
Validation of Names	339
New Nomenclatural Combinations	340
Common Diatom Synonyms	341
Index of Diatom Taxa	351
References	361

## *Chapter 3 Dinoflagellates* 387

Karen A. Steidinger and Karl Tangen

Introduction	387
General Characteristics	387
Dinoflagellates: Eukaryotic Unicells	390
Terminology and Morphology	391
Morphological Types	391
General Cell Terms	391
Microanatomy	401
Characters Used in Identifying Prorocentroid Desmokyont Cells	402
Characters Used in Identifying Dinokyont Cells	403
Identification of Species	416
Techniques for Preparation of Dinoflagellates for Identification	551
Common Dinoflagellate Synonyms	554
Index of Dinoflagellate Taxa	565
References	570

**Index** 585

# *Editor's Foreword*

---

The present volume is the second identification manual created from the literature developed for the Advanced International Phytoplankton Course. This version, enlarged and modified from the earlier literature, deals with the identification of marine diatoms and dinoflagellates. The definitive text for the identification of all marine phytoplankton species will probably never be written and this work clearly claims not to be so; however, species from all oceans and climatic zones are presented here. The absence of any species from this volume does not imply doubt as to its validity but the data and references presented here should allow the researcher to pursue the question of valid species and how they can be verified. While this volume is amply illustrated, by necessity, not all species could be shown. For these as well as for the ones illustrated, when necessary, we encourage the user to return to the original literature to confirm further details.

For the diatoms presented, the major emphasis is on pelagic marine species while there is a presentation of tychopelagic and some benthic species, which in turbulent environments are found within the water column. The dinoflagellates, however, include pelagic and benthic marine species, some of which may be found in brackish environments as well as in the open ocean. Due to their ecological and human health importance, representative toxic and parasitic species are presented here.

As in the companion volume “Marine Phytoplankton: A Guide to Naked Flagellates and Coccolithophorids” (1993), this manual is oriented toward the researcher who uses light microscopy as the major research tool with perhaps limited access to electron microscopy (either scanning or transmission electron microscopy). However, both the diatom and dinoflagellate chapters refer to TEM and SEM views of structures and morphology to emphasize characters which differentiate species. Most of the species illustrated can be identified with light microscopy with occasional use of electron microscopy to confirm identification.

For the user's convenience, there is a list of common synonyms. These synonyms are presented without judgment as to the validity or preference of the names listed. It is left to the user to seek further information in this regard.

The extensive literature citations are not only meant to document the species discussed but to stimulate the user to locate original descriptions in making confirmations of species that are difficult to identify. Finally, it is hoped that this literature will serve as a constant reference to those doing phytoplankton work, novice as well as experienced researcher alike, and make available materials for identifying phytoplankton species which previously were difficult to collect and use routinely.

As Editor of this and the previous manual mentioned, I wish to express my deep gratitude to all the authors. My role as Editor was to act as project facilitator, assisting when I could with text organization, construction, and clarity. Each author had the freedom to design each chapter in their own way respecting the broadest of structures in order to provide the book with an overall format. Clearly the content of each chapter is the creation of the authors and should not be construed in any other way. I feel privileged to have been a part of the team which created this literature and hope that its value will remain for the years to come.

*Carmelo R. Tomas*

# *Contributor's Foreword*

---

The diatoms have been studied for almost 300 years. A multitude of monographs and floras covering smaller and larger areas has been published, and the exact number of thousands of species distributed can hardly be given. Although the marine planktonic diatoms probably constitute a smaller fraction of the total number of species described, we are still dealing with some thousands of species. The elaborately and intricately ornamented siliceous diatom frustule was a challenge to the first transmission electron microscopist in the 1940s, and in the 1960s scanning electron microscopy was introduced in diatom studies providing even better insight into the structure of the diatom cell. This information led to new combinations of species, rejection of species, and description of taxa of all taxonomic categories. The thousands of species, the hundreds of years of studies, the clarification of intricate structures and relationships between taxa obtained by electron microscopy, and the confusion caused by introduction of new names may explain the length of the present chapter.

The history and development of the diatom chapter coincide with the rest of the project, starting with a simple text in 1976, mainly based on the authors' own research. The basis for a manuscript was therefore at hand when the possibility to publish the course notes as a book started to materialize in 1989. The first draft for a complete text was ready for the editor's corrections at the end of 1991 and was returned to the authors at the end of 1992. This version went back to the editor in April–May 1993, to be returned to the authors 1 year later. In April 1994, the editor and the senior author sat together for a short week to finally prepare a manuscript ready to submit to Academic Press.

Diatom research fortunately did not stand still between the start and the final step of the preparation of the diatom chapter. Efforts were made to incorporate, although to a limited extent, literature published in 1992–1994, but with the qualification that time and space did not permit a detailed treatment. During the last years of preparation nomenclatural problems related to the diatoms under study came to our notice. Thanks to Dr. Paul C. Silva as the nomenclature specialist on algae, most of the problems have been solved.



New taxa and nomenclatural combinations having their first appearance in this chapter will hopefully be dealt with in detail in future publications.

The authors are grateful to Tyge Christensen for correction of the latin, to Paul Silva for his patience with the senior author's numerous questions, to Greta Fryxell for comments on *Pseudo-nitzschia* and *Thalassiosira*, to Frithjof Sterrenburg for comments on *Pleurosigma*, and to Bo Sundstrom for letting us copy his *Rhizosolenia* drawings. Carmelo Tomas is especially thanked for his editorial assistance; his initiative and sustained effort fulfilled the senior author's long-dreamt dream to get literature prepared for the International Phytoplankton Courses formally available to a greater audience. E. Paasche and Carina Lange carefully read and commented on parts of the manuscript; Berit Rytter Hasle assisted with the preparation of the line drawings, and the electron micrographs were made at the Electron Microscopical Unit for Biological Sciences at the University of Oslo.

The project was supported by grants from the Norwegian Fisheries Research Council (1202-203.075 to E.E.S.), and from the Norwegian Research Council for Science and the Humanities (457.90/027 to E.E.S., 457.91/001 and 456.92/006 to G.R.H.). The senior author expresses gratitude to the Department of Biology, University of Oslo, for financial support and also for continued working facilities after retirement.

Grethe R. Hasle

# *Contributor's Foreword*

---

Advances in microscopy have furthered our ability to differentiate genera and species based on morphology and cytology. Concurrent with these advances in equipment and technique were individual studies that clarified useful characters; for example, E. Balech's recognition and characterization of sulcal and cingular plates; D. Wall's, B. Dale's, and L. Pfister's characterization of life-cycle stages; H. Takayama's characterization of apical grooves or what B. Biecheler described as acrobases; J. Dodge's characterization of apical pore complexes; and F. J. R. Taylor's synthesis and interpretations on dinoflagellate taxonomy, biology, and evolution. These scientists are counted among my heroes. In the future, there will be more heroes who will have worked on optical pattern recognition, biochemical systematics and molecular probes, and other new avenues to identify species and relatedness among species.

My deepest respect and appreciation go to my Norwegian colleagues to whom I am indebted for inviting me to be an instructor and for sharing their knowledge, wisdom, kindness, and sense of humor with me. To Dr. Karl Tangen of OCEANOR, my collaborator, I offer special thanks. To my friend and mentor, Dr. Enrique Balech of Argentina, I offer my sincerest appreciation for teaching me to see beyond what is obvious and to interpret plate patterns and species differences. To Dr. Jan Landsberg (Florida Department of Environmental Protection, Florida Marine Research Institute) and Julie Garrett (Louisiana State University) I offer my gratitude for encouraging and helping me to complete this project. To the editor of this series, Dr. Carmelo Tomas, I express my gratitude for his patience, resolve, and continued friendship. I also thank and acknowledge Dr. Earnest Truby (Florida Department of Environmental Protection, Florida Marine Research Institute) and Dr. Elenor Cox and Clarence Reed (Texas A&M University) for the loan of their exceptional, unpublished scanning electron micrographs of armored species that were used to draw some of the composite illustrations in the plates. Julie Garrett provided most of the scanning electron micrographs of apical pore complexes. Consuelo Carbonell-Moore (Oregon State University) shared her knowledge of the Podolampaceae with me and is credited for photographs in Plate 7. Llyn French (Florida Department of Environmental Protection, Florida Marine Research Institute)

assisted in preparation of the plates and provided artistic advice. Diane Pebbles, a biological illustrator and artist, provided 80% of the species illustrations, many of them original drawings based on scanning electron micrograph images. Her work increases the value of this chapter. Dr. Haruyoshi Takayama (Hiroshima Fisheries Experimental Station) provided all the photographs of apical grooves in Plates 1 and 2.

*Karen A. Steidinger*

# Acknowledgments

---

In addition to the acknowledgments given in the Forewords, the following agencies and institutions have substantially contributed to this work. Without their financial and logistical support, this work could not have been completed. The editor and authors are indebted to the support of the following:

The Norwegian Research Council for Science and the Humanities  
The Norwegian Fisheries Council  
Stazione Zoologica "Anton Dohrn" di Napoli  
UNESCO  
Department of Biology, University of Oslo  
Florida Department of Environmental Protection, Florida Marine  
Research Institute

For supporting the International Phytoplankton Course from which this literature was developed, contributions were also made by:

NORAD  
Italian National Research Council  
Italian Ministry of Foreign Affairs  
U.S. Office of Naval Research  
Carl Zeiss Company, Oberkochen

Numerous individuals helped during various phases of the preparation of this text and illustrations. Special thanks are given to Cele Tomas for her invaluable help, countless hours of labor, continued support, and infinite patience. She not only gave editorial assistance but remained a staunch supporter over the long duration of the project. Ms. Llyn French freely gave of her expertise in illustration, graphics, and the many aspects of page design. Colleagues at Stazione Zoologica have been especially supportive. These include Donato Marino, Marina Montresor, and Adriana Zingone. Dr. Dirk Troost from UNESCO and Professor Gaetano Salvatore, President of Stazione Zoologica, provided financial support from their respective institutions.

This Page Intentionally Left Blank

# Introduction and Historical Background

*Grethe R. Hasle and Carmelo R. Tomas*

The content of this book as well as the earlier companion volume “Marine Phytoplankton: A Guide to Naked Flagellates and Coccolithophorids” had its origins as teaching and “handout” literature developed for the Advanced International Phytoplankton Course. Since the original course in 1976, the literature has been updated, improved, and tested on the talented selected participants for each course. With each course offering, requests were made to have the literature presented in a more permanent format as a published book(s). The urgency for the need of such literature was seen as photocopies of the handouts began to appear in various laboratories around the world. Prior to the last course in 1990, an attempt to finalize this goal was realized with the agreement to write one book containing this literature. Here we will briefly present the steps of the procedure leading to the publication of this volume.

The idea of an International Course in Phytoplankton had its origins with Professor Trygve Braarud at the University of Oslo, Norway. Within his archived files are notes where Professor Braarud considered a course to teach young students of phytoplankton. The faculty would consist of Professor F.

Hustedt (Diatoms), Professor J. Schiller (Dinoflagellates), and Professor E. Kamptner (Coccolithophorids). These names, gurus of the phytoplankton studies of the first half of this century, would have truly made an all-star teaching team. This dream was realized but not with the cast originally designed, as by the time the course was ready to be taught, most of these mentors were deceased.

In January 1969, a working Group of Phytoplankton Methods (WG 33) was established during the executive meeting of the Scientific Committee in Oceanic Research (SCOR). During this meeting, Professor Braarud pointed out the urgent need for considering phytoplankton methods other than those involving pigment and other chemical analyses. The IOC Working Group on Training and Education also commented on the need for modern textbooks and manuals (Unesco technical papers in marine science no. 18, Paris, 1974).

In Item 4 of the Terms of Reference to WG 33, the Working Group was asked to prepare a report including reference to literature in taxonomy of the main groups and on methods for using quantitative phytoplankton data in ecological studies. To fulfill this request, the Working Group suggested a list of the contents of such a manual and a tentative plan for a "Phytoplankton Course for Experienced Participants." The University of Oslo was chosen as the place for the course and the Marine Botany Section as responsible for the teaching program.

The preparation of a Phytoplankton Manual of Methodology started with a meeting at the University of Oslo under the auspices of SCOR in 1974. The "phytoplankton manual" was published in 1978 by Unesco as "Monographs on Oceanographic Methodology 6" with A. Sournia as the editor. No further steps were taken to prepare a corresponding manual on phytoplankton taxonomy although a need had been expressed by some members of WG 33.

The first "Phytoplankton Course for Experienced Participants" was held at the University of Oslo during 4 weeks in August–September 1976 with 17 participants from 13 different countries. After the first offering, the length of the course was cut to 3 weeks, and the next two courses, in the autumns of 1980 and 1983, were held at the Biological station in Drøbak, belonging to the University of Oslo. Stazione Zoologica "Anton Dohrn," Naples, Italy, hosted and organized the courses now called "Advanced Phytoplankton Courses, Taxonomy and Systematics" in 1985 and 1990. Another session of this course is presently being planned for Fall 1995 to be held again at the Naples facility.

From the very beginning interest in the courses was considerable and increased with each offering. In 1990, more than 100 applications were received for the 15–17 places available. The apparent need for a course dealing with identification of phytoplankton species became more evident with the increased activity in mariculture, the recurrence of harmful phytoplankton blooms, the

documented toxicity of certain species, the apparent increased pollution of the sea, and global atmospheric changes.

A total number of 77 participants, representing 35 countries, participated in the five courses to date. The instructors in 1976 were the late Karen Ringdal Gaarder (coccolithophorids, dinoflagellates), Grethe Rytter Hasle (diatoms, dinoflagellates), E. Paasche (algal physiology, cultures), Karl Tangen (dinoflagellates), Jahn Thronsen (naked flagellates), and Berit Riddervold. All the instructors with the exception of Berit Riddervold Heimdal (coccolithophorids), from the University of Bergen, were from the University of Oslo. In 1983, Karen A. Steidinger, Florida Marine Research Institute, and Karl Tangen, now Oceanor, Trondheim, Norway, taught dinoflagellates and Barrie Dale, University of Oslo, lectured on dinoflagellates cysts. Erik E. Syvertsen, University of Oslo, assisted G. R. Hasle with the diatoms. From 1985 the staff of Stazione Zoologica also participated in the teaching.

The courses were sponsored by SCOR and IABO, and financially by UNESCO, NORAD (Norwegian Agency for International Development), the Norwegian Ministry of Foreign Affairs, the Italian Ministry of Foreign Affairs, the Italian National Research Council, the U.S. Office of Naval Research, Stazione Zoologica "A. Dohrn" di Napoli, and the University of Oslo.

Despite the unique collection of reprints and identification literature available during the course at the University of Oslo, and later at the Stazione Zoologica, class notes and handouts had to be prepared. They started out with a few pages on each group and increased gradually with additional information from the literature and the respective instructor's own research. In 1983, mainly by Karen Steidinger's initiative, contacts were made with publishing companies to formalize an officially published text. These attempts failed, but in 1989 Carmelo R. Tomas (participant of the 1983 course) started successful negotiations with publishing companies for a text to be used in the 1990 course. Again this deadline was not accomplished but a firm commitment from the authors, editor, and publishing company was definitely made. Consequently, the course notes changed in format and increased in content to form the basis of a manuscript for publication. It became evident that the flagellate and coccolithophorid texts would be completed ahead of those on the diatoms and dinoflagellates. This plus the fact that the newly expanded version of the diatom and dinoflagellate sections exceeded the original project would make a book containing all parts too large for a handy volume. After renegotiation between Academic Press and Carmelo Tomas as the editor, it was decided that a volume on flagellates and coccolithophorids would be published first to be followed by the present one on diatoms and dinoflagellates.

Running expenses inside Norway, related to the manual project, were covered by grants from the Department of Biology, University of Oslo; the Norwegian Research Council for Science and the Humanities (NAVF 457.90/041); and from the Norwegian Fisheries Research Council (project 66170).



Planning funds for the literature were also awarded to the editor from UNESCO while funds for illustrations, technical assistance, postage, and communications were given by Stazione Zoologica of Naples. Since no member of this team was funded to work full-time on this project, each person gave of their personal time and effort to accomplish the goal of completing these manuals. The respective institutions gave support, as was possible, affording each author and editor the opportunity to work on this project. The support notwithstanding, each member of this team worked on this literature while assuming full duties of their permanent work assignments.

# Marine Diatoms

*Grethe R. Hasle and Erik E. Syvertsen*

### INTRODUCTION

---

The study of diatoms began in the 18th century. The name of the class Bacillariophyceae was derived from the genus *Bacillaria* Gmelin 1791, whereas “Diatom” refers to the genus *Diatoma* De Candolle 1805. Despite more than a century of devoted morphological and taxonomic investigations, electron microscopy, introduced to diatom research in the middle of the 20th century, revealed additional information. A reevaluation of the established classification systems and the current ideas and information on biogeography was required, and a new era of diatom investigations began.

Simonsen (1979) introduced a diatom system based on results from light and electron microscopy and constructed a key to the diatom families. Other ideas on classification, evolution, and critical evaluations at the higher taxonomic levels followed, based on the increasing amount of information (Cox, 1979; Round & Crawford, 1981, 1984; Fryxell, 1983; Glezer, 1983; Nikolaev, 1984; Williams & Round, 1986, 1987), resulting in two partially diverging diatom systems (Glezer et al., 1988; Round et al., 1990).

Publications summarizing the new information on diatom morphology as well as a revision of the classical identification literature were needed. To meet this requirement several diatom atlases, floras and handbooks were published during the past decade or so, most of them concentrating on a particular geographical region. Ricard (1987) constructed keys to families and genera with genus as the lowest rank, the genera being illustrated with light and electron micrographs of one or a few species of each. The diatom handbooks by Priddle & Fryxell (1985) and Medlin & Priddle (1990) both deal with polar species. The focus of the former is on some planktonic diatoms commonly recorded in the Southern Ocean. The latter, a more comprehensive handbook, includes the two polar regions and has an ecological as well as a taxonomic part with keys to species. The diatom atlas from India and the Indian Ocean region (Desikachary, 1986–1989) contains only light micrographs of the diatoms recorded in the area with no additional text, and the phytoplankton atlas by Delgado & Fortuño (1991) has text as well as line drawings and scanning electron micrographs of diatoms from the Mediterranean.

The publications by Rivera (1981), Makarova (1988) and Rines & Hargraves (1988) have the character of monographs of the marine planktonic genera *Thalassiosira* (the former two publications) and *Chaetoceros* (the latter publication), although based on material from specific geographical areas. The investigation of *Rhizosolenia*, a third important marine planktonic genus, by Sundström (1986) is based on material from almost all oceans, and the Unesco Manual on Harmful Microalgae has a chapter on this category of diatoms (Hasle & Fryxell, in press).

The monumental diatom volume by Round et al. (1990) differs from all the publications mentioned previously in content as well as size; it consists of sections on the biology of the diatoms, a summary of the introduced classification, and a generic atlas. Linnaeus, a catalogue and expert system for the identification of protistan species (Estep et al., 1992), includes diatoms, and the catalogue by Gaul et al. (1993) lists papers containing electron micrographs of diatoms and is thus useful to those studying the fine structure of the diatom frustule.

Despite these recent publications, teaching experience tells us that there is still a need to fill in respect to the global aspect of the identification of marine planktonic diatoms at the specific level. We hope to fill a part of this need with this chapter.

## GENERAL CHARACTERISTICS

**Systematics:** Class Bacillariophyceae in the division Chromophyta.

**Closest relatives:** Chrysophyceae and Xanthophyceae. (See Round et al., 1990, p. 122.)

**Number of species:** 10,000–12,000, approx 50,000 (Round & Crawford, 1984, p. 169), or in excess of 100,000 (Round & Crawford, 1989, p. 574); or in marine plankton approx 1400–1800 (Sournia et al., 1991, p. 1085).

**Size:** ca. 2  $\mu\text{m}$ –ca. 2 mm.

**Level of organization:** Unicellular, often in colonies.

**Cell covering:** Siliceous wall and organic layer.

**Flagella:** Male gametes with one flagellum with stiff hairs.

**Chloroplasts:** Lamellae with three thylakoids, girdle lamella, and four membranes around the chloroplast.

**Pigments:** Chlorophylls *a* and *c*, betacarotene, fucoxanthin, diatoxanthin, and diadinoxanthin.

**Mitochondria:** Tubular type.

**Storage products:** Chrysolaminarin and oil.

**Motility:** Present in pennate diatoms with a raphe.

**Biotores:** Marine and freshwater, plankton, benthos, epiphytic, epizotic (e.g., on whales and crustaceans), endozoic (e.g., in foraminifera), endophytic (e.g., in seaweed), on and in sea ice, and “air diatoms.”

**Geological age:** Centrics: Jurassic (a few species) and Early Cretaceous (Gersonde & Harwood, 1990). Araphid pennates: Late Cretaceous (Medlin et al., 1993, with references). Raphid pennates: Middle Eocene (Medlin et al., 1993, with references).

## LIFE CYCLES

### Reproduction (Figs. 1a and 1b)

Diatoms reproduce vegetatively by binary fission, and two new individuals are formed within the parent cell frustule. Each daughter cell receives one parent cell theca as epitheca, and the cell division is terminated by the formation of a new hypotheca for each of the daughter cells. This type of division, with formation of new siliceous components inside the parent cell, leads to size reduction of the offspring. The possible size range of the diatom cells seems to be species dependent, and the specific variation may be as large as 8 to 10 times the length of the apical axis or the diameter.

The considerable size variation is often accompanied by a pronounced size dependent change in cell proportions, normally in the form of an increase in the ratio between the length of the perivalvar axis and the apical axis or diameter. In addition, size variation often causes changes in valve ornamentation, like a reduction in the number of central clustered processes in *Thalassiosira* spp. (E. Syvertsen, personal observations), a loss of special structures like the pili of certain species of the Cymatosiraceae (Hasle et al., 1983), and an alteration of the valve outline of morphologically bipolar species from elongate toward almost circular, e.g., *Fragilaria* spp. (Hustedt, 1959) and Cymatosiraceae.

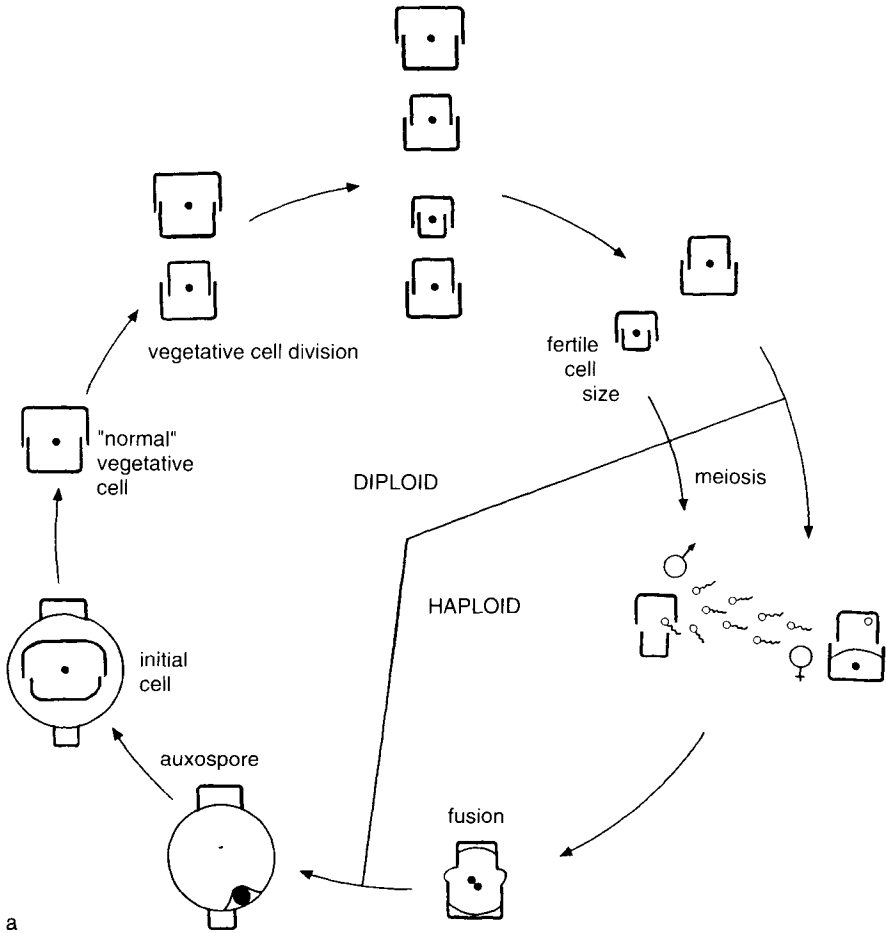

**FIGURE 1** (a) Sexual reproduction of a centric diatom (oogamy) and (b) of a pennate diatom (morphological isogamy, physiological anisogamy). ●, Zygote; ●, nucleus; ○, pycnotic nucleus.

The decrease in the average cell size of a diatom population during vegetative growth implies a need for a means of restoring the cell size. This is made possible by auxospore formation, in which a cell sheds its siliceous theca, thereafter forming a large sphere surrounded by an organic membrane. Within this sphere, a new diatom frustule of maximal size is formed, and the cycle starts anew. The first cell formed inside the auxospore, the initial cell, may have a morphology deviating in girdle structure, valve outline, and process pattern from that of a "normal" vegetative cell (*vide*, *Thalassiosira decipiens*, Hasle, 1979, Fig. 41; *Cymatosira lorenziana*, Hasle et al., 1983, Fig. 19).

Auxospore formation is size dependent and normally takes place when the cell has reached about one-third of its maximal size (Drebes, 1977). Below

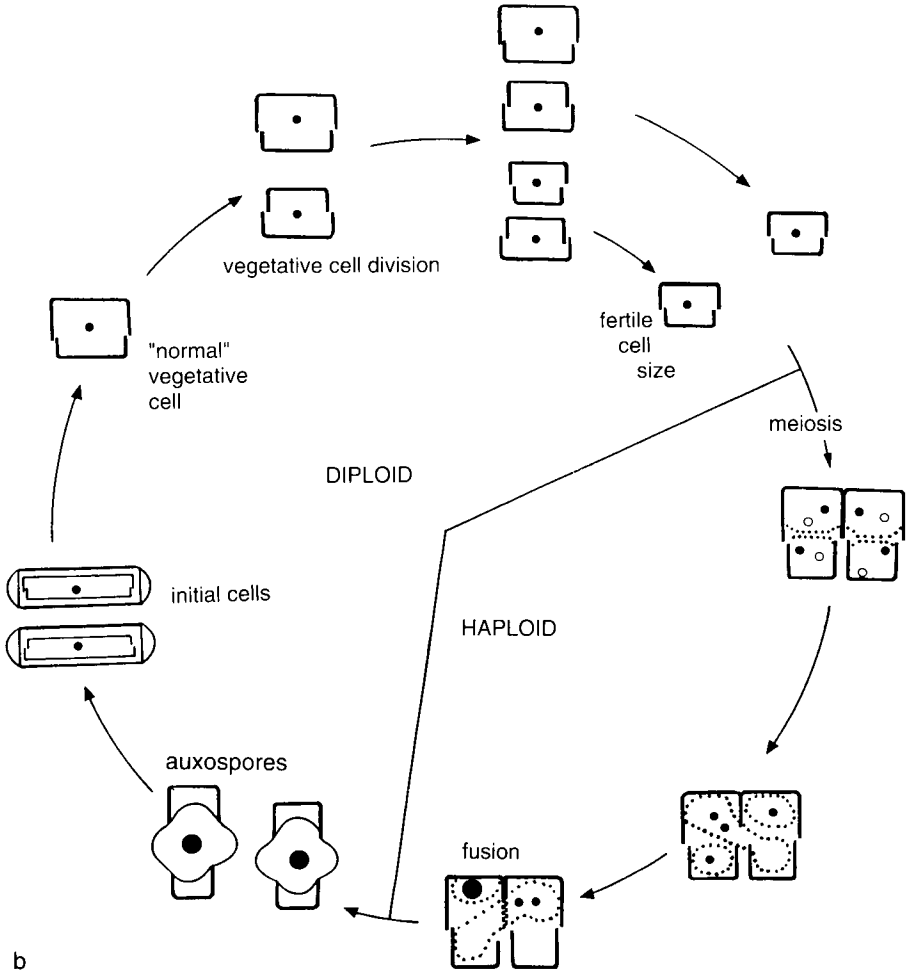

FIGURE 1 (Continued).

this limit the diatoms seem unable to rejuvenate themselves, and they continue to divide until they reach a stage at which cell division is no longer possible. There are reports in the literature of taxa which do divide without a simultaneous size reduction (Drebes, 1977), and some species seem to be able to multiply at their lower size limit without further size reduction for an extended length of time (E. Syvertsen, personal observations). For most species, however, auxospore formation is a necessary and normal occurrence in their life cycle. It may take place as a vegetative event or as the result of sexual reproduction.

All diatoms are diplonts with a meiosis at the end of the gametogenesis. The zygote develops into an auxospore. In the centric diatoms, sexual reproduc-

tion is by oogamy with flagellated male gametes, while most pennate diatoms are morphologically isogamous lacking a flagellated stage. A few araphid species have been shown to be anisogamous (Drebes, 1977) and are considered to represent a transitional stage between centric and pennate diatoms. Since the diatoms are thought to have evolved from centrics toward pennates (see also Geological age), this implies a development from oogamy toward isogamy, contrary to what is considered the normal evolution in other groups.

One peculiar consequence of the diatom mode of vegetative multiplication is the possible "eternal life" of larger valves, resulting from the fact that one of the daughter cells inherits one of the parent cell thecae. Nothing seems to be known about how many times a theca can be "reused" in this way. Theoretically, it could go on indefinitely if the cells are not destroyed by external factors. But even if the thecae are reused only a few times, the valve morphology of certain cells may reflect earlier events in the life of the population. As discussed below, a vegetative cell may have a resting spore epitheca documenting previous resting spore formation. In the same way, various valve morphotypes may be found in a population of a species capable of developing morphologically distinct forms in response to environmental influences.

### Heteromorphy

Many diatoms are heterovalvate, i.e., the two valves of a frustule are dissimilar. This is most prominent within the family Achnantheaceae, where the cells have one valve with a raphe and the other without a raphe, and in the Cymatosiraceae, where one valve has a tubular process and the other does not.

Chain-forming species with cells linked together by siliceous structures may, in addition, have separation valves. These valves are morphologically different from the valves within the chain. Thus, *Cymatosira lorenziana* has four morphologically distinct types of valves: a separation valve with a tubular process, a separation valve without a tubular process, and intercalary valves with and without a process, respectively. In the genera *Bacteriastrum*, *Chaetoceros*, *Paralia*, and *Skeletonema*, the intercalary valves of the chains are all alike and different from the separation valves (Fryxell, 1976; Crawford, 1979).

Another type of heteromorphy may be found with species in which the morphology varies in response to changes in the environment. These morphotypes are generally considered to be forms of the species. During and after environmental changes specimens may be found which have two different valves reflecting different environmental conditions. This type of morphological adaptation has been found in *Thalassiosira rotula*. In this species, the valve morphology changes in response to variations in temperature and the girdle morphology changes in response to available nutrients (Syvertsen, 1977).

### Resting Spore Formation (Fig. 2)

The diatom resting spores are first and foremost recognized by their heavily silicified frustules. The resting spore morphology of some species is similar to that of the corresponding vegetative cells, whereas in other species, the resting spores and the vegetative cells differ drastically (Syvertsen, 1979, 1985).

Diatom resting spores are normally formed as a response to unfavorable environmental conditions, and germination occurs when the conditions improve (see Hargraves & French, 1983, for a review). Resting spore formation is common in centric, but rare in pennate marine planktonic diatoms. Whereas resting spores of several centric marine planktonic diatoms germinate in culture within a few days, the freshwater benthic pennate species, *Eumotia soleirolii* (Kützing) Rabenhorst, requires a dormancy of several weeks (von Stosch & Fecher, 1979) before germination. *Achnanthes taeniata* and *Fragilariopsis oceanica* are pennate marine planktonic diatoms known to form resting spores; whether a dormancy period is present in these species is unknown.

Three types of resting spores can be distinguished: exogenous resting spore—the mature resting spore is not physically in contact with a parent cell theca; semiendogenous resting spore—the spore hypovalve is enclosed within one of the parent cell thecae; and endogenous resting spore—the whole spore is enclosed within the parent cell frustule. Normally two or more exogenous resting spores [e.g., a chain of 13 resting spores of *Detonula confervacae* (Syvertsen, 1979)], two semiendogenous resting spores [e.g., *Thalassiosira australis* (Syvertsen, 1985)], and one endogenous resting spore [e.g., *Chaetoceros* spp. (Hargraves, 1979)] are formed. All three types were found in clonal cultures of *Thalassiosira nordenskioldii* and *T. antarctica* with the semiendogenous type as the most common (Syvertsen, 1979).

Resting spore morphology is a more constant, specific feature than the type and mode of formation and, thus, is of greater taxonomic value. Until disproven by Syvertsen (1979) for centric diatoms and by von Stosch & Fecher (1979) for pennate diatoms, it was generally believed that resting spores had no girdle and thus differed from vegetative cells. Among the centric diatoms, the general trend seems to be that resting spores of species, possibly early in the phylogenetic diatom system (e.g., *Thalassiosira* and *Stellarima*), have a girdle and are often morphologically similar to the vegetative cells. Resting spores of species in the possibly more advanced part of the system (e.g., *Bacteriastrium* and *Chaetoceros*) are usually very different from the vegetative frustules and often lack a girdle. This seems to coincide with a suggested development from exogenous or semiendogenous toward endogenous resting spores (Syvertsen, 1979). On the other hand, phylogenetically advanced pennate diatoms, e.g., *Achnanthes taeniata* and *Fragilariopsis oceanica*, form resting spores with a girdle. A special case occurs when resting spores are formed within auxospores. This takes place, for instance, in *Chaetoceros eibenii* (von Stosch et



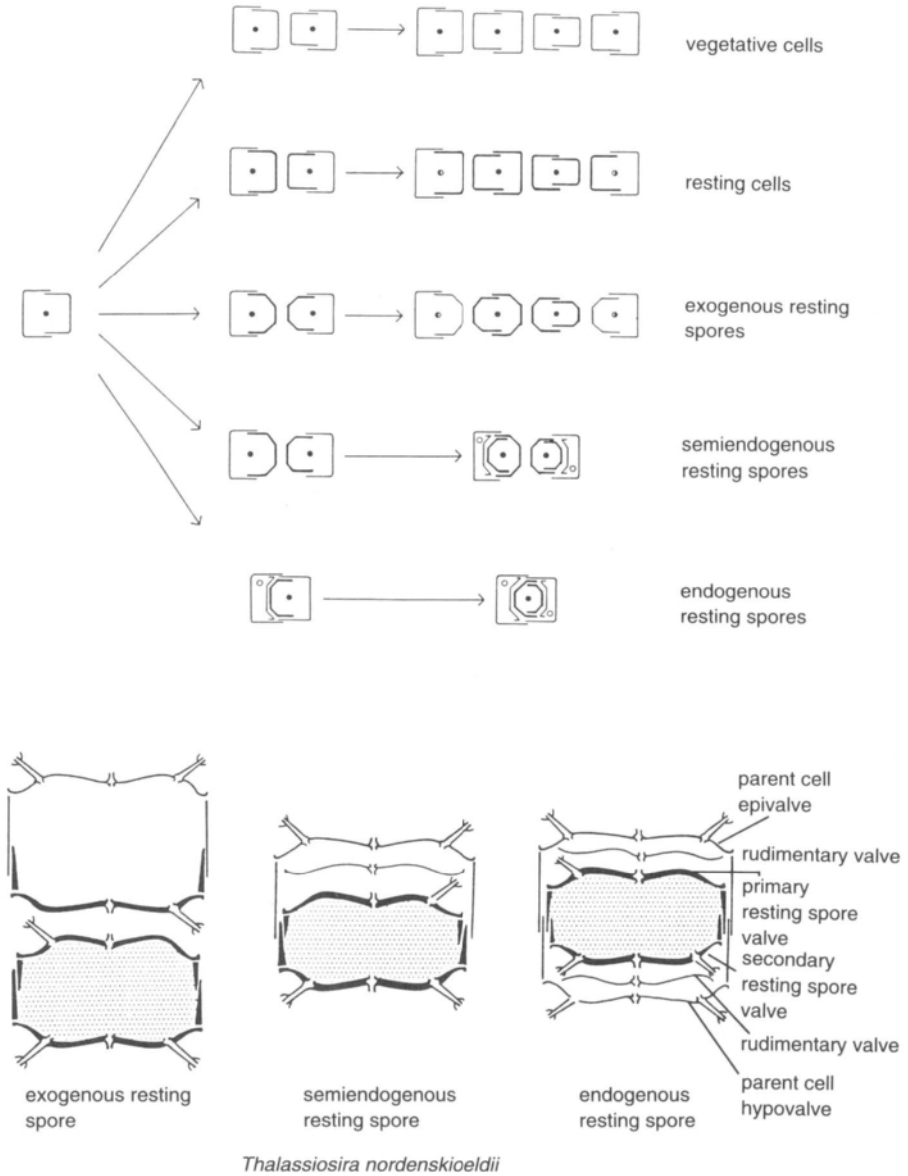

FIGURE 2 Formation of vegetative cells, resting cells, and resting spores from a vegetative parent cell. *Thalassiosira nordenskiöldii* is an example of a species forming all three types of resting spores.

al., 1973) and in *Leptocylindrus danicus* and *L. minimus* (Hargraves, 1990). Unlike other diatoms known so far, the resting spores are an obligate part of the life cycle of *L. danicus* (French & Hargraves, 1985).

Resting spore formation includes two cytokinetic mitoses (von Stosch et al., 1973), where one or both may be unequal. Depending on the degree of dissimilarity, the rudimentary cells may or may not be visible (Syvertsen, 1979). In terms of morphology, the rudimentary valves are often intermediate between vegetative and resting spore valves, but may be sufficiently different to risk being described as separate species unless their origin is known [*vide Thalassiosira australis* (Syvertsen, 1985)].

The two valves of a resting spore may be similar or distinctly different. Often the first valve formed (primary resting spore valve) is more similar to the valves of the vegetative cells than is the second valve (secondary resting spore valve). Thus, during resting spore formation at least four morphologically different valve types may be found which can easily be and probably often have been identified as belonging to different species. These valve types are (1) normal vegetative valves, (2) rudimentary valves, (3) primary resting spore valves, and (4) secondary resting spore valves. In addition, intermediate valve types between those mentioned and representing various degrees of development are often seen (E. Syvertsen, personal observations). This diversity of valve types belonging to one and the same species calls for caution in identification work using cleaned diatom material.

Resting spores germinate in two ways, according to whether or not they have a girdle. Spores with a girdle germinate to form two new vegetative cells where the resting spore thecae serve as epithecae [e.g., *Thalassiosira* (E. Syvertsen, personal observations)], while spores lacking a girdle shed the spore valves in the process of vegetative cell formation, as with *Bacteriastrium* and *Chaetoceros* (von Stosch et al., 1973). In the first case, chains formed after resting spore germination have the resting spore valves as epivalves on the end cells, and these cells are thus heterovalvate.

## MORPHOLOGY AND TERMINOLOGY

With an increasing amount of information on details of the siliceous diatom cell wall, especially that obtained with electron microscopy, a need for a generally accepted terminology became evident in the early 1970s. The first attempt along this line was published in 1975 as "Proposals for a Standardization of Diatom Terminology" (Anonymous, 1975; von Stosch, 1975) followed by "An Amended Terminology for the Siliceous Components of the Diatom Cell Wall" (Ross et al., 1979). These publications contain glossaries in Latin, English, German, and French. A Russian translation of Anonymous (1975) was published by Makarova (1977).

When the fine structure of pennate diatoms became more extensively studied, new terms were introduced (Mann, 1978, 1981; Cox & Ross, 1981; Williams, 1985, 1986). Terms specific to certain centric diatom families or genera, partly applicable to light microscopy, were also suggested (Hasle et al., 1983; Sundström, 1986; Rines & Hargraves, 1988).

The text of this chapter follows the current terminology, including, in part, that of Barber & Haworth (1981). The gross morphology of the diatom frustule and structures more generally distributed within the class are defined in this chapter. Terms specific to particular taxa are defined in the introductory text to these taxa. The definitions of the terms may include elements not readily revealed by light microscopy. This does not exclude the possibility to recognize the presence of a particular structure. For example, the tubular parts of strutted processes may be visible in the light microscope, while the satellite pores are usually not observable.

#### **Gross Morphology (Figs. 3 and 4)**

**Apical axis**—long axis of a bilateral diatom—axis between the poles of a frustule.

**Pervalvar axis**—axis through the center point of the two valves.

**Transapical axis**—third axis of a bilateral diatom.

**Valvar plane**—parallel to the valves—plane of division.

**Apical plane**—perpendicular to the transapical axis.

**Transapical plane**—perpendicular to the apical axis. (If more specified terms are required, see Round et al., 1990, p. 23, Fig. 18.)

**Valve view**—frustule seen from top or bottom.

**Broad girdle view**—frustule seen from broad side.

**Narrow girdle view**—frustule seen from narrow side.

**Frustule**—the whole diatom box.

**Epitheca**—upper overlapping part of frustule.

**Hypotheca**—lower part of frustule.

**Valve**—epi-, hypo-.

**Valve mantle**—marginal part of valve, set off from valve face at an angle.

**Valve face**—part of valve surrounded by mantle.

**Girdle**—part of frustule between epi- and hypovalves consisting of epi- and hypocingula.

**Cingulum**—portion of the girdle associated with a single valve.

**Band or segment**—a single element of the girdle.

**Intercalary band(s)**—**copula(e)**—**element(s)** nearest to the valves, different in structure from elements farther away from the valves.

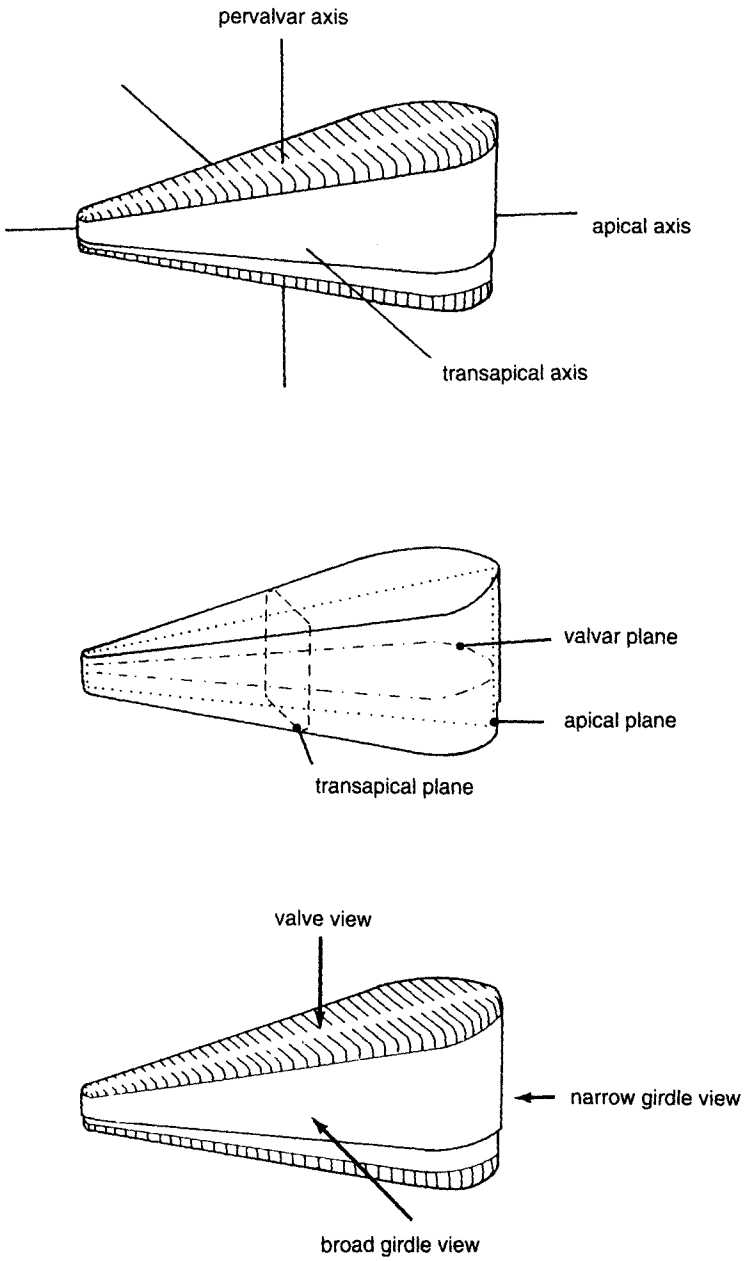

FIGURE 3 Axes and planes of a diatom frustule.

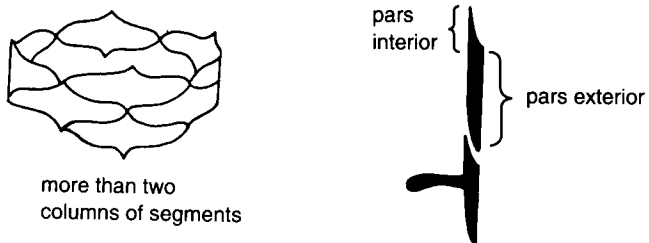
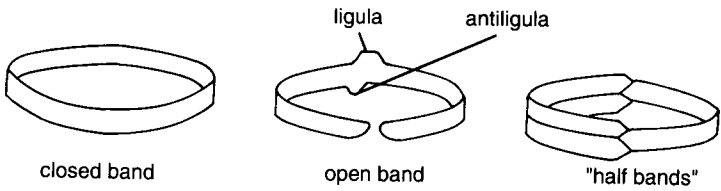
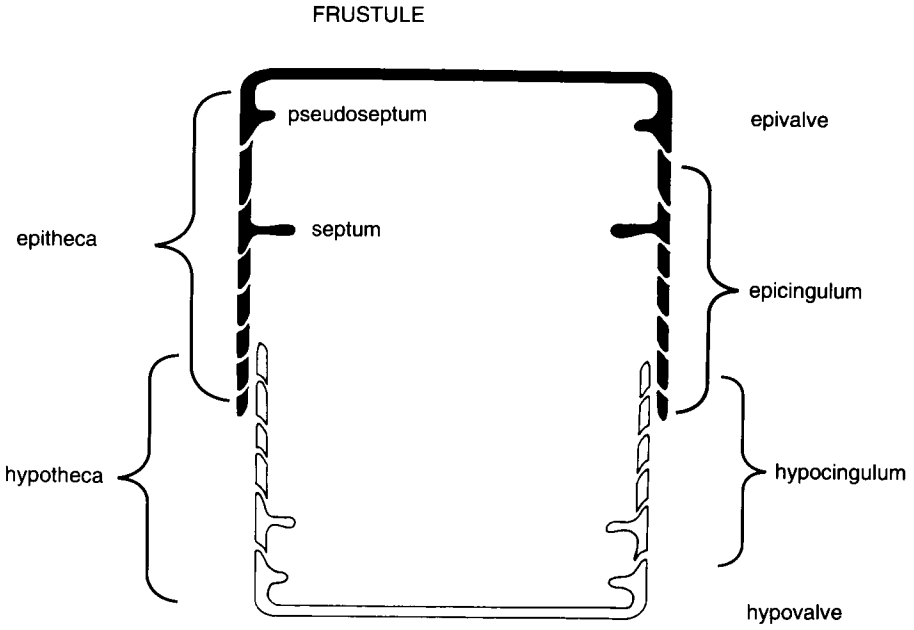

FIGURE 4 Gross morphology of the frustule, types of girdle bands and segments, and overlapping of bands.

**Valvocopula**—band adjacent to a valve.

**Connecting band(s)**—**pleura(e)**—element(s) in the middle of the girdle when intercalary bands are present or any element when no intercalary bands are present.

**Septum**—a sheet or ridge in the valvar plane projecting from a girdle band into the interior of the frustule, often with several openings.

**Hyaline band**—element of girdle with no perforations (see Hemidiscaceae).

#### Fine Structure of the Siliceous Cell Wall (Figs. 5 and 7)

**Basal siliceous layer**—the layer that forms the basic structure of the various components of the frustule.

**Annulus** (von Stosch, 1977)—a ring of costal thickness, often surrounding one or more processes and with a structure different from that of the rest of the valve (see *Porosira* and *Actinocyclus*).

**Areola**—regularly repeated perforation through the valve wall, often marked by more or less elaborate multiangular walls or ribs (definition slightly deviating from Ross et al., 1979, p. 527).

**Velum**—a thin perforated layer of silica across an areola.

**Cribrum**—a velum perforated by regularly arranged pores.

**Foramen**—the passage through the constriction at the surface opposite the velum.

**Poroid areola or poroid**—an areola not markedly constricted at one surface of the valve.

**Loculate areola or loculus**—an areola markedly constricted at one surface of the valve and occluded by a velum at the other.

**Alveolus**—an elongated chamber running from the central part of the valve to margin, open to the inside and covered by a perforate layer on the outside.

**Stria**—one or more rows of areolae or pores, or an alveolus. Uniseriate, one row; biseriate, two rows; multiseriate, many rows.

**Interstria**—the nonperforate siliceous strip between two striae.

#### Processes (Figs. 6–8)

**Process**—projection with homogeneously silicified walls.

**Labiata process**—**rimoportula**—a tube or an opening through the valve wall with an internal flattened tube or longitudinal slit surrounded by two lips.

**Spine**—a closed or solid structure projecting out from the surface of the frustule.

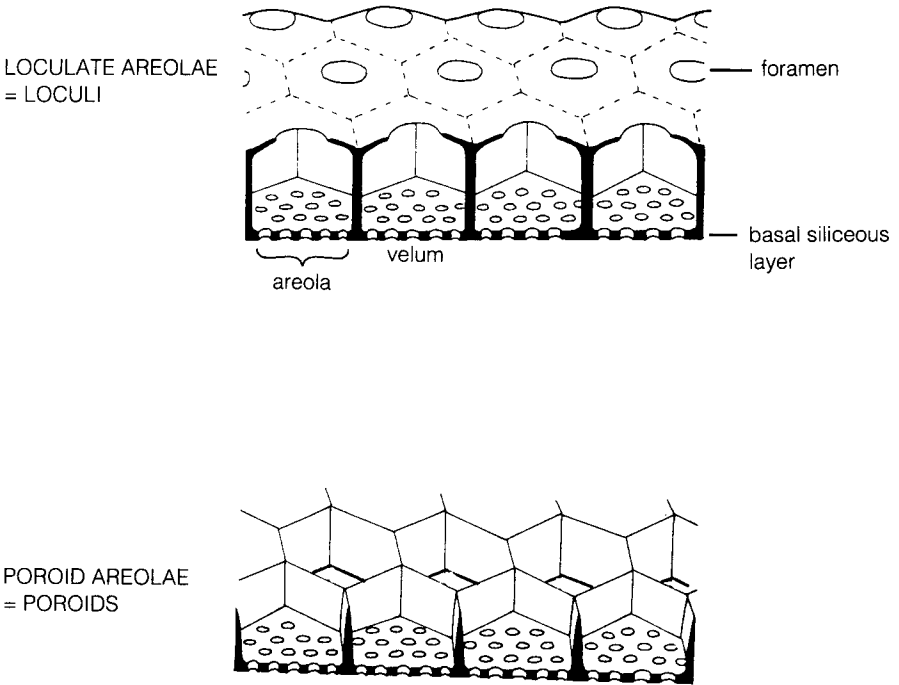

POROID AREOLAE  
= POROIDS

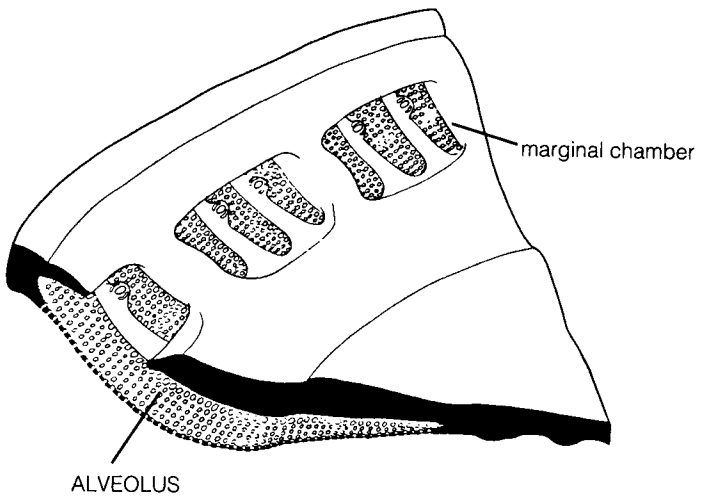
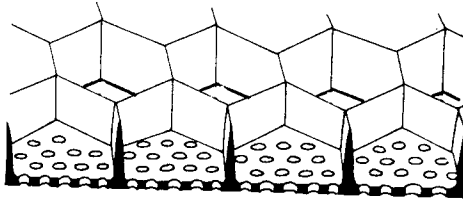

FIGURE 5 Fine structure of the siliceous cell wall.

**Valvocopula**—band adjacent to a valve.

**Connecting band(s)**—**pleura(e)**—element(s) in the middle of the girdle when intercalary bands are present or any element when no intercalary bands are present.

**Septum**—a sheet or ridge in the valvar plane projecting from a girdle band into the interior of the frustule, often with several openings.

**Hyaline band**—element of girdle with no perforations (see Hemidiscaceae).

#### Fine Structure of the Siliceous Cell Wall (Figs. 5 and 7)

**Basal siliceous layer**—the layer that forms the basic structure of the various components of the frustule.

**Annulus** (von Stosch, 1977)—a ring of costal thickness, often surrounding one or more processes and with a structure different from that of the rest of the valve (see *Porosira* and *Actinocyclus*).

**Areola**—regularly repeated perforation through the valve wall, often marked by more or less elaborate multiangular walls or ribs (definition slightly deviating from Ross et al., 1979, p. 527).

**Velum**—a thin perforated layer of silica across an areola.

**Cribrum**—a velum perforated by regularly arranged pores.

**Foramen**—the passage through the constriction at the surface opposite the velum.

**Poroid areola or poroid**—an areola not markedly constricted at one surface of the valve.

**Loculate areola or loculus**—an areola markedly constricted at one surface of the valve and occluded by a velum at the other.

**Alveolus**—an elongated chamber running from the central part of the valve to margin, open to the inside and covered by a perforate layer on the outside.

**Stria**—one or more rows of areolae or pores, or an alveolus. Uniseriate, one row; biseriate, two rows; multiseriate, many rows.

**Interstria**—the nonperforate siliceous strip between two striae.

#### Processes (Figs. 6–8)

**Process**—projection with homogeneously silicified walls.

**Labiata process**—**rimoportula**—a tube or an opening through the valve wall with an internal flattened tube or longitudinal slit surrounded by two lips.

**Spine**—a closed or solid structure projecting out from the surface of the frustule.



**Marginal ridge**—a ridge between the valve face and the valve mantle, continuous or interrupted, perforated or solid especially in Lithodesmiaceae.

### Types of Colonies

**Separable colonies** (von Stosch, 1977)—cells connected by organic substances, separable into smaller units under appropriate conditions (e.g., in Lithodesmiaceae).

**Inseparable colonies** (von Stosch, 1977)—cells joined by fusion of, or by inseparable interlockings of, silica (e.g., in *Skeletonema*, *Chaetoceros*, and *Cymatosira*).

**Separation valve** (Florin, 1970)—valves where the separation of “inseparable” chains takes place with a structure and process pattern different from that of the other valves.

### Chains

*Thalassiosira*—by threads from strutted processes.

*Skeletonema*—by external parts of strutted processes.

*Leptocylindrus*—by abutting valve faces.

*Rhizosolenia*—by external part of the single labiate structure (process), contiguous area, and claspers.

*Eucampia*—by bipolar elevations.

*Cerataulina*—by bipolar elevations with spines.

*Chaetoceros*—by setae.

*Lithodesmium*—by marginal ridge.

### Ribbons

*Fragilariopsis*—by abutting valve faces.

*Cymatosira*—by marginal linking spines.

### Stepped chains

*Pseudo-nitzschia*—overlapping of cell ends.

### Zig zag or star-shaped chains

*Thalassionema*—mucilage pads.

---

**FIGURE 7** Fine structure of the siliceous valve wall and processes as seen with the scanning electron microscope. Scale bars for a, b, and d–g = 1  $\mu\text{m}$ ; for c = 10  $\mu\text{m}$ . (a) *Thalassiosira* sp., inside valve surface with cribra and trifultate strutted process; (b) *Thalassiosira* sp., inside valve surface with partially broken labiate process; (c and d) *Coscinodiscus* spp., central valve region seen from inside valve, internal foramina and external cribra and central unperforated (hyaline) area; (e) *Coscinodiscus* sp., marginal part of valve seen from the inside with foramina, six smaller and one larger labiate processes; (f and g) *Coscinodiscus* sp., marginal part of valve seen from the inside, foramina, smaller labiate processes and a larger process of a type different from the larger labiate process in 7e.

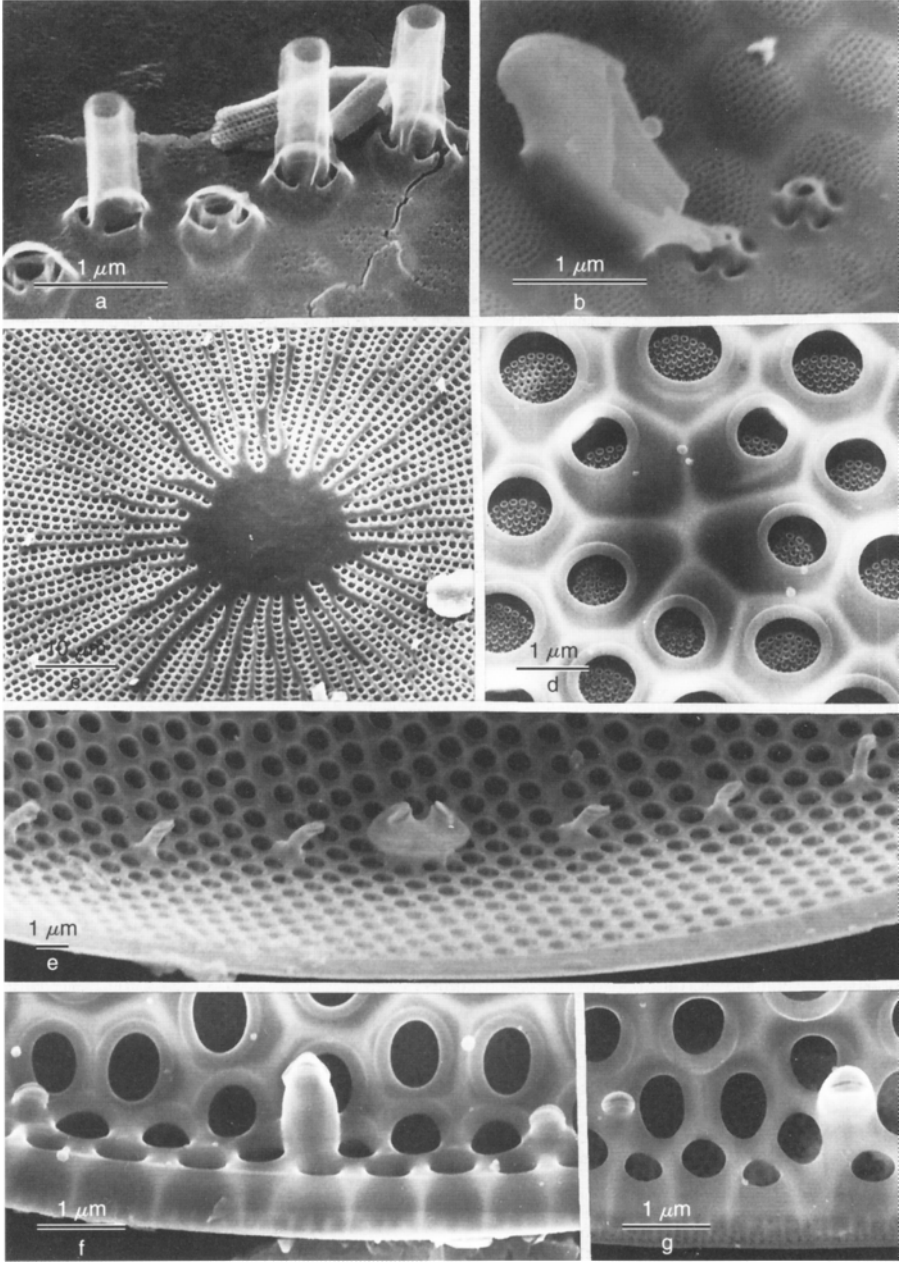

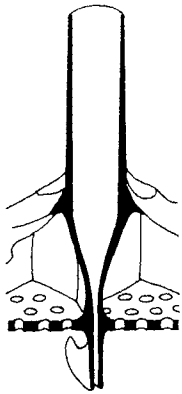

LABIATE PROCESS  
= RIMOPORTULA

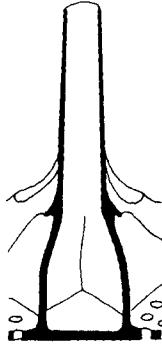

OCCLUDED PROCESS

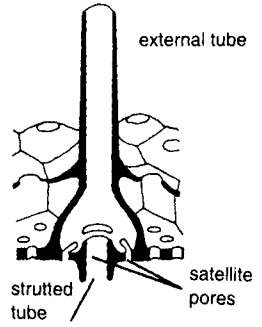

STRUTTED PROCESS  
= FULTOPORTULA

(see Thalassiosiraceae)

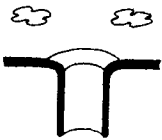

TUBULAR PROCESS  
(see Cymatosiraceae)

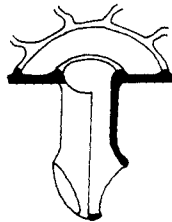

BILABIATE PROCESS  
(see Lithodesmiaceae)

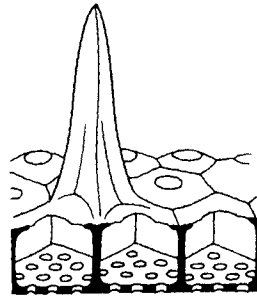

SPINE

FIGURE 8 Longitudinal sections of valve processes.

### CLASSIFICATION (Fig. 9)

Past and current classification systems for diatoms are mainly based on phenetic data confined to the structure and shape of the siliceous parts, especially the valves (see Round et al., 1990, pp. 117–121, for a discussion on diatom systematics). However, in recent schemes other kinds of characters have been added for consideration. For instance, the type of sexual reproduction and the structure of the auxospore envelope are considered distinctive features separating the centric and pennate diatoms (Simonsen, 1979; von Stosch, 1982). Round et al. (1990) also included the type of habitat (e.g., planktonic, epiphytic, marine, freshwater) as important in ordinal descriptions.

This chapter follows Simonsen (1979, p. 45) in dividing the centric diatoms into three suborders, each characterized by the shape of the cells, the polarity, and the arrangement of the processes (process pattern). The pennate diatoms are divided into two suborders, one including diatoms without a raphe, the other one encompassing taxa with a raphe. The further differentiation of the centric diatoms into families follows Simonsen (1979) in gross features, whereas the classification of the pennate diatoms is partially from Round et al. (1990).

## GENERA REPRESENTED IN MARINE PLANKTON

---

### CENTRIC DIATOMS

#### Order Biddulphiales

Valve striae arranged basically in relation to a point, an annulus, or a central areola.

#### Suborder Coscinodiscineae

Valves generally with a marginal ring of processes; symmetry primarily with no polarities.

#### Family Thalassiosiraceae Lebour 1930 emend. Hasle 1973

Genera: *Bacterosira* Gran; *Cyclotella* (Kützing), Brébisson; *Detonula* Schütt ex De Toni; *Lauderia* Cleve; *Minidiscus* Hasle; *Planktoniella* Schütt; *Porosira* Jørgensen; *Skeletonema* Greville; *Thalassiosira* Cleve.

#### Family Melosiraceae Kützing 1844

Genera: *Melosira* C. A. Agardh; *Paralia* Heiberg; *Stephanopyxis* (Ehrenberg) Ehrenberg.

#### Family Leptocylindraceae Lebour 1930

Genera: *Leptocylindrus* Cleve; *Corethron* Castracane.

#### Family Coscinodiscaceae Kützing 1844

Genera: *Coscinodiscus* Ehrenberg; *Ethmodiscus* Castracane; *Palmeria* Greville.

CENTRIC DIATOMS

Coscinodiscineae

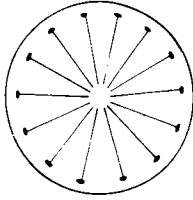

ring of processes

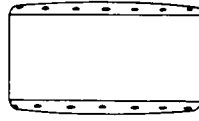

Rhizosoleniineae

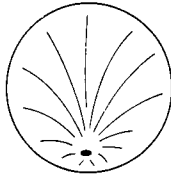

unipolar

apical axis



Biddulphiineae



bipolarity

elevations

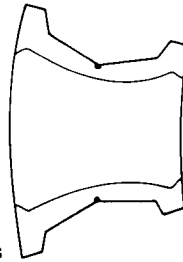

PENNATE DIATOMS

apical pore field

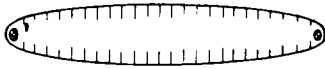

no raphe

Fragilarineae



raphe

Bacillariineae

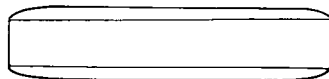

Family Stellarimaceae Nikolaev 1988 ex Sims & Hasle 1990

Genera: *Stellarima* Hasle & Sims.

*Incertae sedis*: *Gossleriella* Schütt

Family Hemidiscaceae Hendeby 1937 emend. Simonsen 1975 ex Hasle  
(this publication)

Genera: *Actinocyclus* Ehrenberg; *Azpeitia* M. Peragallo in  
Tempère & Peragallo, *Hemidiscus* Wallich; *Roperia* Grunow ex  
Pelletan.

*Incertae sedis*: *Pseudoguinaridia* von Stosch

Family Asterolampraceae H. L. Smith 1872 emend. Gombos 1980

Genera: *Asterolampra* Ehrenberg; *Asteromphalus* Ehrenberg.

Family Heliopeltaceae H. L. Smith 1872

Genera: *Actinoptychus* Ehrenberg; *Aulacodiscus* Ehrenberg.

Suborder Rhizosoleniineae

Valves primarily unipolar; no marginal ring of processes.

Family Rhizosoleniaceae De Toni 1890

Genera: *Rhizosolenia* Brightwell; *Proboscia* Sundström;  
*Pseudosolenia* Sundström; *Guinaridia* H. Peragallo; *Dactyliosolen*  
Castracane.

Suborder Biddulphiineae

Valves primarily bipolar; no marginal ring of processes.

Family Hemiaulaceae Heiberg 1863

Genera: *Cerataulina* H. Peragallo ex Schütt; *Climacodium* Grunow;  
*Eucampia* Ehrenberg; *Hemiaulus* Heiberg.

Family Cymatosiraceae Hasle, von Stosch, & Syvertsen 1983

Genera: *Arcocellulus* Hasle, von Stosch, & Syvertsen; *Brockmanniella*  
Hasle, von Stosch, & Syvertsen; *Cymatosira* Grunow; *Minutocellus*  
Hasle, von Stosch, & Syvertsen; *Plagiogrammopsis* Hasle, von Stosch,  
& Syvertsen.

*Incertae sedis*: *Lennoxia* Thomsen & Buck

Family Chaetocerotaceae Ralfs in Pritchard 1861

Genera: *Bacteriastrum* Shadbolt; *Chaetoceros* Ehrenberg; *Attheya* T.  
West.

---

**FIGURE 9** Schematic diagrams of centric and pennate diatom suborders with main features. Coscinodiscineae, valves with a marginal ring of processes, symmetry with no polarities; Rhizosoleniineae, valves unipolar, no marginal ring of processes; Fragilariineae, valves with sternum and no raphae; Bacillariineae, valve with sternum and raphe.

Family Lithodesmiaceae H. & M. Peragallo 1897–1908 emend.  
Simonsen 1979

Genera: *Bellerochea* Van Heurck emend. von Stosch; *Ditylum* J. W. Bailey ex L. W. Bailey; *Lithodesmioides* von Stosch; *Lithodesmium* Ehrenberg, *Helicotheca* Ricard; *Neostreptothea* von Stosch emend. von Stosch.

Family Eupodiscaceae Kützing 1849

Genus: *Odontella* C. A. Agardh.

## PENNATE DIATOMS

Order Bacillariales

Valve striae arranged basically in relation to a line

Suborder Fragilariineae—Araphid pennate diatoms

Sternum present (indistinct in one family)—Raphe absent.

Fragilariineae is used here for families belonging to several orders of the class Fragilariophyceae F. E. Round.

Family Fragilariaceae Greville 1833

Genera: *Asterionellopsis* F. E. Round in Round et al; *Bleakeleya* F. E. Round in Round et al.; *Striatella* C. A. Agardh; *Synedropsis* Hasle, Medlin, & Syvertsen + the species *Fragilaria striatula* Lyngbye.

Family Rhaphoneidaceae Forti 1912

Genera: *Adoneis* G. W. Andrews & P. Rivera; *Delphineis* G. W. Andrews; *Neodelphineis* Takano; *Rhaphoneis* Ehrenberg.

Family Toxariaceae F. E. Round in Round et al., 1990

Genus: *Toxarium* J. W. Bailey.

Family Thalassionemataceae F. E. Round (in Round et al., 1990)

Genera: *Lioloma* Hasle gen. nov., *Thalassionema* Grunow ex Mereschkowsky; *Thalassiothrix* Cleve & Grunow; *Trichotoxon* F. Reid & Round.

Suborder Bacillariineae—Raphid pennate diatoms: sternum and raphe present.

Bacillariineae is used here for families belonging to Achnanthales, Naviculales, and Bacillariales of the subclass Bacillariophycidae D. G. Mann.

Family Achnanthaceae Kützing 1844

Genus: *Achnanthes* Bory de St.-Vincent.

Family Phaeodactylaceae J. Lewin 1958

Genus: *Phaeodactylum* Bohlin.

*Incertae sedis*: *Nanoneis* R. E. Norris

## Family Naviculaceae Kützing 1844

Genera: *Meuniera* P. C. Silva nom. nov., *Navicula* Bory de St. Vincent; *Haslea* Simonsen; *Pleurosigma* W. Smith; *Ephemera* Paddock; *Banquisia* Paddock; *Membraneis* Paddock; *Manguinea* Paddock; *Plagiotropis* Pfitzer emend. Paddock; *Pachyneis* Simonsen.

## Family Bacillariaceae Ehrenberg 1831

Genera: *Bacillaria* Gmelin; *Cylindrotheca* Rabenhorst; *Fragilariopsis* Hustedt in A. Schmidt, 1990; *Neodenticula* Akiba & Yanagisawa; *Pseudo-nitzschia* H. Peragallo in H. & M. Peragallo, 1897–1908; *Nitzschia* Hassall.

## IDENTIFICATION

The emphasis of this chapter in general is oriented toward routine identification of genera and species by investigators primarily using light microscopy. The species dealt with are a selection of those which, according to the literature and our own experience, are regularly encountered in marine plankton.

Identification of diatoms usually must rely on the siliceous frustule. Shape, size, number, and arrangement of chloroplasts and the presence or absence of pyrenoids may, however, be used for identification on the generic and specific level. This is especially true in pennate diatoms (Cox, 1981) and for the centric genera *Chaetoceros* and *Leptocylindrus*. For example, many species of *Chaetoceros* and *Rhizosolenia* may be identified by their gross morphology as seen in water mounts or when embedded in a medium of higher refractive index than that of silica. The proper identification of other species, such as *Thalassiosira*, *Coscinodiscus*, and *Pseudo-nitzschia*, may require permanent mounts of cleaned single valves (see Methodology). Phase and/or differential interference contrast optics are especially helpful when working with weakly silicified diatoms.

## CONTENT

Some families consist of more genera than those dealt with in this chapter. In these cases, only characters common to the genera presented are listed. Keys to genera and/or a list of generic characters (for monotypic genera the description of the generic type) characterize each genus. Keys to species and/or a list of characters distinguishing the species of a certain genus describe each species. For the larger genera the species are grouped (A, B, C, etc.) according to a few common characters.

When up to date information from the literature is lacking, morphometric and distributional data from Hustedt (1930, 1959, 1961), Cupp (1943), Hen-



dey (1964), and the authors personal observations are given. Few planktonic species and localities have been regularly investigated over a longer period of time. It is therefore seldom worthwhile to go into detail concerning species distribution. We accordingly confine ourselves to the simplest system, viz. three main biogeographical provinces as distinguished for marine plankton communities by Zeitzschel (1982). These are the circumglobal warm water region, a northern cold water region, and a southern cold water region. This classification is fairly consistent with the results of a detailed investigation of 26 marine planktonic diatom species (Hasle, 1976a). The diatoms classified as “cold water” species are often associated with sea ice. Those classified as “warm water” species may have a much wider latitudinal range than that of the warm water region due to transport by currents out of their reproduction areas.

The catalogue by VanLandingham (1967–1979), although not always followed, was consulted for references to publications and synonyms. The generitypes are from Farr et al. (1979, 1986), Greuter et al. (1993), and from more recent literature with some modifications (P. C. Silva, personal communication). The types are cited as they were originally named. In cases of synonymy, the names now regarded as the correct names (the names recommended to be used) are also listed.

Taxa, names, and combinations previously unpublished and used under Description of Taxa are formally described in the Taxonomic Appendix.

The synonymy list is meant as an aid to avoid confusion concerning names commonly used in the literature. Principally, one or more common synonyms, not necessarily including the basionym, are presented. In general, synonymy information too recent to be found in Hustedt (1930, 1959, 1961), Cupp (1943), and Hendey (1964) has been updated. For further information the reader is referred to these publications as well as to synonyms and literature references in the present chapter.

As for the plates presented in this chapter, the sources are given for figures redrawn from the literature; if no source is indicated, the figure is original. In the Thalassiosiraceae, strutted processes are illustrated by a dot, sometimes with a short line attached to indicate the longer extension of the process, and labiate processes are illustrated by a line. In other diatoms, the labiate processes are illustrated by dots, triangles, etc. depending on their relative size and shape. In a series of figures with the same magnification, the scale bar is marked only for the first figure.

## **DESCRIPTION OF TAXA**

---

### **CENTRIC DIATOMS**

#### **Order Biddulphiales**

Terminology specific to centric diatoms (Fig. 10)

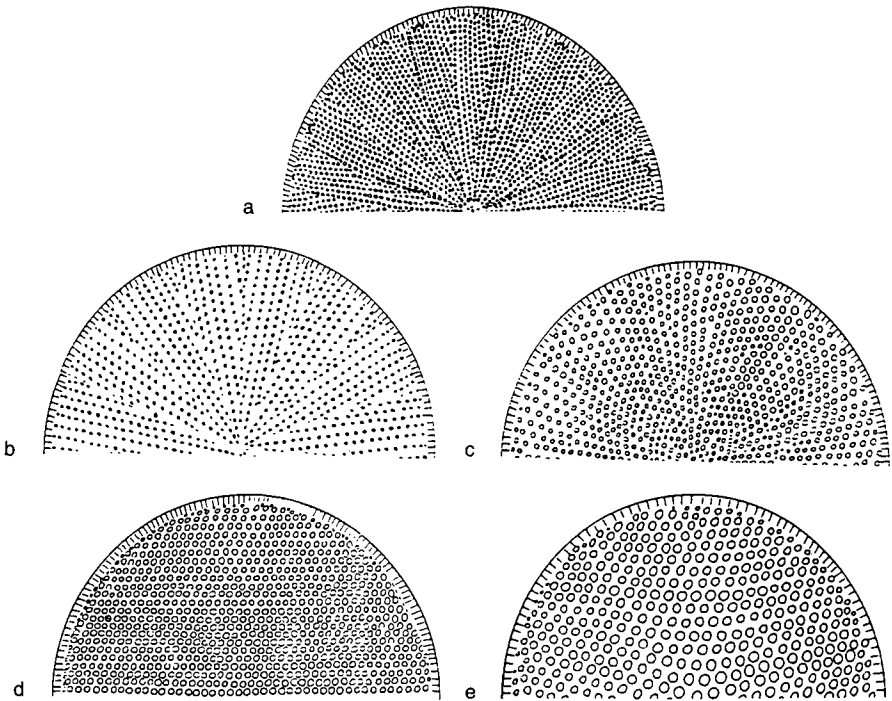

FIGURE 10 Valve striation in centric diatoms; (a) fasciculation (“curvatus” type), striae parallel with long edge stria of the bundle; (b) fasciculation, striae parallel with long central stria; (c) radial striae, running from the center toward the margin of the valve with shorter striae inserted; (d) tangential straight striae; (e) tangential curved striae.

### Striae

Radial striae run from the center of the valve toward the margin (Fig. 10c).

Decussating arcs—spiraling rows of areolae.

Fasciculate striae are grouped in bundles (sectors, fascicles) and are parallel to a radial stria, either the edge stria of the bundle (Fig. 10a) or the central stria (Fig. 10b).

Tangential striae are either straight (Fig. 10d) or curved (Fig. 10e).

### Suborder Coscinodiscineae

#### Family Thalassiosiraceae Lebour 1930 emend. Hasle 1973

The family, as delineated by Simonsen (1979), comprises marine as well as freshwater planktonic diatoms, all having strutted processes as the main morphological, taxonomic character. The genera dealt with in this chapter were classified into two families by Glezer et al. (1988)—Thalassiosiraceae

Lebour emend. Hasle and Stephanodiscaceae Makarova, order Thalassiosirales—and into four families by Round et al. (1990)—Thalassiosiraceae Lebour, Skeletonemataceae Lebour emend. Round et al., Stephanodiscaceae Glezer & Makarova and Lauderiaceae (Schütt) Lemmermann emend. Round et al., order Thalassiosirales Glezer & Makarova, subclass Thalassiosirophyceidae Round & Crawford. Silva & Hasle (1994) proposed conservation of Thalassiosiraceae against Lauderiaceae and Planktoniellaceae (Schütt) Lemmermann.

Terminology specific to Thalassiosiraceae: (Figs. 6–8, scanning electron microscopy)

**Strutted process**—fultoportula—a process through which a thread of organic material (mostly chitan, as far as is known) is extruded, consisting of (1) a narrow tube through the basal siliceous layer (“strutted tube”) surrounded by struts and satellite pores and (2) “the external tube” which may be missing except for the basal chamber (Syvertsen & Hasle, 1982). Special terms: “operculate” and “trifultate” strutted processes (Fryxell & Hasle, 1979a, p.378).

**Occluded process**—hollow external tube not penetrating the valve wall, sometimes (always?) at the top of an areola (Syvertsen & Hasle, 1982).

The genera treated here are characterized by:

Cells in chains or embedded in mucilage.

Cells in chains linked by threads of organic matter from **strutted processes** or by external tubes of marginal strutted or **occluded processes**.

Valve outline circular.

Valve surface thin radial costae, rows of poroids or loculate areolae, or alveoli.

External parts of processes usually more conspicuous than the internal parts.

One or a few labiate processes.

Internal cribra and external foramina (SEM).

Chloroplasts small, rounded bodies.

Resting spores/cells present.

#### KEY TO GENERA

- 1a. Valves with one to three marginal rings of strutted processes. . . . . 2
- 1b. Processes away from valve margin. . . . . *Minidiscus*, p. 37
- 2a. Girdle with organic extrusions . . . . . *Planktoniella*, p. 39
- 2b. Girdle with no such extrusions . . . . . 3
- 3a. Valve wall alveolate . . . . . *Cyclotella*, p. 33
- 3b. Valve surface with loculate areolae or radial ribs; not alveolate . . . . 4

- 4a. Chain formation by external tubes of marginal strutted processes . . . 5  
 4b. Chain formation by threads from strutted processes . . . . . 6  
 5a. Central process present . . . . . *Detonula*, p. 34  
 5b. No central strutted process . . . . . *Skeletonema*, p. 43  
 6a. Strutted processes organized in a pattern on valve face . . . . . 7  
 6b. Strutted processes scattered on valve face, no particular central processes  
 or central processes rudimentary (EM) . . . . . 8  
 7a. Adjacent cells in chains abutting . . . . . *Bacterosira*, p. 31  
 7b. Cells in chains separated by shorter or longer distance, or cells solitary or  
 embedded in mucilage . . . . . *Thalassiosira*, p. 45  
 8a. Long occluded processes, central processes rudimentary or missing, valve  
 structure mainly consisting of radial ribs. . . . . *Lauderia*, p. 36  
 8b. Occluded processes absent, valve surface areolated . . . . *Porosira*, p. 41

**Remarks:** Strutted processes from which linking threads are extruded may be situated (1) exactly in valve center inside an areola (seldom) or an annulus, (2) next to a central areola (often) or an annulus, or (3) somewhere between valve center and margin, in some species in a more or less modified ring. Central and subcentral processes thus stand for “strutted processes through which interconnected threads instrumental in chain formation may be extruded.”

**Genus *Bacterosira*** Gran 1900

**Type:** *Bacterosira fragilis* (Gran) Gran.

**Correct name:** *Bacterosira bathyomphala* (Cleve) Syvertsen & Hasle (*vide* Hasle & Syvertsen, 1993, p. 298).

Monospecific genus.

***Bacterosira bathyomphala*** (Cleve) Syvertsen & Hasle (Plate 1)

**Basionym:** *Coscinodiscus bathyomphalus* Cleve.

**Synonyms:** *Lauderia fragilis* Gran; *Bacterosira fragilis* (Gran) Gran.

**References:** Cleve, 1883, p. 489, Plate 38, Fig. 81; Gran, 1897a, p. 18, Plate 1, Figs. 12–14; Gran, 1900, p. 114; Hustedt, 1930, p. 544, Fig. 310; Hendeby, 1964, p. 141, Plate 7, Fig. 5; Hasle, 1973a, p. 27, Fig. 88; Hasle & Syvertsen, 1993, p. 298.

**Girdle view:** Tight chains by abutting valve faces. Pervalvar axis usually longer than cell diameter. Apparent lens-shaped structure between cells. Cell wall weakly silicified.

**Valve view:** Cluster of central processes. One marginal ring of small strutted processes, one marginal labiate process. Radial ribs from valve center toward valve margin.

**Resting spores:** Semiendogenous, heterovalvate, primary valve with flattened valve face, secondary valve highly elevated in the center, first described as *Coscinodiscus bathyomphalus* (Cleve, 1883).

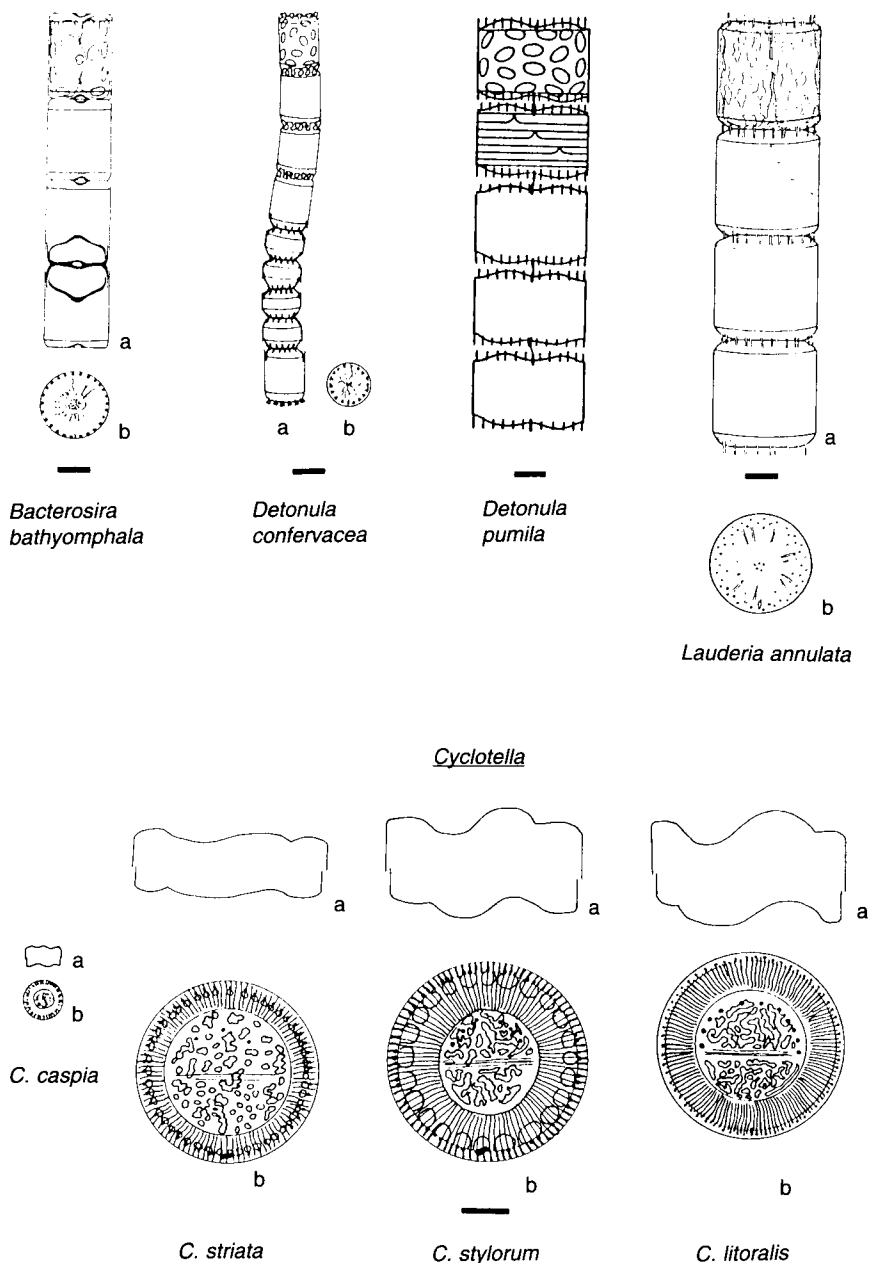

PLATE 1 *Bacteriosira bathyomphala*: (a) chain in girdle view including two semiendogenous resting spores, lenticular openings between cells; (b) single valve of vegetative cell. *Detonula confervacea*: (a) chain in girdle view with four exogenous resting spores; (b) single valve of vegetative cell. *Detonula pumila*: chain in girdle view showing central process and thread between cells and marginal processes. *Lauderia annulata*: (a) chain in girdle view; (b) valve with many strutted and occluded processes and one labiate process. *Cyclotella caspia*, *C. striata*, *C. stylorum*, and *C. litoralis*: (a) single cells in girdle view showing undulations of valves; (b) single valves with structure. Scale bars = 10  $\mu\text{m}$ .

**Morphometric data:** Diameter 18–24  $\mu\text{m}$ , more than 30 radial ribs in 10  $\mu\text{m}$ , five to seven marginal strutted processes in 10  $\mu\text{m}$ .

**Distribution:** Northern cold water region.

**How to identify:** *Bacterosira* and *Thalassiosira* may be confused as single valves but are readily distinguished in water mounts in chains.

**Genus *Cyclotella*** (Kützing 1833) Brébisson 1838 (Plate 1, Table 1)

**Type:** *Cyclotella tecta* Håkansson & Ross.

**Correct name:** *Cyclotella distinguenda* Hustedt (*vide* Håkansson, 1989, p. 266).

**References:** Kützing, 1844, p. 131, Plate 1, Fig. 8; Brightwell, 1860, p. 96, Plate 6, Fig. 16; Grunow, 1878, p. 126, Plate 4, Fig. 19; Cleve & Grunow, 1880, p. 119; Hustedt, 1930, p. 334, Figs. 176, 177, and 179; Håkansson & Ross, 1984; Nagumo & Ando, 1985; Nagumo & Kobayasi, 1985; Håkansson, 1989; Lange & Syvertsen, 1989; Takano, 1990, pp. 166–167; Sancetta, 1990, Plate 1, Figs. 1–3.

Most *Cyclotella* species belong to freshwater. Detailed morphological, taxonomic studies of the species found in brackish water/marine environments are sparse (Lange & Syvertsen, 1989). Species often recorded from marine plankton are *C. caspia*, *C. litoralis* (as *C. striata* and/or *C. stylorum*), *C. meneghiniana* Kützing (often as *C. cryptica* Reimann, Lewin, & Guillard), *C. striata*, and *C. stylorum*.

Generic characters:

Cells usually solitary.

Valves tangentially undulated.

Valve wall alveolate.

A central field distinctly different from the rest of the valve.

One to many strutted processes within the central field.

Central field reticulate rugose or with warts or granules.

One marginal ring of strutted processes.

One marginal labiate process.

Characters showing differences between species:

The presence or absence of marginal chambers [= marginal spaces on the inside of the valve encompassing two or more alveolus openings (see Fig. 5)].

Location of marginal strutted processes versus interstriae.

Degree of undulation.

TABLE 1 Morphometric Data of *Cyclotella* spp.

Species	Diameter ( $\mu\text{m}$ )	Striae in 10 $\mu\text{m}$
<i>C. caspia</i>	3.5–22	20–28
<i>C. litoralis</i>	10–60	9–14
<i>C. striata</i>	25–48	8–11
<i>C. stylorum</i>	35–67	9–12

## KEY TO SPECIES

- 1a. Undulation of valve pronounced . . . . . 2  
 1b. Undulation of valve evident but not pronounced. . . . . 3  
 2a. A marginal strutted process on every second, occasionally on every interstria; valve without marginal chambers. . . *C. litoralis* Lange & Syvertsen  
 2b. Marginal strutted processes grouped in pairs or triplets; valve with prominent marginal chambers covering three or four alveolus openings . . . . .  
 . . . . . *C. stylorum* Brightwell  
 3a. A marginal strutted process on every second to fourth interstria; valve with marginal chambers covering two alveolus openings. . . . .  
 . . . . . *C. striata*<sup>1</sup> (Kützing) Grunow in Cleve & Grunow  
 3b. A marginal strutted process on every third or fourth interstria; valve without marginal chambers . . . . . *C. caspia* Grunow

## Distribution:

*C. caspia*—northern temperate region, euryhaline.

*C. litoralis*—southern and northern temperate region, coastal, marine (Lange & Syvertsen, 1989; Sancetta, 1990).

*C. striata*—northern temperate region, littoral.

*C. stylorum*—warm water region to southern temperate region, littoral.

**How to identify:** The species may be identified with light microscopy (LM) as cleaned valves mounted in a medium of a high refractive index.

**Remarks:** Nagumo & Ando (1985) made a comparative study of *C. stylorum* and a species identified as *Cyclotella* sp. The latter is most likely *C. litoralis*.

**Genus *Detonula*** Schütt ex De Toni 1894 (Plate 1, Table 2)

**Lectotype:** *Detonula pumila* (Castracane) Gran (*vide* Round et al., 1990, p. 142).

**Basionym:** *Lauderia pumila* Castracane.

**Synonyms:** *Schroederella delicatula* Pavillard, *Thalassiosira condensata* Cleve (for other synonyms see Hasle, 1973a, p. 18).

<sup>1</sup> Basionym: *Coscinodiscus striatus* Kützing.

TABLE 2 Morphometric Data of *Detonula* spp.

Species	Pervalvar axis ( $\mu\text{m}$ )	Diameter ( $\mu\text{m}$ )	Marginal processes in 10 $\mu\text{m}$	Areolae in 10 $\mu\text{m}$
<i>D. confervacea</i>	15–30	6–20	10	30–40
<i>D. pumila</i>	15–120	16–30	6–8	ca. 20
<i>D. moseleyana</i>	60–212	28–120	8–12	21–28

**References:** Castracane, 1886, pp. 89, 90, Plate 9, Fig. 8, Plate 24, Fig. 9; Cleve, 1896a, p. 11, Plate 2, Fig. 21 (no number on the plate); Schütt, 1896, p. 83, Fig. 135; Gran, 1900, p. 113, Plate 9, Figs. 15–20; Pavillard, 1913, p. 126, Fig. 1a; Hustedt, 1930, pp. 551 and 554, Figs. 314 and 315; Cupp, 1943, p. 76, Fig. 36; Hendeby, 1964, p. 142, Plate 5, Fig. 4, Plate 7, Fig. 6, p. 143, Plate 7, Fig. 7; Hasle, 1973a, pp. 15–27, Figs. 44–86; Syvertsen, 1979, p. 55, Figs. 63–69; Round et al., 1990, pp. 142–143; Takano, 1990, pp. 168–169.

Generic characters:

Tight chains.

Cylindrical cells.

Weakly silicified vegetative valves.

Valve surface with radial ribs and few well-developed areolae.

One central strutted process.

One marginal ring of strutted processes.

One marginal labiate process.

Characters showing differences between species:

Size of pervalvar axis and diameter.

Shape of external tubes of marginal strutted processes (SEM).

Size of labiate process.

Presence or absence of resting spore formation.

Hasle (1973a) distinguished between three *Detonula* species. *Detonula confervacea* (Cleve) Gran (basionym: *Lauderia confervacea*) and *D. pumila* are common in marine plankton, while there are few records in the literature of the much larger *D. moseleyana* (Castracane) Gran (basionym: *Lauderia moseleyana* Castracane). The single connecting thread from a strutted process in a central valve depression is usually conspicuous in *D. pumila* and less so in *D. confervacea*. *Detonula pumila* is also distinguished from *D. confervacea*



by the longer external tubes of the marginal strutted processes linked in a distinct zig zag pattern. The external tubes of *D. confervacea* are laterally expanded into a T shape, whereas those of *D. pumila* and *D. moseleyana* have the shape of half tubes. The marginal labiate process of *D. pumila* is smaller than that in the two other species, and *D. moseleyana* differs from *D. pumila* mainly by its greater diameter.

**Distribution:**

*D. confervacea*—northern cold water region to northern temperate.

*D. pumila*—probably cosmopolitan with a preference for warmer waters.

*D. moseleyana*—Indian Ocean.

**How to identify:** The species may be distinguished in girdle view in water mounts especially by their size (Table 2).

**Remarks:** Based on Cleve's (1900a, p. 22, Plate 8, Figs. 12 and 13) original description of *Thalassiosira condensata* as well as on the description and illustrations of the species in Lebour (1930, p. 63, Fig. 35) and Hendeby (1937, p. 238, Plate 11, Fig. 11) we suggest that this species also should be put into synonymy with *D. pumila*. Resting spores (exogenous) are common in *D. confervacea* and not reported for the two other species. The resting spore valves are coarsely areolated and smoothly curved, similar to the valves of *Thalassiosira* spp. with one central process. The external tubes of the marginal strutted processes lack the lateral expansions linking vegetative cells together. Chains of *D. confervacea* of maximum size and *Bacterosira bathyomphala* are similar, both having many chloroplasts and a short or no distance between adjacent cells. The distinction is seen by paying attention to the external parts of the marginal strutted processes of end valves of *D. confervacea* chains, visible with LM in this species but not in *B. bathyomphala*.

**Genus *Lauderia*** Cleve 1873

**Type:** *Lauderia annulata* Cleve.

Monospecific genus.

***Lauderia annulata*** Cleve (Plate 1)

**Synonym:** *Lauderia borealis* Gran.

**References:** Cleve, 1873a, p. 8, Plate 1, Fig. 7; Gran, 1900, p. 109, Plate 9, Figs. 1–8; Hustedt, 1930, p. 549, Fig. 313; Cupp, 1943, p. 74, Fig. 35; Hasle, 1973a, p. 3, Figs. 1–3; Syvertsen & Hasle, 1982; Takano, 1990, pp. 170–171.

**Girdle view:** Cells in chains fairly close (separated by occluded processes on marginal part of valve). Pervalvar axis slightly longer than diameter.

**Valve view:** Valve surface with faint radial ribs. Prominent central annulus, sometimes with a few processes. A large marginal labiate process. Numerous strutted processes on valve face and margin. Long

occluded processes in marginal zone (types of processes not differentiated with LM).

**Morphometric data:** Cell diameter 24–75  $\mu\text{m}$ , perivalvar axis 26–96  $\mu\text{m}$ , more than 30 radial ribs in 10  $\mu\text{m}$  on valve face.

**Distribution:** Warm water region to temperate.

**How to identify:** Whole cells of *B. bathyomphala*, *D. pumila* and *Lauderia annulata* are distinguished in water mounts by the way the cells are linked together in chains. At a certain focus, adjacent cells of *B. bathyomphala* seem to be separated by a central lenticular opening. The external structures of the marginal strutted processes of *D. pumila* are linked midway between adjacent valves, and the tubular occluded processes of *L. annulata* run from one adjacent valve to the next. In critical cases cleaned valves mounted in a medium of a high refractive index may be examined to show the differences in process patterns.

**Genus *Minidiscus*** Hasle 1973 (Plate 2, Table 3)

**Type:** *Minidiscus trioculatus* (F. J. R. Taylor) Hasle.

**Basionym:** *Coscinodiscus trioculatus* F. J. R. Taylor.

**References:** Taylor, 1967, p. 437, Plate 5, Fig. 43; Hasle, 1973a, p. 29, Figs. 101–108; Takano, 1981; Rivera & Koch, 1984; Takano, 1990, pp. 172–175; Sancetta, 1990, Plate 1, Figs. 5 and 6.

Generic characters:

Usually observed as single cells.

Valves with a more or less prominent hyaline margin.

Mantle usually high.

Processes more or less concentrated in valve center.

#### KEY TO SPECIES

- 1a. Hyaline valve margin prominent . . . . . 2
- 1b. Hyaline valve margin missing or extremely narrow . . . . .  
     . . . . . *M. comicus* Takano
- 2a. Processes close together in a nonareolated, undulated central part. . . . .  
     . . . . . *M. chilensis* Rivera
- 2b. Processes separated by one to several areolae . . . . .  
     . . . . . *M. trioculatus* (F. J. R. Taylor) Hasle

**Distribution:**

*M. comicus*—described from Japanese waters (Takano, 1981) and recorded from Argentine waters (Lange, 1985), the English Channel, the Adriatic, and the Gulf of Mexico (G. Hasle and E. Syvertsen, unpublished observations).

*Minidiscus*

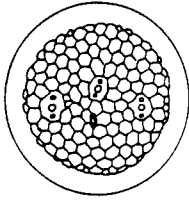

*M. trioculatus*

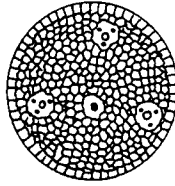

*M. comicus*

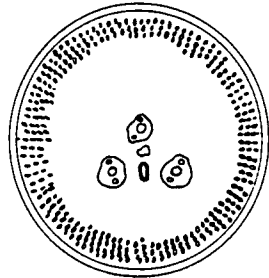

*M. chilensis*

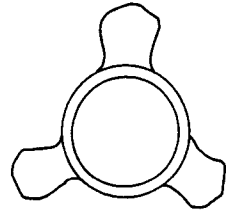
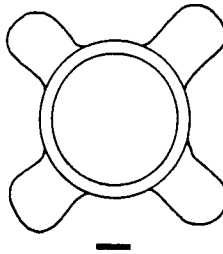
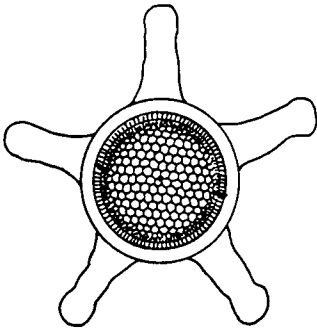

*Planktoniella blanda*

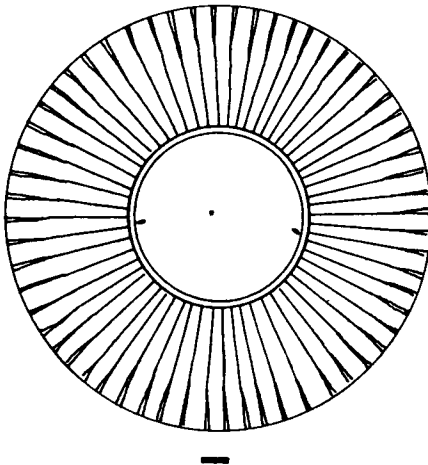

*Planktoniella sol*

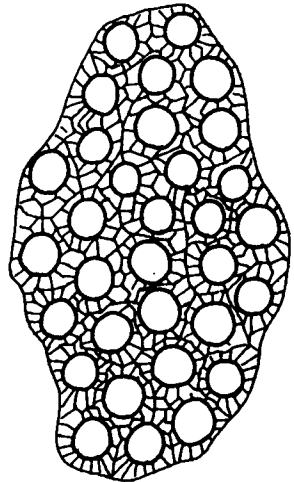

*Planktoniella muriformis*

TABLE 3 Morphometric Data of  
*Minidiscus* spp.

Species	Pervalvar axis ( $\mu\text{m}$ )	Diameter ( $\mu\text{m}$ )
<i>M. comicus</i>	2–3?	1.9–7.0
<i>M. chilensis</i>	1.4–3.0	3.0–7.5
<i>M. trioculatus</i>	3.0–5.5	2.0–5.0

*M. chilensis*—described from Chile (Rivera & Koch, 1984) and recorded from localities in the Pacific as well as the Atlantic Oceans between ca. 60°N and 50°S (Sancetta, 1990, and Hasle and Syvertsen, unpublished observations) and off the Argentine coast (Ferrario, 1988).

*M. trioculatus*—described from the Indian Ocean and regarded as cosmopolitan in distribution (Hasle, 1973a).

**How to identify:** *Minidiscus* spp. belong to the smallest known planktonic, centric diatoms. Due to the small size they can hardly be identified to species with LM. With electron microscopy (EM) they are distinguished by differences in areolation and location of the processes.

**Remarks:** Since these species are numerically important in marine nanoplankton but easily overlooked, their worldwide distribution is still uncertain.

#### Genus *Planktoniella* Schütt 1892 (Plate 2, Table 4)

**Type:** *Planktoniella sol* (Wallich) Schütt.

**Basionym:** *Coscinodiscus sol* Wallich.

**References:** Wallich, 1860, p. 38, Plate 2, Fig. 1; Schmidt, 1878, Plate 59, Figs. 35–37; Schütt, 1892, p. 258, Fig. 64; Hustedt, 1930, p. 464, Fig. 259; Cupp, 1943, p. 63, Fig. 27; Loeblich et al., 1968; Fryxell & Hasle, 1972, Figs. 34–36; Round, 1972; Desikachary, 1989, p. 9, Plates 742–744; Hallegraeff, 1992, Figs. 1–12; Hasle & Syvertsen, 1993, p. 303, Figs. 17–31.

PLATE 2 *Minidiscus trioculatus*, *M. comicus*, and *M. chilensis*: Single valves. Structure seen with EM. Scale bar = 1  $\mu\text{m}$ . *Planktoniella blanda*: cells in valve view having varying number of lobes; cell to the left with areolation and process pattern. Scale bar = 10  $\mu\text{m}$ . *Planktoniella sol*: cell in valve view with wing, central strutted process, and two marginal labiate processes. Scale bar = 10  $\mu\text{m}$ . *Planktoniella muriformis*: colony of many cells in valve view connected by an organic matrix. Scale bar = 10  $\mu\text{m}$ .

TABLE 4 Morphometric Data of *Planktoniella* spp.

Species	Diameter ( $\mu\text{m}$ )	Areolae in 10 $\mu\text{m}$	Marginal proc. in 10 $\mu\text{m}$	No. of labiate proc.
<i>P. blanda</i>	25–55	3–4	3–4	2
<i>P. muriformis</i>	11–15	18–24	7–9	1
<i>P. sol</i>	10–60	5–9	4–5	2

Note. Proc., processes.

#### Generic characters:

- Cells discoid.
- Organic extrusions from the girdle.
- Radial or tangential areolation.
- One central strutted process.
- One marginal ring of processes.
- One or two labiate processes.

#### KEY TO SPECIES

- 1a. Cells usually solitary, occasionally connected by a thread from a central strutted process . . . . . 2
- 1b. Cells in a matrix extruded from the girdle forming sheet like colonies . . . . . *P. muriformis*<sup>2</sup> (Loeblich, Wight, & Darley) Round
- 2a. Girdle with a continuous wing . . . . . *P. sol* (Wallich) Schütt
- 2b. Girdle with lobes. . . . . *P. blanda*<sup>2</sup> (A. Schmidt) Syvertsen & Hasle

**Distribution:** Warm water region (*P. sol* has also been recorded in Atlantic waters in the Norwegian Sea and along the Norwegian west coast).

**How to identify:** Since the organic material attached to the girdle disappears during acid cleaning, *Planktoniella* spp. are easily misidentified as *Thalassiosira* spp. when cleaned, mounted valves are examined.

Examination of water mounts is therefore more reliable.

**Remarks:** *Coscinodiscus blandus* Schmidt (1878) as well as *C. latimarginatus* Guo (1981) were described with lobes attached to the girdle. The combination *Thalassiosira blandus* (sic!) Desikachary & Gowthaman

<sup>2</sup> Basionyms: *Coenobiodiscus muriformis* Loeblich, Wight, & Darley and *Coscinodiscus blandus* A. Schmidt, respectively.

appeared in Desikachary (1989, p. 9), evidently based on LM observations. The valve gross morphology of *C. blandus* as resolved with SEM is much the same as those in *Thalassiosira* and *Planktoniella*. The justification for the combination *Planktoniella blanda* is the fact that organic extrusions from the girdle (in this case the lobes) are present in *Planktoniella* but not in *Thalassiosira*. Hallegraeff (1992) apparently regarded *C. blandus* A. Schmidt and *C. bipartitus* Rattray as two separate taxa and made the new combination, *Thalassiosira bipartita* (Rattray) Hallegraeff. *Thalassiosira simonsenii* Hasle & G. Fryxell has occluded processes but may even so belong to this genus, possibly as conspecific with *P. blanda*.

### Genus *Porosira* Jørgensen 1905 (Plate 3, Table 5)

**Type:** *Porosira glacialis* (Grunow) Jørgensen.

**Basionym:** *Podosira hormoides* var. *glacialis* Grunow.

**References:** Grunow, 1884, p. 108, Plate 5, Fig. 32; Jørgensen, 1905, p. 97, Plate 6, Fig. 7; Hustedt, 1930, p. 314, Fig. 153; Hustedt, 1958a, p. 117, Figs. 20 and 21; Jousé et al., 1962, p. 66, Plate 4, Figs. 15 and 17; Simonsen, 1974, p. 11, Plates 7 and 8; Hasle, 1973a, pp. 6–15, Figs. 4, 5, and 13–43; Takano, 1990, pp. 176–177; Syvertsen & Lange, 1990.

#### Generic characters:

- Cells single or in loose chains.
- Cells discoid.
- A central annulus.
- Radial areolation.
- One large labiate process in the marginal zone.
- Numerous (strutted) processes all over the valve face.

#### KEY TO SPECIES

- 1a. Valve areolae distinct, central annulus mostly indistinct . . . . . 2
- 1b. Valve areolae indistinct, striae wavy, annulus distinct . . . . . 3
- 2a. Radial and spiraling striae, external part of labiate process short . . . . .  
 . . . . . *P. pseudodenticulata*<sup>3</sup> (Hustedt) Jousé
- 2b. Areolation fasciculate, external part of labiate process long. . . . .  
 . . . . . *P. denticulata* Simonsen
- 3a. Labiate process close to the valve margin with two small strutted processes  
 on a radial line on each side. . . . . *P. pentaportula* Syvertsen & Lange
- 3b. Labiate process at some distance from the valve margin, no regular arrange-  
 ment of strutted processes close to the labiate process . . . . .  
 . . . . . *P. glacialis* (Grunow) Jørgensen

<sup>3</sup> Basionym: *Coscinodiscus pseudodenticulatus* Hustedt.

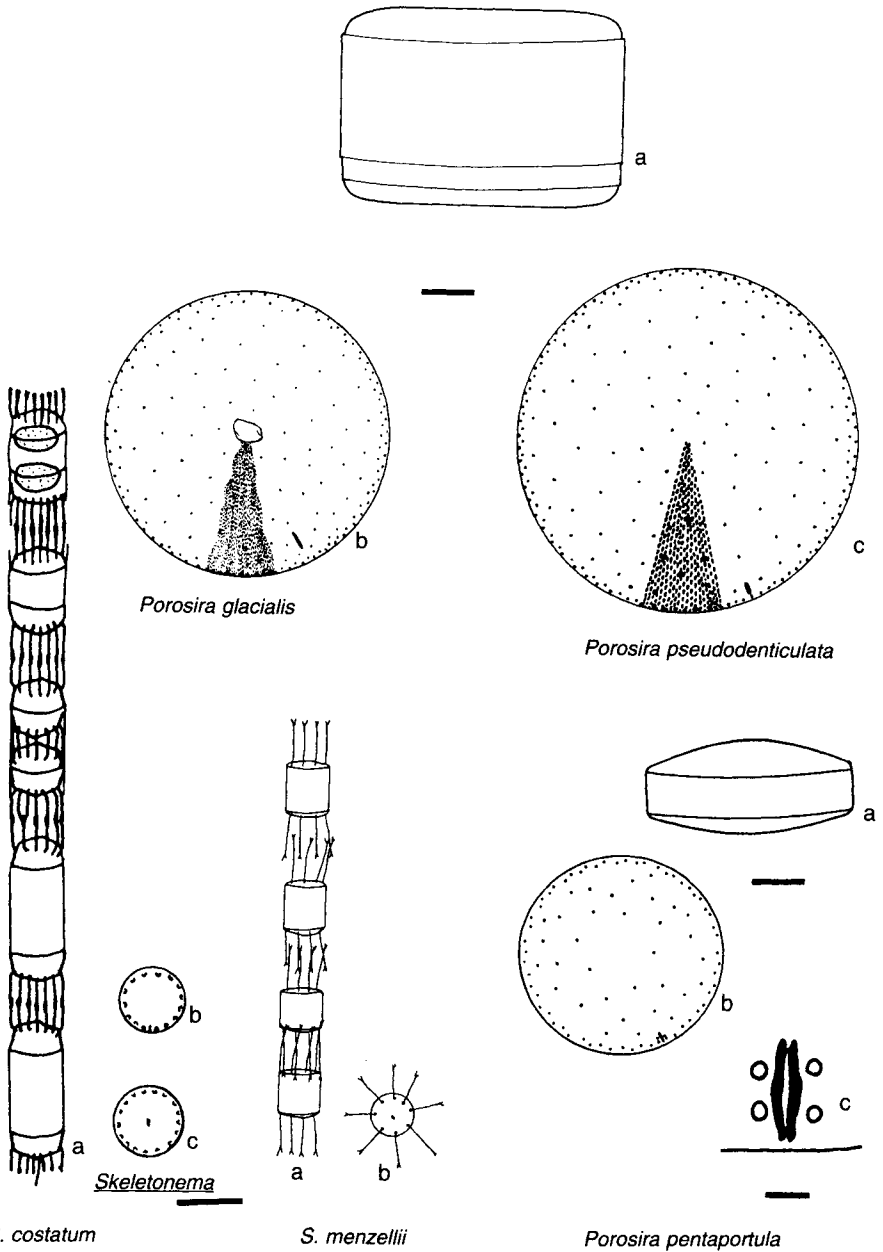

PLATE 3 *Porosira glacialis* and *P. pseudodenticulata*: (a) single cell in girdle view; (b) *P. glacialis* valve with central annulus, processes, and sector with wavy areolation; (c) *P. pseudodenticulata* with straight rows of areolae and no annulus. *Porosira pentaportula*: (a) single cell in girdle view; (b) valve with process pattern; (c) detail, labiate process with two strutted processes on each side.

TABLE 5 Morphometric Data of *Porosira* spp.

Species	Pervalvar axis ( $\mu\text{m}$ )	Diameter ( $\mu\text{m}$ )	Areolae in 10 $\mu\text{m}$
<i>P. denticulata</i>	— <sup>a</sup>	50–170	14–20
<i>P. glacialis</i>	36–64	30–40	25–26
<i>P. pentaportula</i>	20–25	25–50	ca. 30
<i>P. pseudodenticulata</i>	—	60–80	10–12

<sup>a</sup> —, No data.

### Distribution:

*P. denticulata*—Indian Ocean, Equatorial Atlantic Ocean (?) (Simonsen, 1974, probably the only records).

*P. glacialis*—northern cold water region to temperate, southern cold water region.

*P. pentaportula*—off Uruguayan and Brazilian coasts, off Norwegian south coast (Syvertsen & Lange, 1990), Rhode Island (Hargraves, personal communication).

*P. pseudodenticulata*—southern cold water region.

**How to identify:** The organic threads extruded from the processes scattered on the valve surface, connecting the cells in chains, are usually destroyed by fixation and preservation. *Porosira* spp. are therefore mainly present as single cells in preserved samples. The larger specimens may be misidentified as *Coscinodiscus* spp. when observed in girdle view in water mounts. In valve view in water mounts, *Porosira* spp. are recognized by the numerous strutted processes, seen as dark spots. The large labiate process is also usually discernible, especially if the numerous small chloroplasts are destroyed. Processes and areolation are easily discernible on permanent mounts with LM.

### Genus *Skeletonema* Greville 1865 (Plate 3, Table 6)

Type: *Skeletonema barbadense* Greville.

References: Greville, 1866, p. 77, Plate 8, Figs. 3–6; Cleve, 1873a, p. 7; Cleve, 1900a, p. 22, Plate 8, Figs. 30 and 31; Cleve-Euler, 1912, p. 509,

---

Scale bar = 1  $\mu\text{m}$ . *Skeletonema costatum*: (a) chain in girdle view, uppermost cell with two chloroplasts (note that the linking structures may be much shorter and less distinct); (b) intercalary valve with labiate process in the ring of marginal strutted processes; (c) separation valve (terminal/end valve) with labiate process close to valve center. *Skeletonema menzelleri*: (a) chain in girdle view; (b) valve with long, thin external parts of strutted processes and labiate process close to the valve center. Scale bars = 10  $\mu\text{m}$  except detail in *P. pentaportula*.



TABLE 6 Morphometric Data of *Skeletonema* spp.

Species	Pervalvar axis (µm)	Diameter (µm)	Marginal processes
<i>S. costatum</i>	2-61	2-21	6-30 (Total)
<i>S. menzelii</i>	3-10 <sup>a</sup>	2.7-7	5-10 (Total) <sup>a</sup>
<i>S. subsalsum</i>	7.5-17.5	3-6	10 in 10 µm
<i>S. tropicum</i>	10	4.5-38	7-9 in 10 µm

<sup>a</sup> Unpublished observations (Australian clone E.E.S.).

Fig. 1; Bethge, 1928, p. 343, Plate 11, Figs. 1-12; Hustedt, 1930, p. 310, Fig. 149; Cupp, 1943, p. 43, Fig. 6; Hendey, 1964, p. 91, Plate 7, Fig. 3; Hasle, 1973b; Round, 1973; Guillard et al., 1974; Hasle & Evensen, 1975; Takano, 1981, p. 46, Figs. 1-3; Medlin et al., 1991.

*Skeletonema barbadense* has been transferred to a new genus *Skeletonemopsis* P. A. Sims and a proposal is being made that *Skeletonemia costatum* should be conserved as the type of *Skeletonemia*, by replacing *S. barbadense* (Sims, 1994).

Generic characters:

- Cells in chains united by external tubes of strutted processes (complete or split longitudinally) arranged in one marginal ring.
- One labiate process inside the ring of strutted processes or close to valve center.
- Valve structure (barely seen with LM): radial areolation, central annulus more or less developed.

KEY TO SPECIES

- 1a. Many chloroplasts per cell, diameter usually greater than 20 µm . . . . . *S. tropicum* Cleve
- 1b. One or two chloroplasts per cell, diameter smaller . . . . . 2
- 2a. External tubes of marginal strutted processes threadlike . . . . . *S. menzelii* Guillard, Carpenter, & Reimann
- 2b. External tubes of marginal strutted processes more robust . . . . . 3
- 3a. External tubes of marginal strutted processes not split longitudinally, usually extremely short . . . . . *S. subsalsum*<sup>4</sup> (A. Cleve) Bethge
- 3b. External tubes of marginal strutted processes trough shaped with a wide longitudinal slit facing the valve margin . . *S. costatum*<sup>4</sup> (Greville) Cleve

<sup>4</sup> Basionyms: *Melosira subsalsa* A. Cleve and *Melosira costata* Greville, respectively.

**Distribution:**

*S. costatum*—cosmopolitan (absent from the high Arctic and Antarctic).

*S. tropicum*—warm water region.

*S. subsalsum*—brackish water.

*S. menzelii*—probably warm water region.

**How to identify:** Due to the unique appearance of the external tubes of the marginal strutted processes and of the colonies *Skeletonema* spp. will scarcely be confused with any other diatoms as long as typical chains or sibling valves are observed. However, a slight similarity between *Stephanopyxis turris* and large, coarsely silicified specimens of *Skeletonema costatum* and *S. tropicum* does exist. The linking structures of *S. costatum*, especially of cultured specimens, may be extremely short. In such cases, single cells may easily be misidentified as small *Thalassiosira* spp. In the same way, single valves, especially terminal valves with a central labiate process, may easily be confused with *Thalassiosira* spp. even when seen with EM. Whereas *S. costatum* and *S. tropicum* are differentiated on characters seen with LM, and the poorly known *S. menzelii* is distinguished with LM by the generally weak silicification and the thin connecting structures, SEM may be necessary to recognize the tubular connecting structures of *S. subsalsum*. *Skeletonema costatum* as presented here includes *S. pseudocostatum* Medlin in Medlin et al. (1991). With LM *S. pseudocostatum* has the appearance of an extremely small *S. costatum* (diameter 2–4  $\mu\text{m}$ ). *Skeletonema costatum* forms inseparable colonies, i.e., the external tubes of the marginal strutted processes of sibling valves are permanently attached also when organic material is removed by acid cleaning. *Skeletonema pseudocostatum* occurs in separable colonies, i.e., permanent attachments are absent. As a consequence of this difference *S. pseudocostatum* may in general appear in shorter chains than *S. costatum*. As shown by Medlin et al. (1991, Figs. 1–4), the distinction between the two species, i.e., the presence or absence of permanent attachment, is discernible with LM.

**Remarks:** The length of the linking structures (external tubes of strutted processes) of *S. subsalsum* varies with salinity (Hasle & Evensen, 1975; Paasche et al., 1975). The presence of resting spores/resting cells in *Skeletonema costatum* is still disputed.

**Genus** *Thalassiosira* Cleve 1873 emend. Hasle 1973

**Type:** *Thalassiosira nordenskiöldii* Cleve.

*Thalassiosira*, with its more than 100 species, is probably the marine planktonic genus most thoroughly examined by modern methods. Regional investigations, some of them including descriptions of new species, have been published in a high number since the first transmission electron microscopy (TEM) examinations started to appear in the 1950s (Helmcke & Krieger, 1953, 1954) and the first examinations taking with SEM in the 1960s (Hasle, 1968a). Attempts have been made to impose structure on this genus which seems to

increase in number of species parallel to the number of localities investigated. Location of labiate process linked with the presence or absence of external process tubes seemed for some time to be a promising distinctive character (Hasle, 1968a), and may still be, although several exceptions do exist. Makarova (1988) grouped 53 *Thalassiosira* species into the sections *Tangentales*, *Fasciculigera*, *Thalassiosira*, and *Inconspicuae* with keys to species for each section. Rivera (1981), Johansen & Fryxell (1985), Fryxell & Johansen (1990), and Hasle & Syvertsen (1990a) also constructed keys to species, none of them starting with the same morphological characters.

Generic characters:

Chains or cells embedded in mucilage.

Cells in chains connected by organic thread(s) extruded from strutted process(es).

Cells usually discoid.

Valve wall with loculate areolae in various patterns or with faint radial ribs.

Characters (LM) showing differences between species:

Girdle view—water mounts

Curvature/undulation of valve face.

Shape and height of valve mantle.

Connecting thread(s)—Length, thickness (indicating number of central strutted processes).

Threads extruded from the margin of valve face and/or mantle (indicating location and number of marginal rings of processes).

Length (and shape) of external part of processes.

The presence or absence of occluded processes.

Valve view—mostly cleaned, mounted valves

Length and location (external/internal) of process tubes.

Number and arrangement of strutted processes in or near valve center (see Central processes, *Remarks*, pg. 32).

The presence or absence of strutted processes on the rest of the valve face.

Number of marginal rings of strutted processes.

Distance between marginal strutted processes (number in 10  $\mu\text{m}$ ).

Distance of marginal strutted processes from margin (number of areolae).

Number and location of labiate process(es).

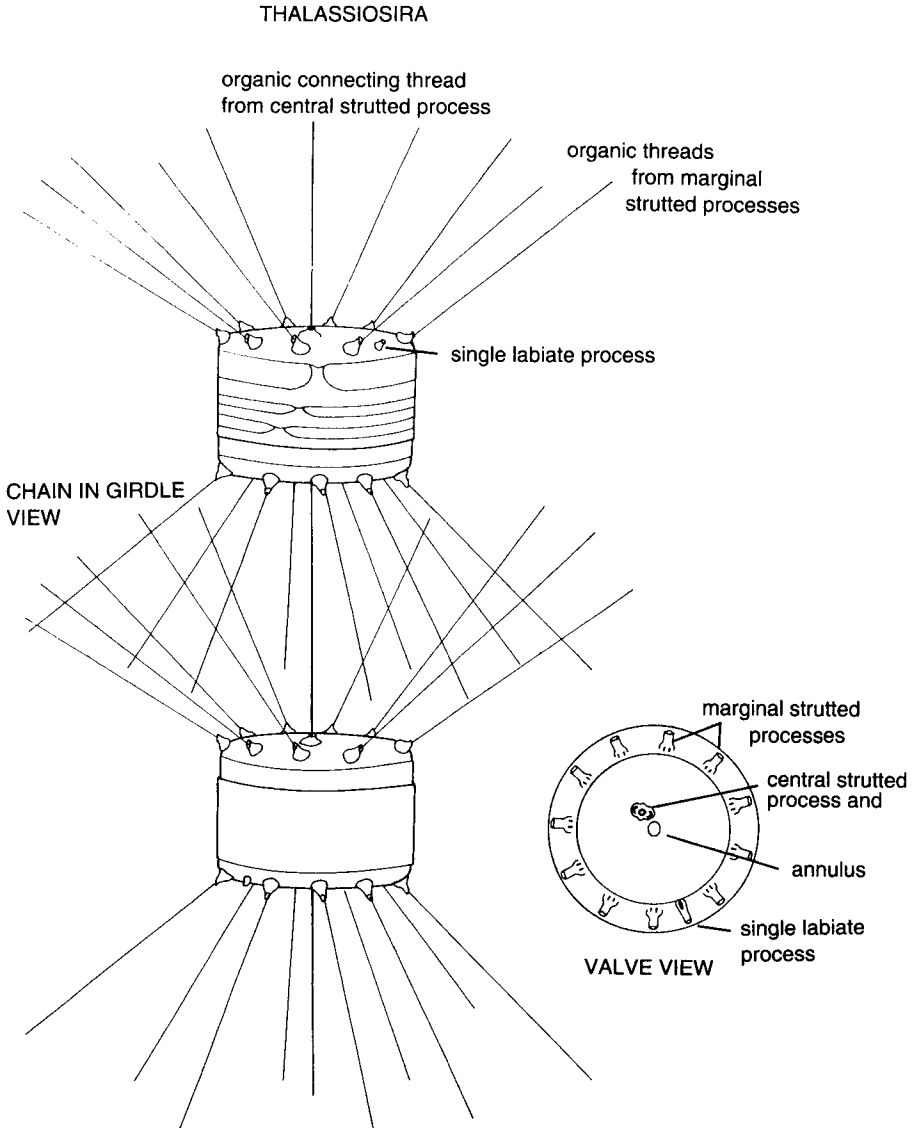

FIGURE 11 Schematic illustrations of chain formation and processes in *Thalassiosira*.

Areolae size and array.

Occurrence of occluded processes.

The presence of a central areola or an annulus.

The presence of marginal ribs.

**How to identify:** For the sake of completeness the shape of the girdle view is included in the description of the single species. It should be kept in mind that the ratio between peralvar axis and diameter often varies considerably within the single species, and that the cell diameter varies considerably within the single species as illustrated by a clonal culture of *T. punctigera* (Fig. 12). Information on length of peralvar axis is lacking for many of the *Thalassiosira* species. The terms box shaped, cylindrical, drum shaped, discoid, and coin shaped are in frequent use in the literature to describe the shape of *Thalassiosira* spp. in girdle view. Diatoms in general are box shaped, and the term can thus hardly be regarded as distinctive. Cylindrical, however, as used for “any body having length, a constant diameter, and ends parallel to each other,” appears as a convenient descriptive term for diatoms with a peralvar axis of a certain length but with no reference to the shape of the valves except for the circular outline. Drum shaped may be interpreted as cylindrical cells with flattened valves, and discoid and coin shaped indicate cells with comparatively short peralvar axis and circular, flattened valves. Only a few *Thalassiosira* species can be identified when seen in girdle view. Positive identification with LM has to rely, for most of the species, on examination of valves cleaned of organic matter and mounted in a medium of a high refractive index. In this chapter the *Thalassiosira* species have been grouped according to process patterns, i.e., location of labiate process(es), number and arrangement of central/ subcentral strutted process(es), and number of marginal rings of strutted processes. The objection may be raised that the structure of strutted and labiate processes cannot be distinguished with LM. Although this may be true for many *Thalassiosira* species, a trained light microscopist can learn to distinguish them by shape and size. Occluded processes are usually readily recognized in water mounts, particularly on cells in girdle view (Fig. 12), and in special cases the labiate process as well as the strutted processes are distinguished in water mounts as soon as the cell loses the chloroplasts (Fig. 12; see Plate 5 for comparison).

- A. Labiate process(es) near valve mantle; external tubes usually present.
  1. One central or subcentral strutted process.
    - a. One marginal ring of strutted processes: *T. aestivalis*, *T. allenii*, *T. angulata*, *T. binata*, *T. bulbosa*, *T. conferta*, *T. decipiens*, *T. ferelineata*, *T. hispida*, *T. licea*, *T. mala*, *T. minuscula*, *T. nordenskiöldii*, *T. oceanica*, *T. pacifica*, *T. partheneia*, *T. punctigera*, *T. subtilis*, and *T. tenera* (Table 7).

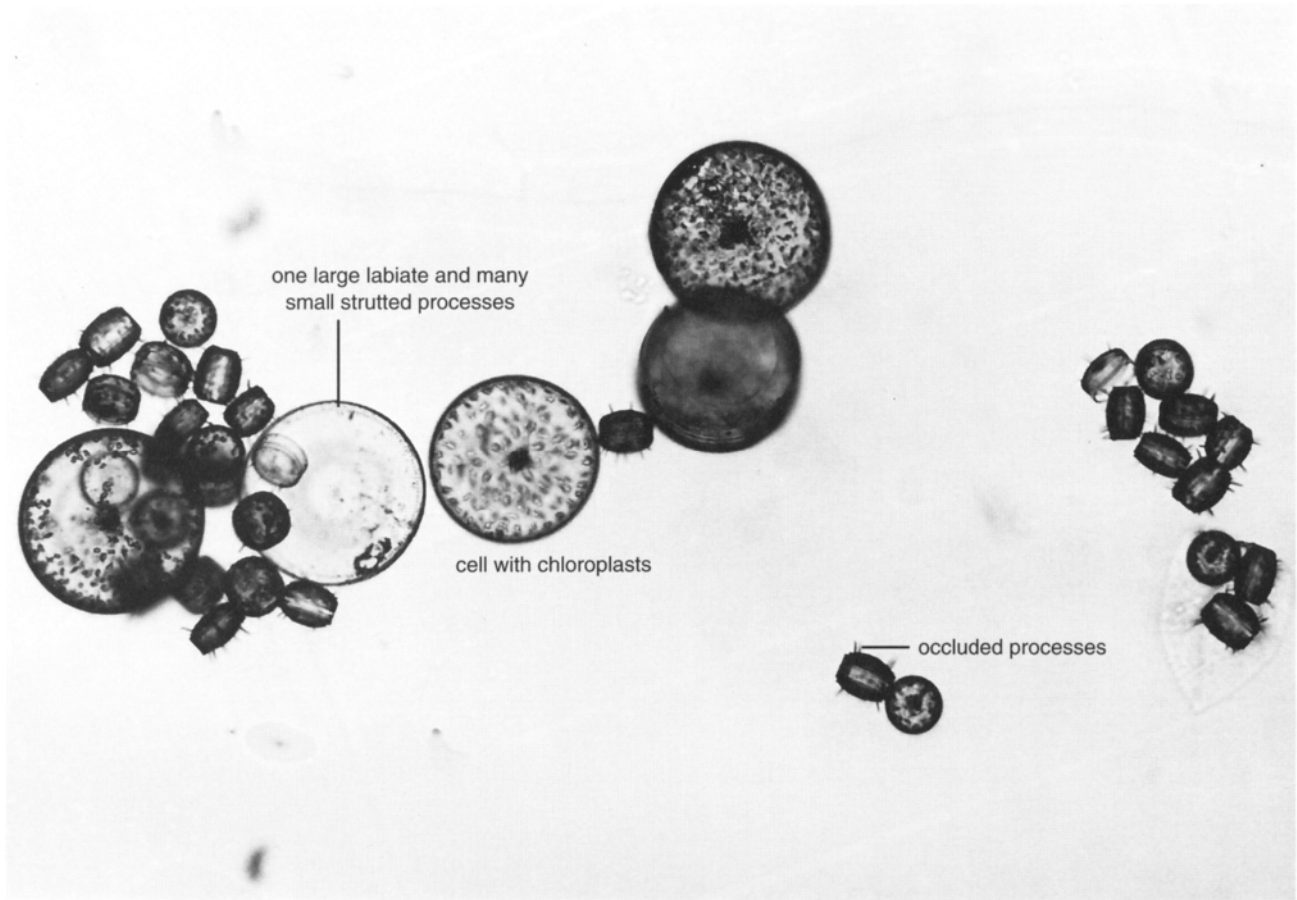

FIGURE 12 A light micrograph of a clonal culture of *Thalassiosira punctigera* shortly after auxospore formation, showing the size variation.

- b. More than one marginal ring of strutted processes: *T. delicatula*, *T. diporocyclus*, *T. eccentrica*, *T. fragilis*, *T. hendeyi*, *T. mendiolana*, and *T. simonsenii* (Table 8).
  - 2. Usually more than one central or subcentral strutted process.
    - a. One or a few (2–6) subcentral strutted processes: *T. curviseriata*, *T. dichotomica*, *T. minima*, and *T. tealata* (Table 9).
    - b. Cluster of central strutted processes: *T. antarctica*, *T. baltica*, *T. constricta*, *T. gerloffii*, *T. gravida*, *T. hyalina*, *T. karenae*, *T. rotula*, and *T. tumida* (Table 10).
    - c. Modified ring of subcentral strutted processes: *T. anguste-lineata*, *T. australis*, *T. hyperborea*, *T. kushirensis*, *T. mediterranea*, and *T. weissflogii* (Table 11).
  - 3. No or a variable number of strutted processes on valve face.
    - a. No strutted processes on valve face: *T. leptopus* (Table 12).
    - b. Zero to three subcentral strutted processes: *T. guillardii* and *T. pseudonana* (Table 12).
    - c. No particular central or subcentral strutted process: *T. lentiginosa*, *T. lineata*, and *T. lineoides* (Table 13).
- B. Labiate process on valve face; external process tubes absent, one ring of marginal strutted processes.
  - 1. One central or subcentral strutted process: *T. bioculata*, *T. gracilis*, *T. oestrupii*, *T. perpussilla*, *T. proschkinae*, and *T. rosulata* (Table 14).
  - 2. More than one central strutted process.
    - a. Cluster of central strutted processes: *T. ritscheri* (Table 15).
    - b. One or two rows of central/subcentral strutted processes: *T. confusa*, *T. frenguelli*, *T. poroseriata*, and *T. trifulta* (Table 15).
    - c. Modified ring of subcentral strutted processes: *T. endoseriata* and *T. poro-irregulata* (Table 15).
- A. Labiate process(es) near valve mantle.
  - 1a. One central or subcentral strutted process. One marginal ring of strutted processes.

This is the most numerous *Thalassiosira* group containing species that are the most difficult to distinguish. Except for the few species with an invariable *lineatus* structure (areolae in straight tangential rows), the areolation pattern varies with the size of the cell diameter from straight or tangential rows in the

smaller specimens to distinct fasciculation in the larger ones, or from radial rows to fasciculation. Depending on the degree of silicification the valve structure of one and the same species may vary from merely faint radial ribs to a fully developed areolation.

*Thalassiosira allenii* Takano (Plate 4, Table 7)

**References:** Takano, 1965, p. 4, Fig. 2, Plate 1, Figs. 9–11; Hasle, 1978a, p. 101, Figs. 100–128; Rivera, 1981, Figs. 432 and 433; Takano, 1990, pp. 180–181.

**Girdle view:** Cells quadrangular; valve face flat; valve mantle oblique. Connecting thread slightly longer than perivalvar axis.

**Valve view:** Hexagonal areolae in straight or curved tangential rows, or in radial rows with a tendency of fasciculation; no distinct central areola; mantle areolae about half the size of those on valve face. Labiate process taking the place of a marginal strutted process; long, coarse external tubes of marginal processes.

**Distinctive features:** Similar to *T. nordenskiöldii* in girdle view but with lower mantle, marginal processes closer together, and much smaller mantle areolae.

*Thalassiosira angulata* (Gregory) Hasle (Plate 4, Table 7)

**Basionym:** *Orthosira angulata* Gregory.

**Synonym:** *Thalassiosira decipiens* (Grunow) Jørgensen *non* *Thalassiosira decipiens* (Grunow) Jørgensen in Hasle 1979.

**References:** Gregory, 1857, p. 498, Plate 10, Figs. 43 and 43b; Jørgensen, 1905, p. 96 *pro parte*, Plate 5, Fig. 3a–e; Hustedt, 1930, p. 322, Fig. 158; Cupp, 1943, p. 48, Fig. 10, in both as *Thalassiosira decipiens* (Grunow) Jørgensen; Hasle, 1978a, p. 93, Figs. 4 and 70–99; Rivera, 1981, Fig. 436; Makarova, 1988, p. 56, Plate 27, Figs. 1–4 and 7–10.

**Girdle view:** Perivalvar axis usually shorter than the diameter. Valve face flat; mantle smoothly curved. Connecting thread distinctly longer than perivalvar axis. External tubes of marginal processes usually readily seen.

**Valve view:** Hexagonal areolae in curved tangential rows (eccentric structure), sometimes in straight rows or in sectors; no distinct central areola. Marginal processes with long external tubes; wide apart.

**Distinctive features:** Large labiate process with long external tube located close to a marginal strutted process; sharp distinction between valve mantle and valvocopula.

**Remarks:** *Thalassiosira decipiens* (Grunow) Jørgensen differs morphologically from *T. angulata* by more closely spaced marginal processes and a lower valve mantle. *Thalassiosira decipiens* is unlike *T. angulata*, littoral more than planktonic, and is found in great inland seas, estuaries, bays, shallow coastal waters, and rivers influenced by the tide (Hasle, 1979).



Thalassiosira*T. allenii**T. angulata**T. bulbosa**T. conferta*

PLATE 4 *Thalassiosira allenii*, *T. angulata*, *T. bulbosa*, and *T. conferta*. (a) Chains in girdle view; (b) valves with process pattern. Scale bars = 10  $\mu\text{m}$ .

TABLE 7 Morphometric Data of *Thalassiosira* spp. with One Central or Subcentral Struttred Process and One Marginal Ring of Struttred Processes

Species	Diameter ( $\mu\text{m}$ )	Valve face	Areolae in 10 $\mu\text{m}$	
			Valve mantle	Marginal
<i>T. aestivalis</i> <sup>a</sup>	14–56	18	>20	4
<i>T. allenii</i>	5–20	18–24	30–40	6
<i>T. angulata</i>	12–39	8–18	14–24	3
<i>T. binata</i> *	4–18	30–40	30–40	5–13 Total
<i>T. bulbosa</i> , veg. Rest. cells	2–16	36–42 20–26	36–42 20–26	ca. 4.5 — <sup>b</sup>
<i>T. conferta</i>	3.5–23	25–27	25–27	3–5 $\mu\text{m}$ apart
<i>T. decipiens</i> <sup>a</sup>	9–40	8–12	10–15	4–6
<i>T. ferelineata</i> <sup>a</sup>	20–43	6–7	6–7	3–4
<i>T. hispida</i> <sup>a</sup>	15–25	18	24–26	5
<i>T. liceae</i> <sup>a</sup>	16–36	11–12	14–15	2
<i>T. mala</i>	4–10	25–30	ca. 50	4–10
<i>T. minuscula</i>	10–27	32–48	32–48	3–4 $\mu\text{m}$ apart
<i>T. nordenskiöldii</i>	10–50	14–18	14–18	3
<i>T. oceanica</i>	3–12	40–60	40–60	3–4
<i>T. pacifica</i>	7–46	10–19	20–28	4–7
<i>T. partheneia</i>	6–14	40–60	40–60	3–5
<i>T. punctigera</i>	40–186	10–23	10–23	4–5 (Mostly)
<i>T. subtilis</i>	15–32	ca. 30	ca. 30	ca. 3–4 $\mu\text{m}$ apart
<i>T. tenera</i>	10–29	10–16	10–16	3–5

<sup>a</sup> Mentioned in the text for comparison.

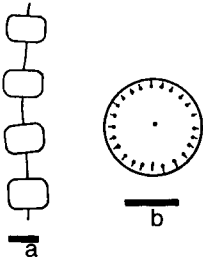
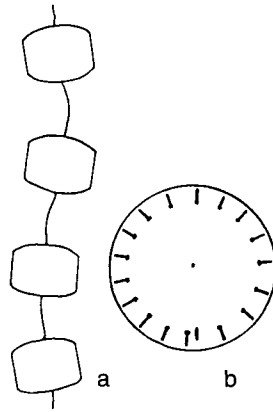
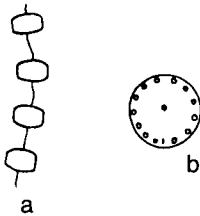
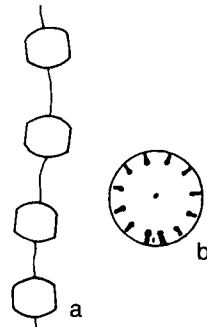
<sup>b</sup> —, No data.

### *Thalassiosira bulbosa* Syvertsen (Plate 4, Table 7)

Reference: Syvertsen & Hasle, 1984.

**Girdle view:** Cells discoid; valve face slightly convex or flat; valve mantle rounded. Solitary or less frequently in short chains with connecting thread slightly longer than perivalvar axis.

**Valve view:** Dimorphic, lightly silicified vegetative cells and heavily silicified resting cells or semiendogenous resting spores. The valve areolation of the latter two just visible with LM. Central struttred process close to a prominent annulus. Labiate process between two marginal struttred processes, the latter with low bulb-shaped outer parts.

**Distinctive feature:** Shape of marginal struttred processes.

***Thalassiosira conferta* Hasle (Plate 4, Table 7)**

**References:** Hasle & Fryxell, 1977a, p. 239, Figs. 1–23; Makarova et al., 1979, p. 922, Plate 1, Figs. 8 and 9; Rivera, 1981, p. 50, Figs. 48–62; Takano, 1990, pp. 190–191.

**Girdle view:** Cells octagonal; valve mantle highly vaulted. Pervalvar axis from less than to twice the cell diameter. Long external tubes of marginal processes, two of them longer and thicker than the others and extruding longer and thicker threads.

**Valve view:** Valve areolae in radial rows, in sectors in larger specimens, central areola or annulus more or less prominent. Labiate process extremely small, located between the two larger marginal strutted processes.

**Distinctive features:** Size and location of labiate process and adjacent strutted processes.

***Thalassiosira mala* Takano (Plate 13, Table 7)**

**References:** Takano, 1965, p. 1, Fig. 1, Plate 1, Figs. 1–8; Takano, 1976; Hasle, 1976a, Figs. 42 and 43; Hallegraeff, 1984, p. 497, Fig. 2; Takano, 1990, pp. 210–211.

**Girdle view:** Cells discoid; valve face flat; mantle low and rounded, and embedded in cloud-like gelatinous masses of various shapes.

**Valve view:** Areolation visible with LM by focusing on central part of valve face. Central strutted process off center; marginal strutted processes with inconspicuous external tubes, labiate process midway between two of them.

**Distinctive features:** In water mounts the mucilage colonies appear cloudlike. On cleaned, mounted valves the location of the central process and the coarsely structured central part of valve face.

**Remarks:** *Thalassiosira mala* is one of the first or probably the first marine planktonic diatom to be reported as being harmful to shellfish. A bloom of this species discoloring the water of Tokyo Bay in September 1951 was considered responsible for damages amounting to 57,958,000 Yen (Takano, 1956). “Mechanical closing of the respiration by a gelatinous substance densely attached to the gills” (Takano, 1956, p. 65) exuded from the diatom, together with poor quality water, was regarded as responsible for the death of the bivalves.

***Thalassiosira minuscula* Krasske (Plate 5, Table 7)**

**Synonym:** *Thalassiosira monoprocyclus* Hasle.

**References:** Krasske, 1941, p. 262, Plate 5, Figs. 4–6; Hasle, 1972a, p. 129, Figs. 46–60; Hasle, 1976b, p. 104, Figs. 6–10; Rivera, 1981, p. 95, Figs. 246–262.

**Girdle view:** Pervalvar axis equal to or shorter than valve diameter, valve surface evenly curved. One or more cells surrounded by capsules and embedded in mucilage to form colonies of various shape and size.

*Thalassiosira*

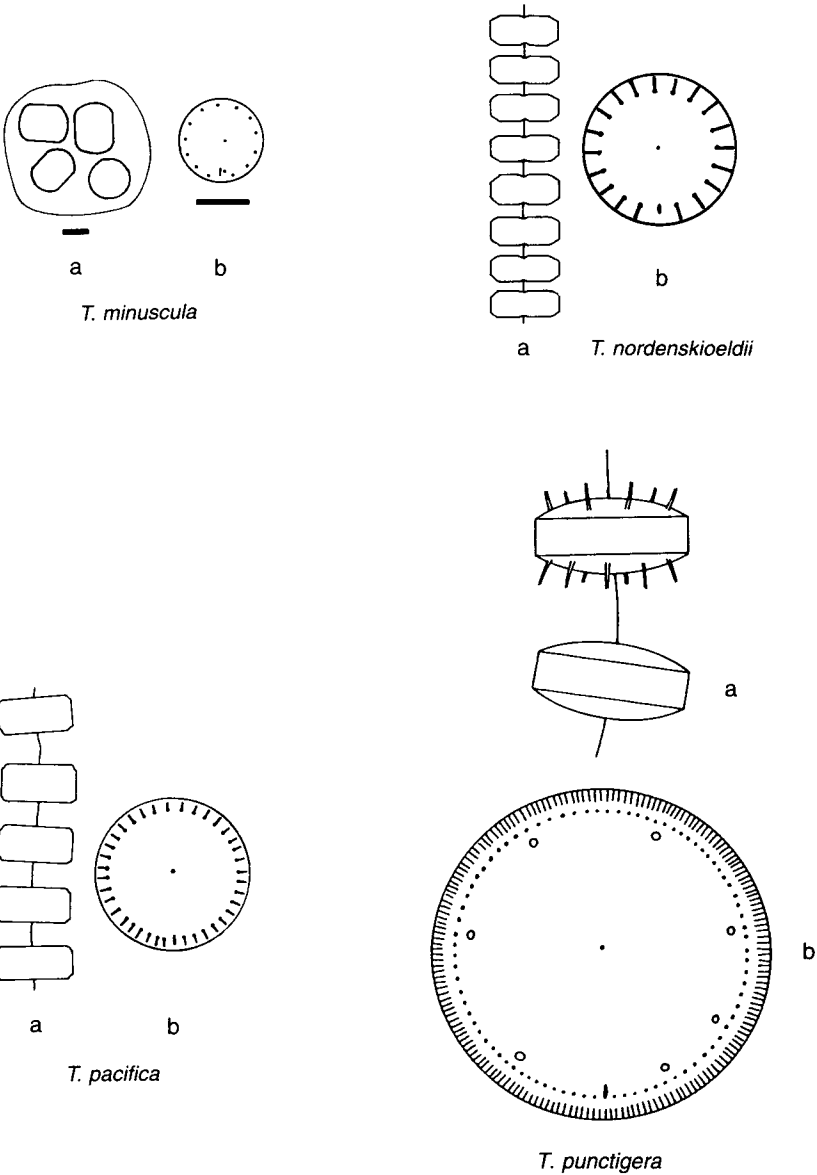

PLATE 5 *Thalassiosira minuscula*: (a) mucilage colony of four cells, three in girdle and one in valve view; valve with processes, labiate process with adjacent strutted process. *Thalassiosira nordenskiöldii*: (a) chain in girdle view; (b) valve view showing processes. From Hasle & Syvertsen (1990a). *Thalassiosira pacifica*: (a) chain in girdle view; (b) valve with process pattern. *Thalassiosira punctigera*: (a) chain in girdle view with evident occluded processes on one cell; (b) valve with marginal ribs, ring of close set strutted processes, and occluded processes (open rings). Scale bars = 10  $\mu\text{m}$ .

**Valve view:** Areolation barely visible with LM. Strutted and labiate processes lacking external tubes (SEM), labiate process close to one or two strutted processes located at some distance from valve margin.

**Distinctive features:** In water mounts cells in colonies inside capsules. On cleaned, mounted valves the location of the labiate process and the associated strutted process(es).

**Remarks:** Due to the lack of external process tubes and the location of the labiate process at some distance from the valve margin *T. minuscula* could just as well be placed into group B as in group A. Unlike species of group B, *T. minuscula* has short internal tubes, a feature shared with *T. subtilis*, *T. diporocyclus*, and *T. fragilis*, all appearing in mucilage colonies (Hasle, 1972a; Fryxell et al., 1984)

*Thalassiosira nordenskiöldii* Cleve (Plate 5, Table 7)

**References:** Cleve, 1873b, p. 7, Plate 1, Fig. 1; Hustedt, 1930, p. 321, Fig. 157; Cupp, 1943, p. 46, Fig. 8; Hendey, 1964, p. 85, Plate 1, Fig. 8; Hasle, 1978a, p. 79, Figs. 1 and 5–20; Syvertsen, 1979, p. 49, Figs. 6–14; Takano, 1990, pp. 214–215.

**Girdle view:** Cells octagonal, pronounced concavity around valve center; valve mantle high; oblique. Connecting thread as long as perivalvar axis or shorter. Long slender external tubes of marginal processes with bases on the distinct bend between valve face and mantle.

**Valve view:** Areolation delicate but discernible with LM, more so in resting spores (semiendogenous or endogenous) than in vegetative cells. Central strutted process close to central areola (annulus). Marginal processes prominent; location of labiate process variable within the ring of strutted processes.

**Distinctive features:** Shape of cell, especially the slanting valve mantle; long external tubes of processes.

**Remarks:** *Thalassiosira aestivalis* Gran, *T. binata* G. Fryxell, *T. hispida* Syvertsen and *T. conferta* are all more or less octagonal in girdle view. *Thalassiosira aestivalis* is distinguished from *T. nordenskiöldii* in girdle view by a lower mantle and usually a longer distance between cells in colonies, and in valve view mainly by the more closely spaced marginal processes (Hasle, 1978a). *Thalassiosira binata* is generally smaller with much finer areolation (Hasle & Fryxell, 1977a), and *T. conferta* is distinguished by the small labiate and the adjacent long strutted processes. *Thalassiosira hispida* is generally smaller than *T. nordenskiöldii*, with smaller mantle areolae than on valve face, and as conspicuous with EM, “knobs and hairs on valve surface” (Syvertsen, 1986, Table 1).

*Thalassiosira oceanica* Hasle (Plate 13, Table 7)

**Synonym:** *Cyclotella nana* Guillard clone 13-1 in Guillard & Ryther.

**References:** Guillard & Ryther, 1962, Plate 1, Fig. 1D; Hasle, 1983a, p. 220, Figs. 1–18.

**Girdle view:** Cells rectangular; perivalvar axis somewhat shorter than diameter.

**Valve view:** Valve structure (radial ribs or poroid areolae, EM) not resolved with LM. Processes distinct; marginal processes with short external tubes located close to valve margin; labiate process close to one strutted process.

**Distinctive features:** On cleaned mounted valves the widely spaced marginal processes and the location of labiate process.

**Remarks:** An undulated marginal ridge, spinules and sometimes a finely perforated top layer covering the radial ribs are revealed with EM (Plate 13; Hasle, 1983a; Hallegraeff, 1984).

*Thalassiosira pacifica* Gran & Angst (Plate 5, Table 7)

**References:** Gran & Angst, 1931, p. 437, Fig. 12; Hasle, 1978a, p. 88, Figs. 42–69; Rivera, 1981, p. 105, Figs. 281–307; Makarova, 1988, p. 57, Plate 28, Figs. 1–9; Takano, 1990, pp. 218–219.

**Girdle view:** Cells rectangular with rounded low mantle; valve face flat or slightly concave. Connecting thread about as long as the perivalvar axis.

**Valve view:** Loculate areolae in linear, eccentric or fasciculate patterns depending on the diameter of the cell. Central process adjacent to a central areola (annulus), marginal strutted processes with distinct coarse external tubes, labiate process positioned as for a marginal strutted process.

**Distinctive features:** Mantle areolae smaller than those on valve face, valve margin ribbed. Distinguished from *T. angulata* by the ribbed margin; the more closely spaced marginal processes with shorter external tubes and the location of the labiate process.

*Thalassiosira partheneia* Schrader (Table 7)

**References:** Schrader, 1972; Hasle, 1983a, p. 223, Figs. 19–36; Fryxell et al., 1984, p. 143, Figs. 2–16.

**Girdle view:** Perivalvar axis equal to or larger than cell diameter; valve evenly curved; occurring in large gelatinous masses containing numerous threads extruded from strutted processes.

**Valve view:** Valve structure (radial ribs or poroid areolae in radial rows, EM) not revealed with LM. Processes distinct; internal parts longer than inconspicuous external parts; labiate process almost equidistant between two strutted processes.

**Distinctive features:** In water mounts the colonies with cells are entangled in threads. On cleaned mounted valves the shape of the strutted processes and the location of labiate process (as distinct from *Thalassiosira oceanica*).

*Thalassiosira punctigera* (Castracane) Hasle (Figs. 6f and 6g and 12, Plate 5, Table 7)

**Basionym:** *Ethmodiscus punctiger* Castracane.

**Synonym:** *Thalassiosira angstii* (Gran) Makarova; for further synonymy see Hasle, 1983b, p. 602.

**References:** Castracane, 1886, p. 167, Plate 3, Fig. 1; Makarova, 1970, p. 13; Fryxell, 1978a, p. 133, Figs. 9–20; Hasle, 1983b; Makarova, 1988, p. 67, Plate 38, Figs. 1–10; Takano, 1990, pp. 224–225.

**Girdle view:** Cells low cylindrical; valve surface convex, evenly curved, usually with long tubes (occluded processes). Connecting thread thin.

**Valve view:** Areolation fasciculate, valve margin ribbed. Small, densely spaced strutted processes with short external tubes close to valve margin; larger widely spaced occluded processes more away from valve margin.

**Distinctive features:** Occluded processes; structure of valve margin.

**Remarks:** *Thalassiosira punctigera* is recognized by the ribbed margin and the presence of occluded processes. *Thalassiosira licea* G. Fryxell and *T. lundiana* G. Fryxell are closely related to *T. punctigera*; *T. licea* has more widely spaced marginal strutted processes, and *T. lundiana* has strutted processes scattered on the valve face in two marginal rings and a finer areolation (Fryxell, 1978a). Occluded processes may or may not be present in the three species.

*Thalassiosira subtilis* (Ostenfeld) Gran (Table 7)

**Basionym:** *Podosira* (?) *subtilis* Ostenfeld.

**References:** Ostenfeld, 1899, p. 55; Ostenfeld, 1900, p. 54; Gran, 1900, p. 117; Ostenfeld, 1903, p. 563, Fig. 119; Hasle, 1972a, p. 112, Figs. 1–20; Rivera, 1981, p. 123, Figs. 359–377.

**Girdle view:** Pervalvar axis and diameter of about the same size, valve surface curved; marginal zone usually more than valve center. Embedded in mucilage without any particular order.

**Valve view:** Areolation fasciculate; areola rows parallel to central row. Strutted processes scattered on valve face (between one subcentral process and one marginal ring of processes). Strutted and labiate processes lacking external tubes (SEM). Labiate process located at some distance from valve margin.

**Distinctive features:** On cleaned mounted valves, the scattered strutted processes and the labiate process are from valve margin. See remarks to *T. minuscula*.

**Remarks:** *Thalassiosira subtilis* was the first species of this genus to be described as being embedded in mucilage (Ostenfeld, 1899, p. 55). Other, more recently described species occurring in this type of colony (Hasle, 1972a; Fryxell et al., 1984) may therefore have been misidentified as *T. subtilis*.

***Thalassiosira tenera*** Proschkina-Lavrenko (Table 7)

**References:** Proschkina-Lavrenko, 1961, p. 33, Plate 1, Figs. 1–4, Plate 2, Figs. 5–7; Hasle & Fryxell, 1977b, p. 28, Figs. 54–65; Takano, 1990, pp. 232–233.

**Girdle view:** Cells rectangular; valve face and mantle forming an almost right angle; perivalvar axis about the same length or longer than cell diameter. Chloroplasts 5–9.

**Valve view:** Hexagonal areolae in straight tangential rows (lineatus structure); a slightly larger central areola (encompassing the central strutted process, SEM). External parts of marginal strutted processes wedge shaped.

**Distinctive features:** The linear areola array and the shape of marginal strutted processes.

**Remarks:** *Thalassiosira ferelineata* Hasle & Fryxell is slightly larger and coarser in structure but with the same areola array and process pattern as *T. tenera* (Hasle & Fryxell, 1977b). The main difference is the lack of external process tubes in *T. ferelineata*.

**Distribution:**

*T. bulbosa*—northern cold water region.

*T. hispida* and *T. nordenskiöldii*—northern cold water region to temperate.

*T. ferelineata*, *T. licea*, *T. oceanica*, and *T. partheneia*—mainly warm water region.

*T. aestivalis*, *T. allenii*, *T. binata*, *T. mala*, *T. minuscula*, *T. punctigera*, and *T. subtilis*—warm water region to temperate?

*T. conferta*, *T. pacifica*, and *T. tenera*—cosmopolitan, exclusive polar regions.

*T. angulata*—North Atlantic Ocean (see Hasle, 1978a). It should be noted that *T. hibernalis* Gayoso, described from Argentina, is morphologically very close to *T. angulata*.

1b. One central or subcentral strutted process. More than one marginal ring of strutted processes.

***Thalassiosira delicatula*** Ostensfeld in Borgert, 1908 (Plate 6, Table 8), *non Thalassiosira delicatula* Hustedt.

**Synonym:** *Thalassiosira coronata* Gaarder.

**References:** Borgert, 1908, p. 16, Figs. A and B; Gaarder, 1951, p. 30, Fig. 17; Hasle, 1980, p. 170, Figs. 18–34; Rivera, 1981, p. 53, Figs. 63–107.

**Girdle view:** Perivalvar axis as long as or longer than cell diameter; valve face with a central cavity; valve mantle high and smoothly rounded.

Connecting thread thin and as long as the perivalvar axis. Single cells or



*Thalassiosira*

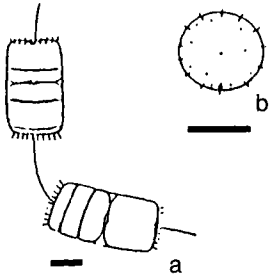

*T. delicatula*

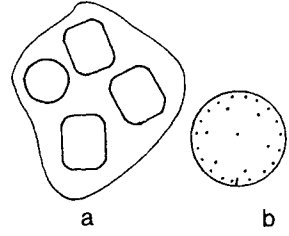

*T. diporocylus*

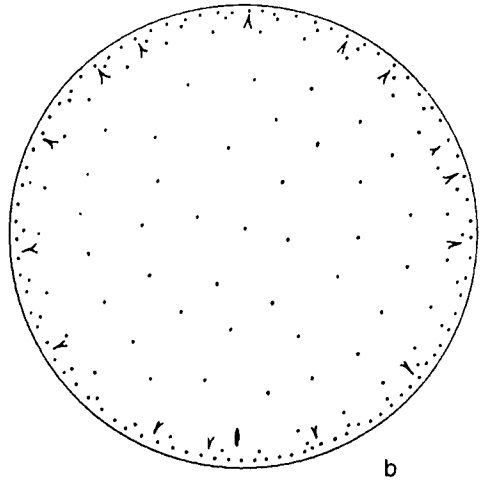
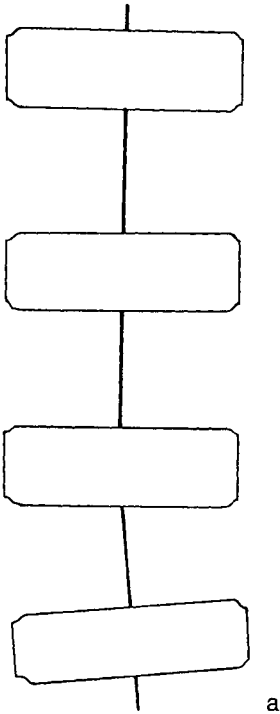

*T. eccentrica*

TABLE 8 Morphometric Data of *Thalassiosira* spp. with One Central or Subcentral Struttred Process and More Than One Marginal Ring of Struttred Processes

Species	Diameter ( $\mu\text{m}$ )	Valve areolae in 10 $\mu\text{m}$	Marginal proc. in 10 $\mu\text{m}$
<i>T. delicatula</i>	9–30	22–26	4–5
<i>T. diporocyclus</i>	12–24	24–31	2.7–3.8 $\mu\text{m}$ apart
<i>T. eccentrica</i>	15–110	5–11	2–5
<i>T. fragilis</i> <sup>a</sup>	19–30.5	40–50	3–5 $\mu\text{m}$ apart
<i>T. hendeyi</i>	42–110	5–6	5–6
<i>T. mendiolana</i> <sup>a</sup>	26–45	11–17	6–8
<i>T. simonsenii</i>	30–59	4–5	5–6

<sup>a</sup> Mentioned in the text for comparison.

chains sometimes embedded in mucilage forming large colonies. Long tubular (occluded) processes.

**Valve view:** Areolae in radial rows with slight fasciculation in larger specimens. Struttred processes on valve alternating, located in three rings, scattered struttred processes on valve face of larger specimens; external parts of struttred processes conspicuous but much shorter than those of occluded processes located in a ring between valve face and mantle.

**Distinctive features:** High peralvar axis; occluded processes.

**Remarks:** Rivera (1981) put *T. chilensis* Krasske into synonymy with *T. delicatula* Ostenfeld.

*Thalassiosira diporocyclus* Hasle (Plate 6, Table 8)

**References:** Hasle, 1972a, p. 113, Figs. 25–45; Rivera, 1981, p. 60, Figs. 108–128; Takano, 1990, pp. 196–197.

**Girdle view:** Peralvar axis of about the same size as cell diameter; central part of valve flat; mantle extremely curved. Cells in irregular mucilage colonies containing vast numbers of threads from the cells.

**Valve view:** Areolation fasciculate. Two marginal rings of struttred processes lacking external tubes; the single labiate process in peripheral ring.

PLATE 6 *Thalassiosira delicatula*: (a) short chain; (b) valve with processes. From Gaarder (1951). *Thalassiosira diporocyclus*: (a) mucilage colony; (b) valve with processes. *Thalassiosira eccentrica*: (a) chain in girdle view; (b) valve with process pattern. Scale bars = 10  $\mu\text{m}$ .

**Distinctive features:** In water mounts, colonies formed by numerous distinct threads. On cleaned mounted material the two rings of processes with the labiate process in the peripheral ring.

**Remarks:** *Thalassiosira fragilis* G. Fryxell is similar to *T. diporocyclus* in valve morphology and colony formation but differs by having two labiate processes and the strutted processes, especially those in the inner ring, wider apart (Fryxell et al., 1984).

*Thalassiosira eccentrica* (Ehrenberg) Cleve (Plate 6, Table 8)

**Basionym:** *Coscinodiscus eccentricus* Ehrenberg.

**References:** Ehrenberg, 1841a, p. 146; Ehrenberg, 1843, Plate 1/3, Fig. 20, Plate 3/7, Fig. 5; Cleve, 1904, p. 216; Hustedt, 1930, p. 388, Fig. 201; Cupp, 1943, p. 52, Fig. 14; Fryxell & Hasle, 1972, p. 300, Figs. 1–18; Rivera, 1981, p. 64, Figs. 129–140; Makarova, 1988, p. 48, Plates 20 and 21; Takano, 1990, pp. 198–199.

**Girdle view:** Depending on cell diameter, perivalvar axis from one-sixth to longer than the length of the diameter. Valve face flat; mantle low and rounded. Connecting thread about twice the cell diameter.

**Valve view:** Areolae in curved tangential rows (eccentric structure) with a tendency of fasciculation. Central strutted process adjacent to a central areola surrounded by a ring of seven areolae; scattered strutted processes on valve face; two marginal rings of strutted processes with short external tubes; one ring of pointed spines further away from valve margin.

**Distinctive features:** Areola pattern of valve center; marginal spines.

**Remarks:** *Thalassiosira angulata* and *T. pacifica* with eccentric structure lack the central areola and process arrangement, the marginal spines and the processes scattered on the valve face. *Thalassiosira mendiolana* Hasle & Heimdal has the same process pattern as *T. eccentrica* but is usually more weakly silicified with smaller areolae arranged in sectors (Fryxell & Hasle, 1972).

*Thalassiosira hendeyi* Hasle & G. Fryxell (Table 8)

**Synonym:** *Coscinodiscus hustedtii* Müller-Melchers.

**References:** Müller-Melchers, 1953, p. 2, Plate 1, Figs. 2-5; Hasle & Fryxell, 1977b, p. 25, Figs. 35-45.

**Girdle view:** Perivalvar axis somewhat shorter than cell diameter.

Valvocopula coarsely structured. Low, wavy marginal ridge. Two labiate processes with long external tubes.

**Valve view:** Hexagonal areolae in straight tangential rows (lineatus structure). Small strutted processes in three marginal rings (not resolved with LM).

**Distinctive features:** External tubes of two labiate processes; lineatus type of areolation; marginal ridge.

***Thalassiosira simonsenii* Hasle & G. Fryxell (Table 8)**

Reference: Hasle & Fryxell, 1977b, p. 23, Figs. 26–34.

**Girdle view:** Cells discoid; mantle low and slanting.

**Valve view:** Hexagonal areolae in straight tangential rows (lineatus structure). Central strutted process adjacent to a small areola. Ribbed margin. Small strutted processes in two alternating marginal rings (not readily visible with LM); two labiate processes with long external tubes; occluded processes.

**Distinctive features:** Lineatus type of areolation, ribbed margin, occluded processes.

**Distribution**

*T. delicatula* and *T. eccentrica*—cosmopolitan, exclusive polar regions.

*T. diporocylus*, *T. fragilis*, *T. hendeyi* and *T. simonsenii*—warm-water region to temperate.

*T. mendiolana*—South Pacific Ocean only.

2a. One or a few (two to six) subcentral strutted processes.

***Thalassiosira curviseriata* Takano (Plate 7, Table 9)**

References: Takano, 1981, p. 34, Figs. 26–38; Hallegraeff, 1984, p. 498, Fig. 8; Takano, 1990, pp. 192–193.

**Girdle view:** Cells discoid; valve face with central concavity; mantle high and slanting. Connecting thread long. Cells also found embedded in mucilage to form large colonies. Several large disc-shaped chloroplasts.

**Valve view:** Areolation radial; just discernible with LM (cleaned, embedded material). One or probably more often, two strutted processes adjacent to a more or less off centered annulus. Marginal strutted processes conspicuous being equipped with two opposing wings; labiate process close to a marginal strutted process.

**Distinctive features:** Off-centered valve structure, winged marginal strutted processes.

**Remarks:** *Thalassiosira tealata* Takano has one central process and marginal processes with longer wings than those of *T. curviseriata* (Takano, 1980).

***Thalassiosira dichotomica* (Kozlova) G. Fryxell & Hasle (Table 9)**

**Basionym:** *Porosira dichotomica* Kozlova.

References: Kozlova, 1967, p. 56, Fig. 11; Fryxell & Hasle, 1983, p. 54, Figs. 2–14; Johansen & Fryxell, 1985, p. 161, Figs. 21–23 and 33–35.

**Girdle view:** Valve face flat; mantle extremely low.

**Valve view:** Areolae in radial; partly wavy rows; areolae walls thickened in perivalvar direction (SEM), visible with LM as irregular ribs. One to six central processes; labiate process midway between two marginal strutted processes, all with external tubes.

**Distinctive features:** Irregular ribs superimposed on the areolation although variable in shape and presence.

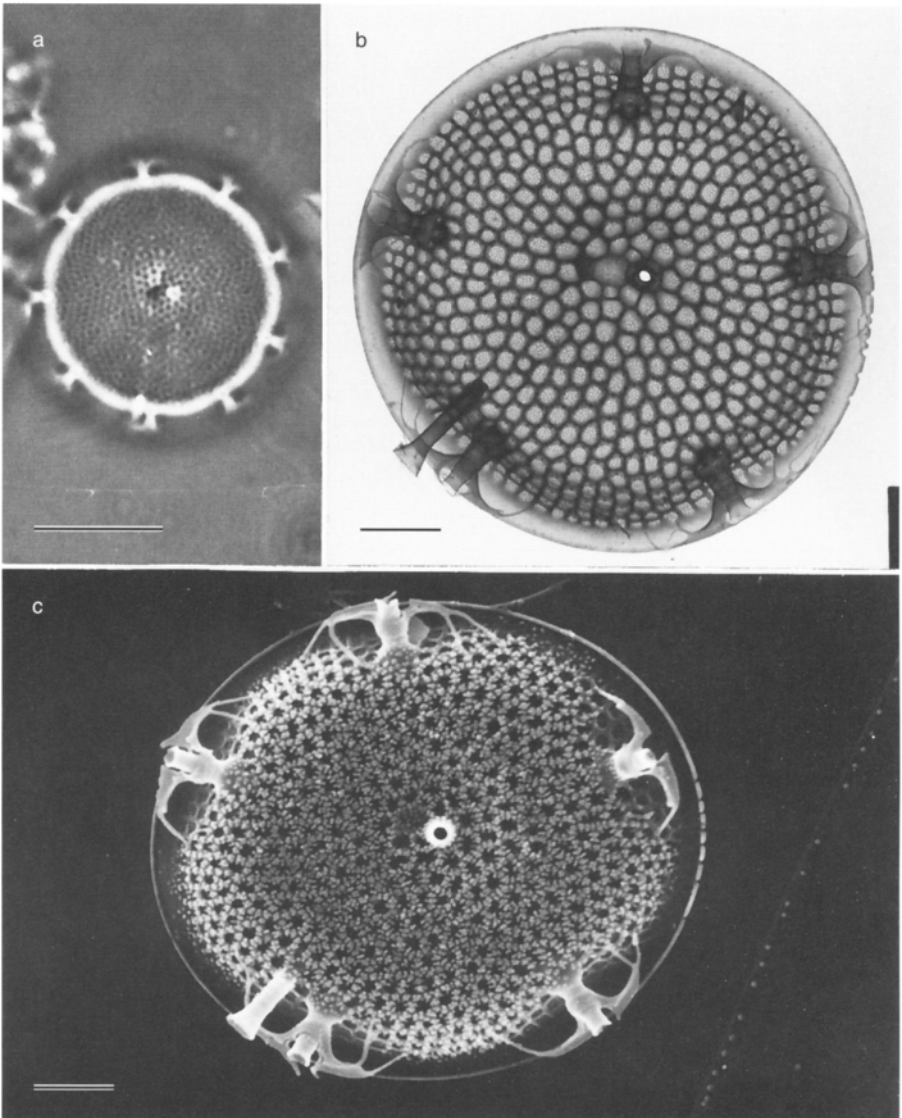

**PLATE 7** Micrographs: single valves. *Thalassiosira curviseriata*: (a) areolae, process pattern, and characteristic outer parts of strutted processes, LM. Scale bar = 5  $\mu\text{m}$ ; (b) as described in a, TEM. Scale bar = 1  $\mu\text{m}$ ; (c) external valve surface, SEM. Scale bar = 1  $\mu\text{m}$ .

TABLE 9 Morphometric Data of *Thalassiosira* spp. Having One to Six Subcentral Strutted Processes

Species	Diameter ( $\mu\text{m}$ )	Valve areolae in 10 $\mu\text{m}$	Marginal proc. in 10 $\mu\text{m}$
<i>T. curviseriata</i>	5–14	26–30	2–3
<i>T. dichotomica</i>	15–26	ca. 30	3–7
<i>T. minima</i>	5–15	30–40	3–6
<i>T. tealata</i> <sup>a</sup>	6.3–9.6	30–40	3

<sup>a</sup> Mentioned in the text for comparison.

### *Thalassiosira minima* Gaarder (Table 9)

**Synonyms:** *Coscinosira floridana* Cooper; *Thalassiosira floridana* (Cooper) Hasle.

**References:** Gaarder, 1951, p. 31, Fig. 18; Cooper, 1958; Hasle, 1972b, p. 544; Hasle, 1976a, Figs. 44 and 45; Hasle, 1980, p. 167, Figs. 1–17; Rivera, 1981, p. 90, Figs. 226–245.

**Girdle view:** Cells rectangular; perivalvar axis less than half to slightly shorter than cell diameter; valve face flat and slightly depressed in the center; mantle low and beveled. Connecting thread as long as or longer than perivalvar axis.

**Valve view:** Areolation barely visible with LM (cleaned, embedded material). Processes distinct although with short external tubes; two central processes, sometimes one, seldom three; labiate process close to one marginal strutted process.

**Distinctive feature:** The two central processes.

**Remarks:** Cells in girdle view are similar to small specimens of *T. nordenskiöldii* as well as to *T. conferta*, *T. binata*, and *T. curviseriata*. The specific distinctions are evident especially in the process shape and pattern when examined as cleaned, embedded material.

### Distribution:

*T. curviseriata*, and *T. minima*—cosmopolitan, exclusive polar regions.

*T. dichotomica*—southern cold water region.

*T. tealata*—Japanese warm water (Takano, 1980)

### 2b. Cluster of central strutted processes.

These species are very similar in girdle view, and despite a fairly large size and mostly coarse valve structure, reliable identification requires cleaned mounted valves.

***Thalassiosira antarctica* Comber (Plate 8, Table 10)**

**Synonyms:** *Thalassiosira antarctica* var. *borealis* G. Fryxell, Doucette, & Hubbard; *Thalassiosira fallax* Meunier (see Syvertsen, 1979, p. 59); Takano, 1990, pp. 184–185.

**References:** Comber, 1896; Meunier, 1910, p. 268, Plate 30, Figs. 1–4; Hustedt, 1930, p. 327, Fig. 162; Hasle & Heimdal, 1968; Syvertsen, 1979, p. 52, Figs. 15–59; Fryxell et al., 1981; Hasle & Syvertsen, 1990b, p. 289, Figs. 25–27.

**Girdle view:** Cells rectangular; valve face flat or slightly convex; mantle slightly sloping. Connecting thread thin, usually as long as or longer than perivalvar axis.

**Valve view:** Areolation radial, bifurcate, occasionally lightly fasciculate. Two to several central processes; two or three rings of marginal strutted processes, located in valve mantle and hardly distinguishable with LM in intact valves; occluded processes present (usually not seen with LM); large labiate process located near valve mantle.

**Distinctive feature:** Valve mantle with more than one ring of processes.

**Remarks:** Fryxell et al. (1981) distinguished between *T. antarctica* var. *antarctica* from the southern hemisphere and *T. antarctica* var. *borealis* from the northern hemisphere. The valves of the vegetative cells are essentially the same but there are some differences in the bands (EM). Both varieties form heavily silicified resting spores, morphologically different from the vegetative cells. Three types of resting spores, endogenous, semiendogenous, and exogenous, have been found together in clonal culture of the northern variety (Oslofjord, Norway; Syvertsen, 1979). Semiendogenous resting spores were observed by Hasle & Heimdal (1968, Fig. 4) on a slide prepared of Comber's original material of *T. antarctica* (British Museum mount No. 59677). The primary valve of the exogenous/semiendogenous resting spores is flattened and the secondary valve is highly vaulted in both varieties. The main differences between the resting spore of var. *antarctica* and var. *borealis* seem to be the overall coarseness of the areolation and the more stable presence of strong, prominent marginal occluded processes, visible with LM, in the nominate variety. The flattened primary resting spore valve of var. *borealis* may easily be confused with

---

**PLATE 8** *Thalassiosira antarctica* var. *borealis*: (a) chain in girdle view; (b) valve with process pattern, open circles indicate occluded processes. From Hasle & Syvertsen (1990a). *Thalassiosira gravida*: (a) chain in girdle view; (b) valve with process pattern. From Hasle & Syvertsen (1990a). *Thalassiosira hyalina*: (a) chain in girdle view; (b) valve with process pattern. From Hasle & Syvertsen (1990a). *Thalassiosira baltica*: (a) chain in girdle view; (b) valve with process pattern. From Hasle & Syvertsen (1990a). *Thalassiosira rotula*: (a) chain in girdle view; (b) valve with process pattern. Scale bars = 10  $\mu\text{m}$ .

*Thalassiosira*

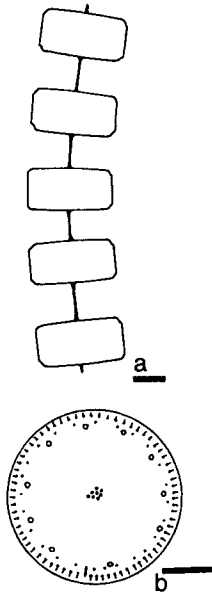

*T. antarctica*  
var. *borealis*

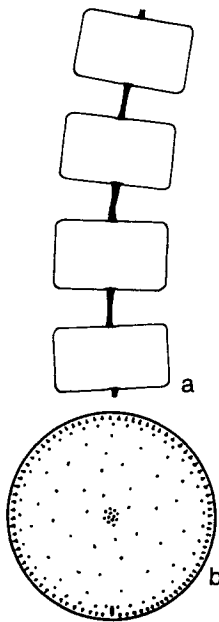

*T. gravida*

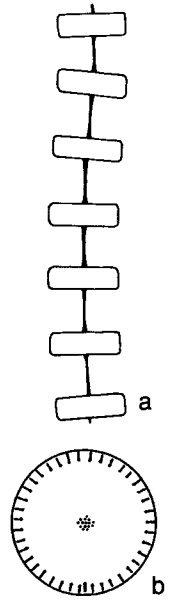

*T. hyalina*

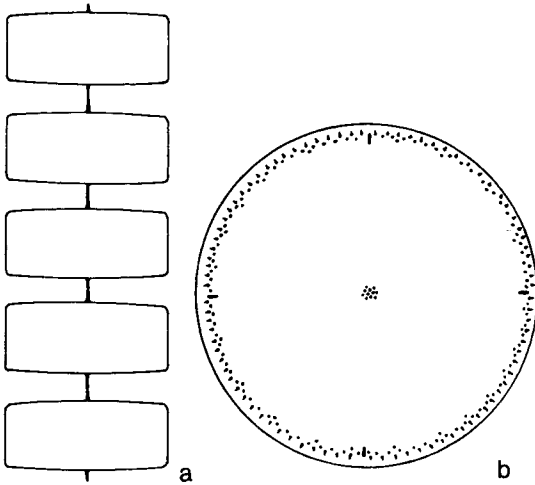

*T. baltica*

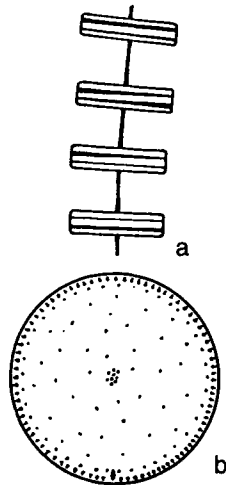

*T. rotula*



TABLE 10 Morphometric Data of *Thalassiosira* spp. with a Cluster of Central Strutted Processes

Species	Diameter ( $\mu\text{m}$ )	Valve areolae in 10 $\mu\text{m}$	Marginal proc. in 10 $\mu\text{m}$
<i>T. antarctica</i>			
var. <i>antarctica</i>	14–50	17–20	— <sup>b</sup>
var. <i>borealis</i>	18–43	20–24	8
<i>T. baltica</i>	20–120	10–20	6–7
<i>T. constricta</i> <sup>a</sup>	18–28	40–60	3–5
<i>T. gerloffii</i> <sup>a</sup>	23–50	8–13	4–6
<i>T. gravida</i>	17–62	20	5–10? <sup>c</sup>
<i>T. hyalina</i>	16–45	13–24	5–9
<i>T. karenae</i> <sup>a</sup>	22–26	35–40	3–4
<i>T. rotula</i>	8–55	18–24	12–15?
<i>T. tumida</i>	21–137	4–14	4–5

<sup>a</sup> Mentioned in the text for comparison.

<sup>b</sup> —, No data.

<sup>c</sup> ?, Data uncertain.

*Thalassiosira gravida*, especially since both have scattered strutted processes on the valve face. The resting spore valve is distinguished from *T. gravida* (see below) by having only one or two strutted processes in the valve center, one or sometimes two definite marginal rows of strutted processes, coarser areolae, and occasionally occluded processes. The vaulted secondary valve of the northern variety is more coarsely silicified than the flattened primary valve and may be identical with *Coscinodiscus subglobosus* Cleve & Grunow in Grunow (1884, p. 84, Plate 4, Figs. 19 and 20), formerly interpreted as resting spore of *T. gravida*. In the same way the resting spore of the southern variety may have been described as *Coscinodiscus (subglobosus var.?) antarcticus* by Grunow (1884, p. 84, Plate 4, Fig. 23). The fact that the resting spores may have been described before the vegetative cells as well as the fact that Cleve (1896a, p. 13) confused *T. antarctica* var. *borealis* and *T. gravida* creates nomenclature complications which require further consideration.

*Thalassiosira baltica* (Grunow) Ostenfeld (Plate 8, Table 10)

**Basionym:** *Coscinodiscus polyacanthus* var. *baltica* Grunow in Cleve & Grunow.

**References:** Cleve & Grunow, 1880, p. 112; Ostenfeld, 1901a, p. 290, Fig. 3; Hustedt, 1930, p. 328, Fig. 164; Hasle, 1978b, p. 266, Figs. 5–11;

Makarova, 1988, p. 63, Plate 33, Figs. 1–13; Hasle & Syvertsen, 1990b, p. 290, Figs. 28–30.

**Girdle view:** Cells almost rectangular; perivalvar axis about one-third to one-half of cell diameter; valve face flat; mantle low and slightly slanting. Connecting thread about twice as long as perivalvar axis.

**Valve view:** Areolation fasciculate. Two to nine central strutted processes; two rings of marginal strutted processes situated on valve mantle together with three or four labiate processes.

**Distinctive features:** Fasciculation and number of labiate processes.

*Thalassiosira gravida* Cleve (Plate 8, Table 10)

**References:** Cleve, 1896a, p. 12, Plate 2, Figs. 14–16; Fryxell, 1975, pp. 133–138; Syvertsen, 1977; Fryxell, 1989, Figs. 19–21.

**Girdle view:** Cells rectangular; valve face flat; mantle low and slightly sloping. Connecting thread thick, especially close to valve surface.

**Valve view:** Hexagonal areolae in radial rows. Numerous central strutted processes and scattered strutted processes on valve face and mantle; one large marginal labiate process.

**Distinctive features:** Connecting thread; hexagonal areolae; scattered strutted processes.

**Remarks:** It should also be noted that *T. gravida* has not been found to form resting spores (Syvertsen, 1977), whereas resting spores corresponding in structure to *C. subglobosus*, regarded by Cleve (1896a) as endocysts of *T. gravida*, have been found as resting spores of *T. antarctica* (Syvertsen, 1979). *Thalassiosira gravida* may appear in mucilage colonies in the Antarctic (Fryxell, 1989).

*Thalassiosira hyalina* (Grunow) Gran (Plate 8, Table 10)

**Basionym:** *Coscinodiscus hyalinus* Grunow in Cleve & Grunow.

**References:** Cleve & Grunow, 1880, p. 113, Plate 7, Fig. 128; Gran, 1897a, p. 16, Plate 1, Figs. 17 and 18; Hustedt, 1930, p. 325, Fig. 159; Hende, 1964, p. 86, Plate 1, Fig. 6.

**Girdle view:** Perivalvar axis about one-third of cell diameter; valve face flat or slightly convex; mantle low and rounded. Connecting thread thick.

**Valve view:** Valve face with radial areolae rows or ribs; mantle always areolated. Two to 15 central strutted processes; one marginal ring of strutted processes with conspicuous external tubes; labiate process taking the place of a marginal strutted process.

**Distinctive features:** Low cells; one ring of marginal processes.

**Remarks:** The well-areolated valves belong most likely to resting spores (or resting cells) which occur in groups of two with no or very short connecting thread (E. Syvertsen, unpublished observations). The Arctic *Thalassiosira constricta* Gaarder, the Antarctic *T. karenae* Semina, as well as *T. gerloffii*

Rivera from South American Antarctic and Subantarctic waters have many central strutted processes and one marginal ring. In contrast to *T. hyalina*, *T. constricta* has resting spores drastically different from the vegetative cells, has higher cells, the marginal strutted processes are wider apart, and the labiate process is midway between two strutted processes (Heimdal, 1971). Except for the distribution and lack of observations of resting spores, *Thalassiosira karenae* is almost identical with *T. constricta* (Semina, 1981a). *Thalassiosira gerloffii* is generally coarsely silicified with a fairly high valve mantle and areolation more similar to *T. angulata* and *T. pacifica* but with marginal processes closer together (G. Hasle, unpublished observations; Rivera, 1981).

***Thalassiosira rotula* Meunier (Plate 8, Table 10)**

**References:** Meunier, 1910, p. 264, Plate 29, Figs. 67–70; Hustedt, 1930, p. 326, Fig. 328; Cupp, 1943, p. 49, Fig. 12; Fryxell, 1975, pp. 95–100; Syvertsen, 1977; Takano, 1990, pp. 226–227.

**Girdle view:** Cells flattened and discoid. The band (copula) next to the valvocopula sometimes broadened, septate ("unevenly thickened"); otherwise as *T. gravida*.

**Valve view:** Valve face with radial ribs and few tangential areola walls (i.e., poorly developed areolae) except on valve mantle; otherwise as *T. gravida*.

**Distinctive features:** Structure of valve face and the band next to valvocopula.

**Remarks:** Experiments indicated that the special copula was formed by nutrient deficiency. The difference between *T. rotula* and *T. gravida* in valve structure seemed to be temperature dependent, thus indicating a conspecificity or close relationship between the two taxa (Syvertsen, 1977).

***Thalassiosira tumida* (Janisch) Hasle in Hasle et al. (Table 10)**

**Basionym:** *Coscinodiscus tumidus* Janisch in A. Schmidt.

**References:** Schmidt, 1878, Plate 59, Figs. 38 and 39; Hasle et al., 1971; Johansen & Fryxell, 1985, p. 176, Figs. 28–32; Fryxell, 1989, Fig. 18.

**Girdle view:** Cells rectangular; valve face flat with slight, central depression or lightly convex; mantle rounded. Several connecting threads twinned to form one thick thread.

**Valve view:** Areolation varying from linear to eccentric to fasciculate. Numerous strutted processes in valve center in an irregular ring, sometimes with processes also inside the ring; strutted processes scattered on valve face; one regular marginal ring of strutted processes including three to nine labiate processes.

**Distinctive features:** Arrangement of central processes; number of labiate processes.

**Remarks:** *Thalassiosira tumida* has been regarded as an extremely variable species. Fryxell et al. (1986a) hypothesized the existence of two varieties, and Fryxell (1988) found a certain relationship between temperature and variation in areola pattern.

**Distribution:**

*T. antarctica* var. *antarctica*, *T. karenae*, and *T. tumida*—southern cold water region.

*T. antarctica* var. *borealis*, *T. constricta*, and *T. hyalina*—northern cold water region to temperate.

*T. gerloffii*—Chilean coastal waters, southern Atlantic Ocean (Rivera, 1981, p. 80; Lange, 1985), southern cold water region (Johansen & Fryxell, 1985).

*T. gravida* and *T. rotula*—cosmopolitan if regarded as one species. Diatoms identified as *T. gravida* from the Antarctic may belong to a separate taxon.

*T. baltica*—brackish water (e.g., Baltic Sea and the Arctic).

2c. +/- Modified ring of subcentral strutted processes.

*Thalassiosira anguste-lineata* (A. Schmidt) G. Fryxell & Hasle (Plate 9, Table 11)

**Basionym:** *Coscinodiscus anguste-lineatus* A. Schmidt.

**Synonyms:** *Coscinodiscus polychordus* Gran; *Thalassiosira polychorda* (Gran) Jørgensen; *Coscosira polychorda* (Gran) Gran.

**References:** Schmidt, 1878, Plate 59, Fig. 34; Gran, 1897b, p. 30, Plate 2, Fig. 33, Plate 4, Fig. 56; Jørgensen, 1899, p. 15; Gran, 1900, p. 115; Hustedt, 1930, p. 317, Fig. 154; Cupp, 1943, p. 44, Fig. 7; Hendeby, 1964, p. 89, Plate 1, Fig. 11; Hasle, 1972b; Fryxell & Hasle, 1977, p. 73, Figs. 22–34; Rivera, 1981, p. 45, Figs. 29–47; Makarova, 1988, p. 55, Plate 25, Figs. 10–13, Plate 26, Figs. 1–14; Takano, 1990, pp. 182–183.

**Girdle view:** Cells rectangular; valve face flat or slightly curved; mantle rounded. Many connecting threads in groups at some distance from valve center.

**Valve view:** Areolation varying from linear to eccentric to fasciculate. Central strutted processes in arcs in a ring at some distance from valve center, each arc with one to nine processes. Strutted processes with conspicuous external tubes in one marginal ring including one labiate process.

**Distinctive features:** Arrangement of central processes, coarse marginal processes.

**Remarks:** The subcentral strutted processes; of coarsely silicified *T. anguste-lineata* specimens are often difficult to recognize, and these diatoms may

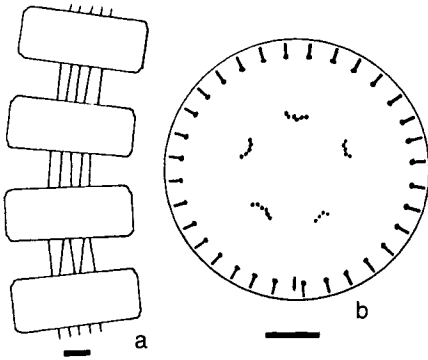
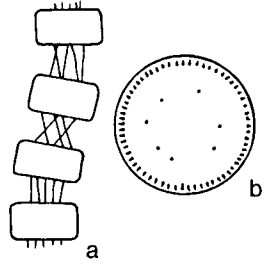
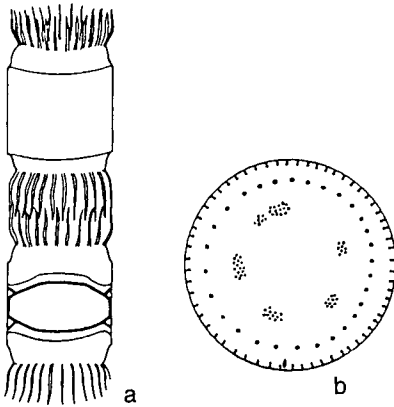
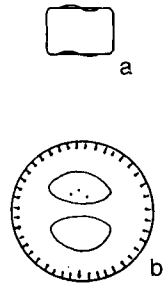
Thalassiosira*T. anguste-lineata**T. kushirensis**T. australis**T. hyperborea*

**PLATE 9** *Thalassiosira anguste-lineata*: (a) chain in girdle view; (b) valve, groups of subcentral processes in a modified ring. From Hasle & Syvertsen (1990a). *Thalassiosira kushirensis*: (a) chain in girdle view; (b) valve, single subcentral processes in a modified ring. From Hasle & Syvertsen (1990a). *Thalassiosira australis*: (a) two cells in girdle view, lower one with endogenous resting spore and rudimentary valves. Marginal processes evident; (b) valve with irregular groups of strutted processes in a modified ring. *Thalassiosira hyperborea*: (a) cell in girdle view with valve undulation; (b) valve with process pattern. From Hasle & Syvertsen (1990a). Scale bars = 10  $\mu\text{m}$ .

TABLE 11 Morphometric Data of *Thalassiosira* spp. with a Modified Ring of Subcentral Struttred Processes

Species	Diameter ( $\mu\text{m}$ )	Valve areolae in 10 $\mu\text{m}$	Marginal proc. in 10 $\mu\text{m}$
<i>T. anguste-lineata</i>	14–78	8–18	3–6
<i>T. australis</i>	23–56	11–16	4–9
<i>T. hyperborea</i>	16–70	8–18	3–5
<i>T. kushirensis</i> <sup>a</sup>	8–35	15–24	7–8
<i>T. mediterranea</i>	6–20	ca. 30	3–6
<i>T. weissflogii</i>	5–32	30–40? <sup>b</sup>	9–16

<sup>a</sup> Mentioned in the text for comparison.

<sup>b</sup> ?, Data uncertain.

have been reported as “*Coscinodiscus lineatus*” or “*Coscinodiscus sublineatus*.” *Thalassiosira kushirensis* Takano (Plate 9, Table 11) is a smaller species similar to *T. anguste-lineata*. It occurs in short chains, as solitary cells or in mucilage, has single central struttred processes in an irregular ring, and areolae in radially clustered rows (Takano, 1985).

#### *Thalassiosira australis* M. Peragallo (Plate 9, Table 11)

**References:** Peragallo, 1921, p. 84, Plate 4, Fig. 17; Fryxell, 1977, p. 96, Figs. 1–12; Johansen & Fryxell, 1985, p. 158, Figs. 19, 20, and 46–48; Syvertsen, 1985, p. 116, Figs. 15–27; Fryxell, 1989, Fig. 22.

**Girdle view:** Cells cylindrical; valve face flat or slightly concave; mantle high, steep, and slightly slanting; distance between cells in chains about half as long as perivalvar axis. Long occluded processes.

**Valve view:** Areolation fasciculate. Subcentral struttred processes in three to seven clusters in a ring midway between valve center and margin; one marginal ring of struttred processes not easily seen with LM because of the high steep mantle; one ring of occluded processes on valve mantle and one labiate process displaced toward valve center.

**Distinctive features:** Arrangement of central struttred processes; size, shape, and number of occluded processes.

**Remarks:** The endogenous resting spores of *T. australis* differ distinctly from the vegetative cells, having a central cluster of struttred processes, one marginal ring of coarse, trumpet-shaped struttred processes situated close together, and a labiate process with long, thick external tube, thus being similar to *T. gerloffii* (Syvertsen, 1985).

*Thalassiosira hyperborea* (Grunow) Hasle (Plate 9, Table 11)

**Basionym:** *Coscinodiscus* (*lacustris* var.?) *hyperboreus* Grunow.

**References:** Grunow, 1884, p. 85, Plate 4, Fig. 26; Hasle & Lange, 1989, p. 125, Figs. 20–22, 28–33.

**Girdle view:** Cells almost rectangular; valve face tangentially undulated; mantle low and fairly steep. Chains not observed.

**Valve view:** Hexagonal areolae in radial rows. The deep or the raised part of the undulated valve surface, or both, sigmoid in outline. One to eight (sometimes more) separated strutted processes in no particular pattern, mostly on the externally raised part of the valve (occasionally discernible with LM); one ring of coarse strutted processes close to valve margin; one labiate process. Coarsely silicified interstriae extending from the marginal processes, visible at a certain focus.

**Distinctive features:** Shape of valve; distinct ribs associated with marginal processes.

**Remarks:** Four varieties of *T. hyperborea* were distinguished based on areola size and slight differences in process pattern and structure. The diatoms from the Baltic Sea and adjacent waters known as *Coscinodiscus lacustris* Grunow, *Coscinodiscus lacustris* var. *pelagica* Cleve-Euler, *Thalassiosira lacustris* (Grunow) Hasle, and *Thalassiosira bramaputrae* (Ehrenberg) Håkansson & Locker are identical with *T. hyperborea* var. *pelagica* (Cleve-Euler) Hasle (Hasle & Lange, 1989, p. 129). The nominate variety, *T. hyperborea* var. *hyperborea* (Grunow) Hasle belongs to the Arctic, probably brackish water. The fresh- or brackish water species *T. lacustris* (Grunow) Hasle, *T. gessneri* Hustedt, and *T. australiensis* (Grunow) Hasle have tangentially undulated valves but differ from *T. hyperborea*, especially in internal valve structure (Hasle & Lange, 1989).

*Thalassiosira mediterranea* (Schröder) Hasle (Table 11)

**Basionym:** *Coscosira mediterranea* Schröder.

**Synonym:** *Thalassiosira stellaris* Hasle & Guillard in Fryxell & Hasle.

**References:** Schröder, 1911, p. 28, Fig. 5; Hustedt, 1930, p. 318, Fig. 156; Hasle, 1972b, p. 544; Fryxell & Hasle, 1977, p. 72, Figs. 16–21; Rivera, 1981, p. 120, Figs. 353–358; Hasle, 1990.

**Girdle view:** Pervalvar axis usually shorter than diameter; valve surface convex. Several connecting threads approximately as long as or slightly longer than perivalvar axis.

**Valve view:** Areolation not resolved with LM; two to eight radial rays extending from a central annulus to about midway between valve center and margin, each ending at a strutted process. One ring of strutted processes close to valve margin including a labiate process located about midway between two strutted ones.

**Distinctive features:** Radial rays and regular ring of single strutted processes midway between valve center and margin.

*Thalassiosira weissflogii* (Grunow) G. Fryxell & Hasle (Table 11)

**Basionym:** *Micropodiscus weissflogii* Grunow in Van Heurck.

**Synonym:** *Thalassiosira fluviatilis* Hustedt.

**References:** Van Heurck, 1880–1885, p. 210; Hustedt, 1926; Hustedt, 1930, p. 329, Fig. 165; Fryxell & Hasle, 1977, p. 68, Figs. 1–15; Takano, 1990, pp. 234–235.

**Girdle view:** Cells rectangular; perivalvar axis usually less than the diameter; valve flat in the center, valve mantle fairly steep or rounded.

**Valve view:** Irregular areolation; areolae small or ill defined (LM).

Irregular ring of strutted processes (2–28) at some distance from valve center; one marginal ring of strutted processes including one very large labiate process taking the place of a strutted process.

**Distinctive features:** Meshwork on valve surface; irregular ring of central strutted processes.

**Remarks:** *Thalassiosira weissflogii* is often found in bloom proportions in brackish waters, apparently without chain formation although chains have been observed in natural samples (G. Hasle, personal observations).

**Distribution:**

*T. australis*—southern cold water region.

*T. mediterranea*—warm water region to temperate.

*T. anguste-lineata*—cosmopolitan.

*T. hyperborea*—brackish water, e.g., Baltic Sea and the Arctic.

*T. weissflogii*—fresh- to brackish water, cosmopolitan?

*T. kushirensis*—Japanese waters (Takano, 1985), North Atlantic waters (G. Hasle and E. Syvertsen, personal observations) including Skagerrak (Lange et al., 1992).

3a. No strutted processes on valve face.

*Thalassiosira leptopus* (Grunow) Hasle & G. Fryxell (Plate 10, Table 12)

**Basionym:** *Coscinodiscus (lineatus var.?) leptopus* Grunow in Van Heurck.

**Synonyms:** *Coscinodiscus lineatus* Ehrenberg; *Coscinodiscus pseudolineatus* Pantocsek; *Coscinodiscus praelineatus* Jousé.

**References:** Ehrenberg, 1839, p. 129; Ehrenberg, 1841a, p. 146, Plate 3, Fig. 4; Van Heurck, 1880–1885, Plate 131, Figs. 5 and 6; Hustedt, 1930, p. 392, Fig. 204; Jousé, 1968, p. 15, Plate 2, Fig. 1; Hasle & Fryxell, 1977b, p. 20, Figs. 1–14; Hasle & Syvertsen, 1984.

**Girdle view:** Valve face flat; mantle low and evenly slanting.



*Thalassiosira*

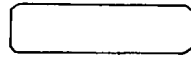

a

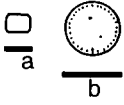

*T. guillardii*

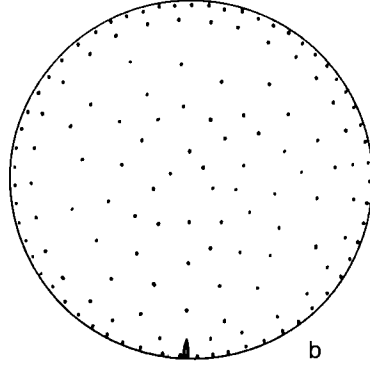

b

*T. lentiginosa*

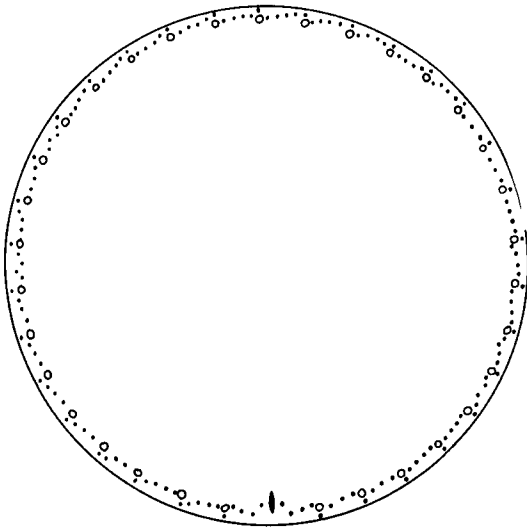

*T. leptopus*



a

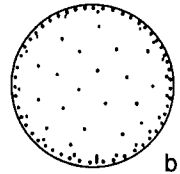

b

*T. lineata*

TABLE 12 Morphometric Data of *Thalassiosira* spp. with Zero to Three Subcentral Struttred Processes

Species	Diameter ( $\mu\text{m}$ )	Valve areolae or ribs in 10 $\mu\text{m}$	Marginal proc. in 10 $\mu\text{m}$
<i>T. guillardii</i>	4–14	30–40 <sup>a</sup> ; 70–80 <sup>b</sup>	7–8
<i>T. leptopus</i>	26–165	4–7	3–8
<i>T. pseudonana</i>	2.3–5.5	50–70	6–14

<sup>a</sup> Valve face.

<sup>b</sup> Valve mantle.

**Valve view:** Areolae on valve face in straight tangential rows (lineatus structure), those on the mantle smaller and irregularly arranged; a central areola larger than the others. Small struttred processes in two to three marginal rings not revealed with LM; one ring of coarser processes further away from margin composed of one large labiate process and evenly spaced coarse, short occluded processes.

**Distinctive features:** Large labiate process and occluded processes; larger central areola.

3b. Zero to three subcentral struttred processes.

*Thalassiosira guillardii* Hasle (Plates 10 and 11, Table 12)

**Synonym:** *Cyclotella nana* Guillard clone 7–15 in Guillard & Ryther.

**References:** Guillard & Ryther, 1962, Plate 2, Figs. 2A and 2B; Hasle, 1978b, p. 274, Figs. 28–50; Makarova et al., 1979, p. 924, Plate 3, Figs. 8–10.

**Girdle view:** Cells almost rectangular; perivalvar axis from about one-third to as long as cell diameter. Colonies not observed.

**Valve view:** Areolation not resolved with LM; slightly raised siliceous ribs radiating from an annulus; less distinct in outer half of valve face (EM). Subcentral struttred processes located about one-third to one-half radius away from valve center; one marginal ring of regularly spaced struttred processes; one labiate process taking the place of a struttred process.

**Distinctive features:** When compared with *T. pseudonana*, the location of the labiate process and an apparent lack of areolation.

PLATE 10 *Thalassiosira guillardii*: (a) cell in girdle view; (b) valve with two subcentral processes. *Thalassiosira lentiginosa*: (a) cell in girdle view; (b) valve with process pattern. *Thalassiosira leptopus*: valve with pattern of marginal struttred and occluded (open circles) processes. *Thalassiosira lineata*: (a) cell in girdle view; (b) valve with process pattern. Scale bars = 10  $\mu\text{m}$ .

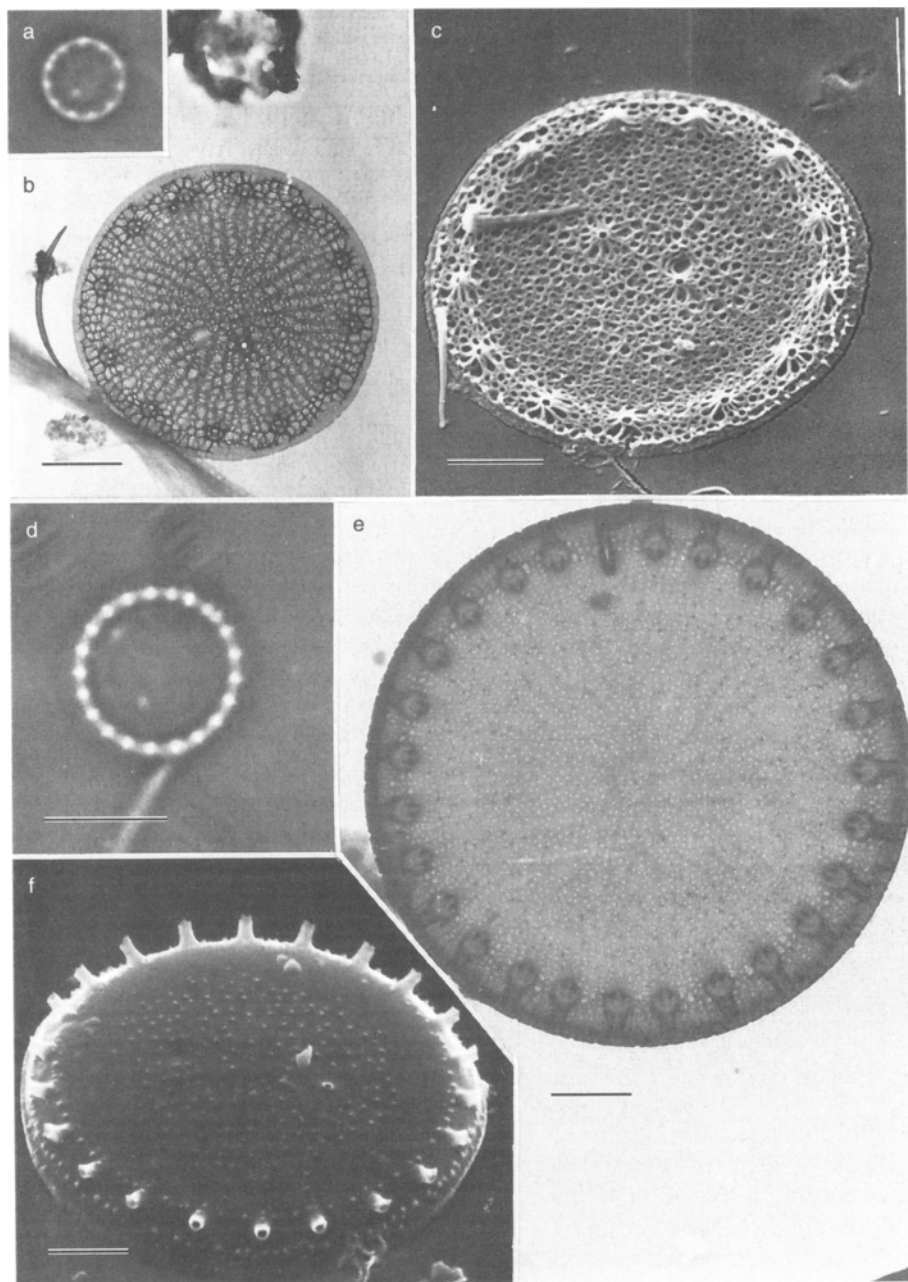

PLATE 11 Micrographs: single valves. *Thalassiosira pseudonana* (a–c): (a) valve with process pattern, LM. Scale bar = 5  $\mu\text{m}$ ; (b) typical valve structure, TEM. Scale bar = 1  $\mu\text{m}$ ; (c) external valve structure, SEM. Scale bar = 1  $\mu\text{m}$ . *Thalassiosira guillardii* (d–f): (d) valve with process pattern, LM. Scale bar = 5  $\mu\text{m}$ ; (e) valve process pattern, TEM. Scale bar = 1  $\mu\text{m}$ ; (f) external valve surface, SEM. Scale bar = 1  $\mu\text{m}$ .

***Thalassiosira pseudonana*** Hasle & Heimdal (Plate 11, Table 12)

**Synonym:** *Cyclotella nana* Guillard clone 3H in Guillard & Ryther.

**References:** Guillard & Ryther, 1962, Plate 1, Fig. 1A; Hasle & Heimdal, 1970, p. 565, Figs. 27–38; Hasle, 1976b, p. 105, Figs. 11–16; Makarova et al., 1979, p. 923, Plate 2, Figs. 1–8, Plate 3, Figs. 1–7; Hasle, 1983a, Table 1; Simonsen, 1987, Plate 657, Figs. 20 and 21 (?), but probably not Figs. 13–19.

**Girdle view:** Cells rectangular; perivalvar axis shorter than or as long as cell diameter; valve face flat or slightly convex; mantle rounded. Colonies not observed.

**Valve view:** Valve structure not revealed with LM. Process pattern distinct in cleaned, mounted material. One marginal ring of strutted processes including one labiate process midway between two strutted ones.

**Distinctive features:** When compared with *Thalassiosira oceanica*, the location and number of central strutted processes.

**Remarks:** *Thalassiosira pseudonana* is an extremely variable species, and a precise description based on LM observations can hardly be given. The diatom here named *T. pseudonana* is identical with specimens in Hustedt's samples from Wümmen (the type locality of *Cyclotella nana*) and with clonal cultures established from Wümmen (Hasle, 1976b). The kind of valve structure, radial ribs, a more or less developed areolation as well as a central annulus, or a network of cross venation (as in *T. weissflogii*) are apparently dependent on the amount of silica available (Paasche, 1973). Chang & Steinberg (1989) "ordered *T. pseudonana* back to *Cyclotella*." Although *T. pseudonana* has characters not exactly consistent with the *Thalassiosira* type, it is hard to see that it is any closer to the *Cyclotella* type (e.g., Håkansson, 1989).

3c. Strutted processes on the whole valve face; no particular central or subcentral process.

***Thalassiosira lentiginosa*** (Janisch) G. Fryxell (Plate 10, Table 13)

**Basionym:** *Coscinodiscus lentiginosus* Janisch in A. Schmidt.

**References:** Schmidt, 1878, Plate 58, Fig. 11; Fryxell, 1977, p. 100, Figs. 13 and 14; Johansen & Fryxell, 1985, p. 170, Figs. 7, 49, and 50.

**Girdle view:** Cells narrowly rectangular; perivalvar axis about one-fourth diameter; valve flat; mantle low. Not observed in chains (Fryxell, 1977).

**Valve view:** Areolation usually fasciculated. Strutted processes evenly scattered over valve face, resembling small areolae (not easily seen with LM); one marginal ring of inconspicuous strutted processes lacking external tubes; a large easily visible marginal labiate process.

**Distinctive features:** Labiate process; fasciculate valve structure.

TABLE 13 Morphometric Data of *Thalassiosira* spp. with Strutted Processes on the Whole Valve Face and No Central or Subcentral Process

Species	Diameter ( $\mu\text{m}$ )	Valve areolae or ribs in 10 $\mu\text{m}$	Marginal proc. in 10 $\mu\text{m}$
<i>T. lentiginosa</i>	47–95	7–9	— <sup>b</sup>
<i>T. lineata</i>	9–45	8–16	5–6
<i>T. lineoides</i> <sup>a</sup>	38.5–50	9–11	3–5

<sup>a</sup> Mentioned in the text for comparison.

<sup>b</sup> —, No data.

### *Thalassiosira lineata* Jousé (Plate 10, Table 13)

**References:** Jousé, 1968, p. 13, Plate 1, Figs. 1 and 2; Hasle, 1976a, Figs. 22–28; Hasle & Fryxell, 1977b, p. 22, Figs. 15–25.

**Girdle view:** Valve face flat; mantle low. Observed as single cells.

**Valve view:** Hexagonal areolae in strictly straight rows throughout the whole valve face. Strutted processes scattered over the whole valve; two marginal rings of strutted processes (not revealed with LM); one large labiate process.

**Distinctive features:** Straight areola rows; distinct strutted processes on the valve face (LM).

**Remarks:** The scattered processes are readily seen in water mounts.

*Thalassiosira lineoides* Herzig & G. Fryxell is distinct from *T. lineata* by certain differences in the location and structure of the scattered processes, mainly discernible with SEM (Herzig & Fryxell, 1986).

### **Distribution:**

*T. lentiginosa*—southern cold water region.

*T. lineata*—warm water region.

*T. lineoides*—warm water region to temperate(?).

B. Labiate process on valve face.

1. One central or subcentral strutted process.

### *Thalassiosira bioculata* (Grunow) Ostenfeld (Plate 12, Table 14)

**Basionym:** *Coscinodiscus bioculatus* Grunow.

**References:** Grunow, 1884, pp. 107 and 108, Plate 3, Fig. 30, Plate 4, Fig. 2; Ostenfeld, 1903, p. 564, Fig. 120; Meunier, 1910, p. 266, Plate 29, Figs. 45–62; Hustedt, 1930, p. 331, Fig. 168.

**Girdle view:** Cells cylindrical; perivalvar axis up to twice as long as cell diameter; valve face flat or slightly convex; mantle low and rounded. Connecting thread thin and short.

Thalassiosira*T. bioculata**T. gracilis**T. oestrupii**T. poroseriata**T. trifulta*

PLATE 12 *Thalassiosira bioculata*: (a) chain in girdle view; (b) valve with one central strutted and one subcentral labiate process. From Hasle & Syvertsen (1990a). *Thalassiosira gracilis*: (a) cell in girdle view; (b) valve with submarginal labiate process. *Thalassiosira oestrupii*: (a) cell in girdle view, striated valvocopula; (b) valve with process pattern. *Thalassiosira poroseriata*: (a) chain in girdle view; (b) valve with irregular line of central strutted processes. From Hasle & Syvertsen (1990a). *Thalassiosira trifulta*: (a) cell in girdle view; (b) valve with V-shaped configuration of central strutted processes. From Hasle & Syvertsen (1990a). Scale bars = 10  $\mu\text{m}$ .

TABLE 14 Morphometric Data of *Thalassiosira* spp. with One Central or Subcentral Strutted Process

Species	Diameter ( $\mu\text{m}$ )	Valve areolae in 10 $\mu\text{m}$	Distance between marginal proc. ( $\mu\text{m}$ ) <sup>a</sup>
<i>T. bioculata</i>	20–60	16–20	5–7
<i>T. gracilis</i>			
var. <i>gracilis</i>	5–28	8–20? <sup>b</sup>	3.0–3.5
var. <i>expecta</i>	7–15	14–20?	2.5–3.5
<i>T. oestrupii</i>			
var. <i>oestrupii</i>	7–60	6–12	0.8–1.9
var. <i>venrickae</i>	5.5–39	6–11	4–7
<i>T. perpustakaan</i>	6–15	18–22	8–10
<i>T. proschkinae</i>	3–11.5	25–30	ca. 1.5
<i>T. rosulata</i> <sup>c</sup>	7–22	— <sup>d</sup>	2–3 in 10 $\mu\text{m}$

<sup>a</sup> Proc., processes.

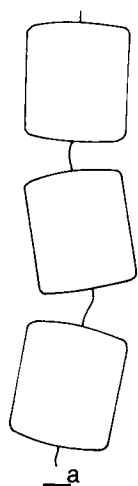
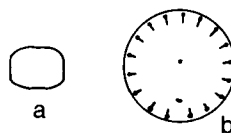
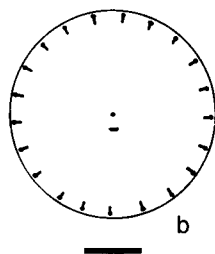
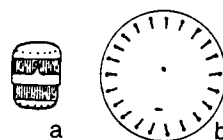
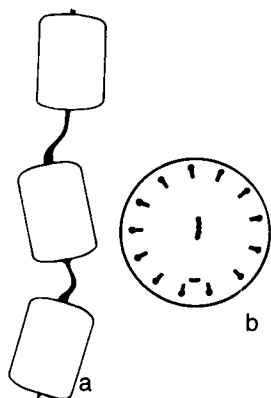
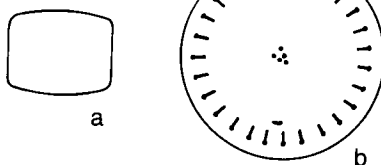
<sup>b</sup> ?, Data uncertain.

<sup>c</sup> Mentioned in the text for comparison.

<sup>d</sup> —, No data.

**Valve view:** Areolation fasciculated, made up of rows of hexagonal areolae or radial ribs. A single strutted process precisely in valve center, a labiate process a little off centered, and long internal parts of marginal strutted processes readily seen at a certain focus.

**Distinctive features:** Cylindrical cells; labiate process close to central strutted process; long internal process tubes.

**Remarks:** Our study material includes Grunow's slides as well as our own samples from the Arctic. Our material from other geographical areas includes diatoms similar to *Thalassiosira bioculata* in gross morphology. At present we are unable to tell whether they belong to the same taxon as the Arctic *T. bioculata*. A certain variability of *T. bioculata* is manifest by the fact that Grunow (1884) described the smaller var. *exigua* in addition to the nominate variety. *Thalassiosira bioculata* forms low, heavily silicified semiendogenous resting spores with convex, coarsely areolated primary and secondary valves (Meunier, 1910).

*Thalassiosira gracilis* (Karsten) Hustedt var. *gracilis* (Plate 12, Table 14)

**Basionym:** *Coscinodiscus gracilis* Karsten.

**References:** Karsten, 1905, p. 78, Plate 3, Fig. 4; Hustedt, 1958a, p. 109, Figs. 4–7; Fryxell & Hasle, 1979a, p. 382, Figs. 12–22; Johansen & Fryxell, 1985, p. 168, Figs. 8, 58 and 59.

*Thalassiosira gracilis* var. *expecta* (VanLandingham) G. Fryxell & Hasle (Plate 12, Table 14)

**Basionym:** *Thalassiosira expecta* VanLandingham.

**Synonym:** *Thalassiosira delicatula* Hustedt non *Thalassiosira delicatula* Ostenfeld in Borgert.

**References:** Hustedt, 1958a, pp. 110, Figs. 8–10; VanLandingham, 1978, p. 3994; Fryxell & Hasle, 1979a, p. 384, Figs. 23–28; Johansen & Fryxell, 1985, p. 170, Figs. 8 and 60–63.

**Girdle view:** Cells discoid; valve center mainly flat; rest of valve evenly rounded. Connecting thread fairly thin.

**Valve view:** Areolae in central part large, widely spaced and irregularly arranged, smaller and less spaced on outer part of valve face and on mantle. Central strutted process a little off centered; single labiate process on border between valve face and mantle (EM).

**Distinctive features:** Heavily silicified, rounded cells; larger areolae in central part of valve.

**Remarks:** *Thalassiosira gracilis* var. *expecta* differs from *T. gracilis* var. *gracilis* mainly by smaller areolae on the central part of valve face. Whereas the processes of heavily silicified specimens of var. *gracilis* may be difficult to see with LM, those of var. *expecta* are readily observed when focusing on their longer internal parts (Hustedt, 1958a; Fryxell & Hasle, 1979a; Johansen & Fryxell 1985).

*Thalassiosira oestrupii* (Ostenfeld) Hasle (Plate 12, Table 14)

**Basionym:** *Coscinosira oestrupii* Ostenfeld.

**References:** Ostenfeld, 1900, p. 52; Hustedt, 1930, p. 318, Fig. 155; Hasle, 1972b, p. 544; Fryxell & Hasle, 1980.

**Girdle view:** Pervalvar axis half to twice the diameter; valve face flat or slightly convex; mantle low and rounded; valvocopula striated. Cells in chains united by a thread from the central strutted process.

**Valve view:** Areolae usually larger in central part of valve than closer to the margin, sometimes in sublinear array. One nearly central strutted process; labiate process usually one or two areolae distant.

**Distinctive features:** Striated valvocopula; coarse areolation.

**Remarks:** *Thalassiosira oestrupii* var. *venrickae* G. Fryxell & Hasle is distinguished from *T. oestrupii* var. *oestrupii* by a distinct eccentric areola pattern and by more widely separated marginal processes. The labiate as well as the strutted processes are discernible with LM (Fryxell & Hasle, 1980).

*Thalassiosira perpusilla* Kozlova (Table 14)

**References:** Kozlova, 1967, p. 60, Figs. 12 and 13; Fryxell & Hasle, 1979a, p. 380, Figs. 1–11; Johansen & Fryxell, 1985, p. 173, Figs. 5 and 53–55.



**Girdle view:** Valve evenly rounded. No observations on chain formation.

**Valve view:** Areolae in irregular radial rows. Nearly central strutted process; labiate process eccentric; widely separated marginal processes.

**Distinctive feature:** Few marginal strutted processes.

**Remarks:** The processes are readily seen with LM due to the light silicification of the valves. *Thalassiosira rosulata* Takano (Takano, 1985, p. 3) is similar to *T. perpusilla* as well as to small specimens which may belong to *T. bioculata*. The labiate process of *T. rosulata* is closer to the valve margin than those of *T. perpusilla* and *T. bioculata*, and *T. rosulata* is similar to *T. bioculata* regarding valve structure and distance between marginal strutted processes.

*Thalassiosira proschkinae* Makarova in Makarova et al. (Plate 13, Table 14)

**References:** Makarova et al., 1979, p. 922, Plate 1, Figs. 1–7; Makarova, 1988, p. 80, Plate 51, Figs. 13–22; Feibicke et al., 1990; Takano, 1990, pp. 220–221.

**Girdle view:** Cells low cylindrical; valve face flat; mantle low. A few large chloroplasts. Cells in cultures as well as in natural samples found entangled with threads in large colonies.

**Valve view:** Areolae in curved tangential rows (eccentric structure). Central strutted process and labiate process close together and marginal strutted processes closely spaced, all readily seen with LM on cleaned valves mounted in a medium of a high refractive index.

**Distinctive features:** Marginal strutted processes not as widely spaced, central strutted and labiate processes closer and areolae smaller than those in *T. perpusilla*, which is the most similar species.

**Remarks:** Makarova (1988) reduced *Thalassiosira spinulata* Takano in rank to *T. proschkinae* var. *spinulata* (Takano) Makarova. Our observations on cultures and natural samples showed that *T. spinulata* is certainly no distinct species. The two varieties can hardly be distinguished with LM.

---

PLATE 13 Micrographs: single valves. *Thalassiosira proschkinae* (a–c): (a) valves with areola and process patterns distinct, LM. Scale bar = 5  $\mu\text{m}$ ; (b) valves with processes, areolae, and cribra, TEM. Scale bar = 1  $\mu\text{m}$ ; (c) external valve surface, SEM. Scale bar = 1  $\mu\text{m}$ . *Thalassiosira mala* (d–f): (d) valves with processes, LM. Scale bar = 5  $\mu\text{m}$ ; (e) valve with process pattern, areolae, and cribra, TEM. Scale bar = 1  $\mu\text{m}$ ; (f) external valve structure, areolae with foramina, SEM. Scale bar = 1  $\mu\text{m}$ . *Thalassiosira oceanica* (g–i): (g) valves with process pattern, LM. Scale bar = 5  $\mu\text{m}$ ; (h) areolation and processes, TEM. Scale bar = 1  $\mu\text{m}$ ; (i) external view of areolation and processes, SEM. Scale bar = 1  $\mu\text{m}$ .

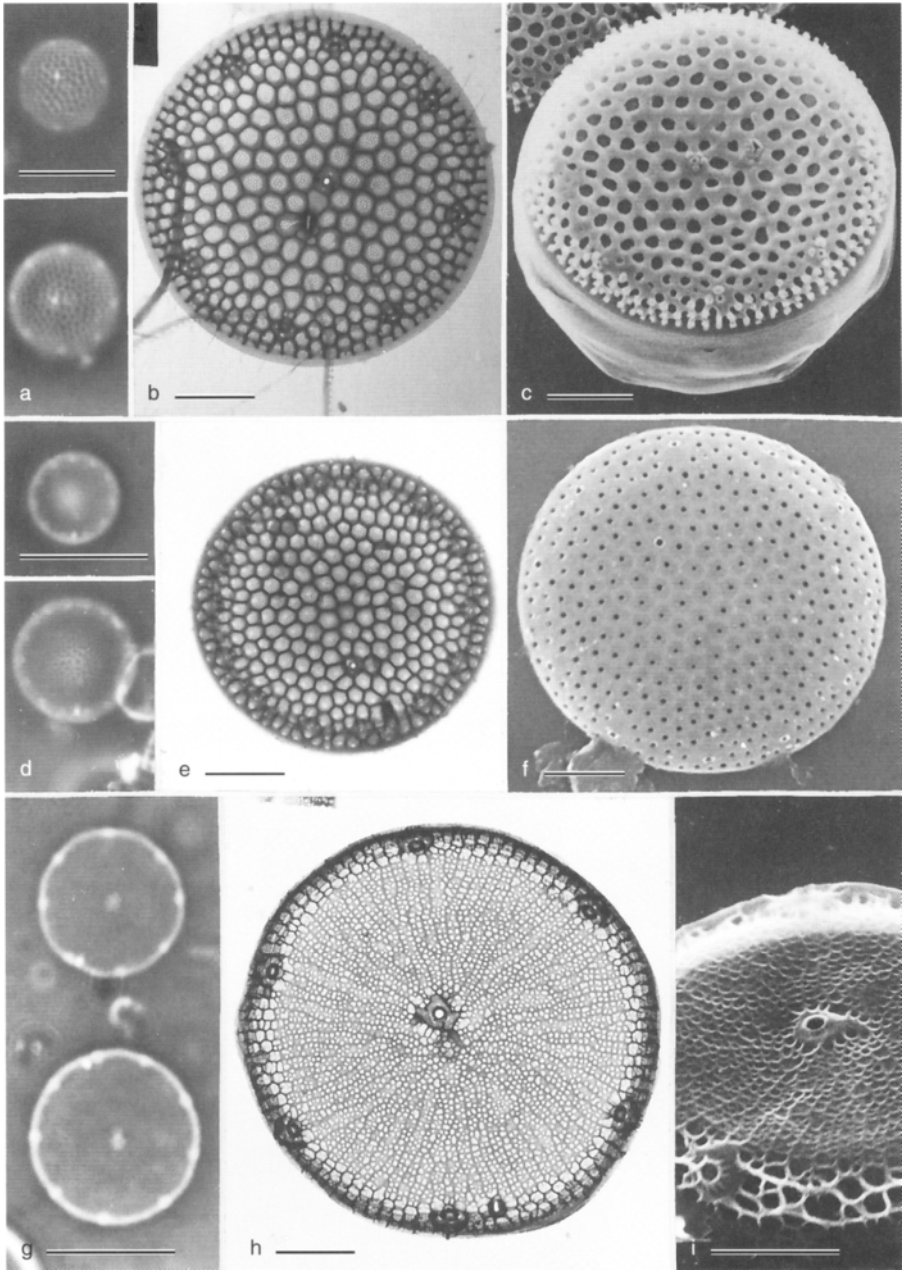

**Distribution:**

- T. gracilis*, and *T. perpusilla*—southern cold water region.  
*T. oestrupii*—warm water region to temperate.  
*T. proschkinae*—cosmopolitan (found as far north as 79°N).  
*T. bioculata*—northern cold water region?  
*T. rosulata*—Japanese waters.

2a. Cluster of central strutted processes.

*Thalassiosira ritscheri* (Hustedt) Hasle in Hasle & Heimdal (Table 15)

**Basionym:** *Coscinodiscus ritscheri* Hustedt.

**References:** Hustedt, 1958a, p. 19, Figs. 44–46; Hasle & Heimdal, 1970, p. 569, Figs. 39–43; Johansen & Fryxell, 1985, p. 176, Figs. 14, 56, and 57.

**Girdle view:** Valve face slightly convex. Chain formation by numerous central threads.

**Valve view:** Areolation fasciculated, sublinear or linear. Labiate process a few (two or three?) areolae away from the central cluster of strutted processes.

**Distinctive feature:** Location of strutted and labiate processes.

2b. One or two rows of central to subcentral strutted processes.

TABLE 15 Morphometric Data of *Thalassiosira* spp. with More Than One Central Strutted Process

Species	Diameter (μm)	Valve areolae in 10 μm	Marginal proc. <sup>a</sup> in 10 μm
<i>T. confusa</i> <sup>b</sup>	22–28	10–11	3
<i>T. endoseriata</i>	20–60	11–18	5–6
<i>T. frenguelli</i> <sup>b</sup>	12–52? <sup>c</sup>	9–13	1–2
<i>T. poro-irregulata</i> <sup>b</sup>	21–30	10–15	4–6
<i>T. poroseriata</i>	14–38	11–16	1–2
<i>T. ritscheri</i>	42–72	12–16	3–4
<i>T. trifulta</i>	16–58	5–7	2

<sup>a</sup> Proc., processes.

<sup>b</sup> Mentioned in the text for comparison.

<sup>c</sup> ?, Data uncertain.

***Thalassiosira poroseriata*** (Ramsfjell) Hasle (Plate 12, Table 15)

**Basionym:** *Coscinosira poroseriata* Ramsfjell.

**References:** Ramsfjell, 1959, p. 175, Plates 1g and 2a; Hasle, 1972b, p. 544; Fryxell & Hasle, 1979b, p. 20, Figs. 31–36; Rivera, 1981, p. 117, Figs. 340–352; Johansen & Fryxell, 1985, p. 175, Figs. 10, 51, and 52.

**Girdle view:** Pervalvar axis often longer than cell diameter; valve face flat; mantle low and gently rounded. Several connecting threads about as long as perivalvar axis.

**Valve view:** Valves usually weakly silicified; areolation radial or fasciculated. One to eight central strutted processes on a straight, curved, or zigzag line; a central areola or annulus at the end of the line; labiate process away from margin almost in a line with the central processes.

**Distinctive feature:** Configuration of central processes.

**Remarks:** *Thalassiosira confusa* Makarova has central strutted processes in two rows, a labiate process closer to valve margin, and marginal processes more densely spaced than those of *T. poroseriata*.

***Thalassiosira trifulta*** G. Fryxell in Fryxell & Hasle (Plate 12, Table 15)

**Reference:** Fryxell & Hasle, 1979b, p. 16, Figs. 1–24.

**Girdle view:** Pervalvar axis shorter than cell diameter; valve face flat; mantle evenly rounded. No observations on chain formation.

**Valve view:** Valves often coarsely silicified; areolae in straight or slightly curved tangential rows. One to eight strutted processes in valve center in one or two lines; labiate process mostly closer to valve mantle than to valve center(?); eight or nine areolae from central process on large valves.

**Distinctive features:** Areola pattern; arrangement of central processes.

**Remarks:** The process pattern is difficult to see with LM because of the heavy silicification of the valves. *Thalassiosira frenguelli* Kozlova is similar to *T. trifulta* but it is more weakly silicified; the areolae are smaller, and the marginal strutted processes are more widely spaced. A possible conspecificity of *T. trifulta* and the Arctic *T. latimarginata* Makarova was discussed by Fryxell & Hasle (1979b) who did not find sufficient evidence to put them into synonymy at that time. This was done by Makarova (1988).

2c. +/- Modified ring of subcentral strutted processes.

***Thalassiosira endoseriata*** Hasle & G. Fryxell (Table 15)

**References:** Hasle & Fryxell, 1977b, p. 78, Figs. 45–49; Rivera, 1981, p. 68, Figs. 145–157.

**Girdle view:** Valve face flat; mantle low and rounded. No observations on chain formation.

**Valve view:** Areolation usually fasciculated. Four to 14 central strutted processes in an irregular ring, each process taking the place of an areola inside the middle row of a sector; labiate process about one-fourth the distance from margin toward center.

**Distinctive feature:** Location of central processes.

**Remarks:** *Thalassiosira proro-irregulata* Hasle & Heimdal (Hasle & Heimdal, 1970, p. 573) is another species with an irregular ring of subcentral strutted processes and fasciculated areolation. The internal parts of the processes are much longer and also built differently (SEM) from those of *T. endoseriata*, and the labiate process is farther away from the margin.

**Distribution:**

- T. confusa*—northern cold water region.
- T. endoseriata*—warm water region.
- T. frenguelli*, *T. ritscheri*, and *T. trifulta*—southern cold water region.
- T. poroseriata*—cosmopolitan.
- T. poro-irregulata*—Chilean coastal waters.

**Family Melosiraceae Kützing 1844**

Melosiraceae is characterized by:

- Strongly developed perivalvar axes.
- A marginal ring of labiate processes (sometimes reduced).
- Cells in chains.
- Primarily circular valve outline.

Simonsen (1979), who listed these characters, found the family circumscription unsatisfactory and suggested that Melosiraceae should be split into a number of families without doing so himself.

*Melosira* and *Stephanopyxis* share the characters mentioned previously; *Paralia* differs, however, by having a low mantle and a short perivalvar axis. Round et al. (1990) placed *Paralia* into the family Paraliaceae Crawford in the order Paraliales and Glezer et al. (1988) placed it into the Pseudopodosiraceae (Sheshukova) Glezer. *Stephanopyxis*, considered synonymous with *Pyxidicula* Ehrenberg, was placed into Pyxidiculaceae Nikolaev by Glezer et al., whereas Round et al. retained the name *Stephanopyxis* and placed it in the Stephanopyxidaceae Nikolaev.

Terminology specific to Melosiraceae

**Carina—Collar**—a circular membranous costa on the outer side of valve.

**Corona**—a ring of larger irregular spines at valve apex.

**Pseudoloculus**—a chamber formed on the outer side of the valve surface by expansion of the distal parts of anastomosing costae.

**KEY TO GENERA**

- 1a. Cells in chains close together . . . . . 2
- 1b. Cells in chains united by long external extensions of labiate processes . . . . . *Stephanopyxis*, p. 91

- 2a. Cells in chains united by mucilage pads, sometimes also by a corona consisting of larger irregular spines, valve mantle high and strongly curved. . . . . *Melosira*, p. 89
- 2b. Cells in chains united by interlocking ridges and grooves and marginal spines, valve mantle low and straight . . . . . *Paralia*, p. 89

**Genus *Melosira* C. A. Agardh 1824 (Plate 14, Table 16)**

**Type:** *Melosira nummuloides* C. A. Agardh.

**References:** Dickie, 1852, p. cxcvi; Van Heurck, 1880–1885, Plate 85, Figs. 3 and 4; Hustedt, 1930, pp. 231 and 233, Figs. 95 and 96; Hendey, 1964, p. 72, Plate 1, Fig. 1; Crawford, 1975; Syvertsen & Hasle, 1988.

*Melosira*, as typified by *M. nummuloides* (Crawford, 1975), is mainly a marine, nonplanktonic genus. The chloroplasts are numerous, small, and plate like lying in the peripheral cytoplasm.

**KEY TO SPECIES**

- 1a. Collar away from valve apex, corona present. . . . .  
 . . . . . *M. nummuloides* C. A. Agardh
- 1b. Collar close to valve apex, corona absent . . . . . *M. arctica*<sup>5</sup> Dickie

**Distribution:**

*M. arctica*—northern cold water region (also in the Baltic Sea and in the Oslofjord, Norway).

*M. nummuloides*—cosmopolitan?

**How to identify:** The two species may be identified as whole cells in water mounts. With EM preparations they are also distinguished by the structure of the striae and the labiate process pattern.

**Remarks:** Formation of resting spores (semiendogenous) is common in *M. arctica* and not known in *M. nummuloides*. *Melosira nummuloides* often appears in coastal plankton, detached from the substratum, and *M. arctica* and the Baltic form or variety (Syvertsen & Hasle, 1988) may be just as common attached to sea ice as in the plankton under or in the vicinity of the ice. According to the literature (e.g., Van Heurck, 1909; Manguin, 1960) *Melosira* is represented in the Antarctic as a tythropelagic species but never abundant. The taxonomy of the Antarctic *Melosira* species is confusing, and a thorough reexamination is needed.

**Genus *Paralia* Heiberg 1863**

**Type:** *Paralia marina* (W. Smith) Heiberg.

**Basionym:** *Orthosira marina* W. Smith.

<sup>5</sup> Synonym: *Melosira hyperborea* Grunow in Van Heurck, 1880–1885, Plate 85, Figs. 3 and 4.

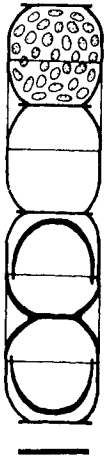

*Melosira arctica*



*Melosira nummuloides*

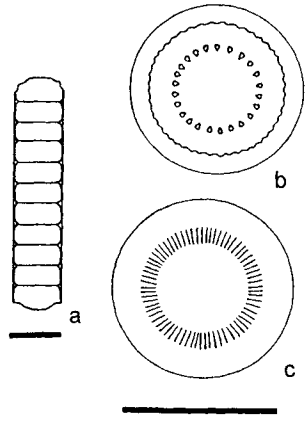

*Paralia sulcata*



*Stephanopyxis turris*

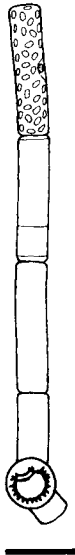

*Leptocylindrus danicus*

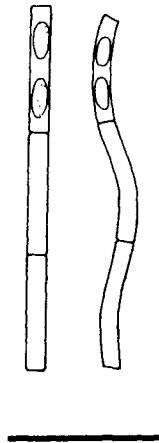

*Leptocylindrus minimus*

PLATE 14 *Melosira arctica*: chain with semiendogenous resting spores. *Melosira nummuloides*: chain, collars evident. *Paralia sulcata*: (a) chain in girdle view; (b) intercalary valve; (c) separation valve. *Stephanopyxis turris*: chain with two semiendogenous resting spores. *Leptocylindrus danicus*: chain, cells with numerous chloroplasts, one cell with resting spore. *Leptocylindrus minimus*: two chains, one slightly helical, two chloroplasts. Scale bars = 20  $\mu$ m.

TABLE 16 Morphometric Data of  
*Melosira* spp.

Species	Valve diameter ( $\mu\text{m}$ )	Valve height ( $\mu\text{m}$ )
<i>M. arctica</i>	10–40	11–17
<i>M. nummuloides</i>	10–40	10–14

**Correct name:** *Paralia sulcata* (Ehrenberg) Cleve (*vide* Crawford, 1979, p. 209).

**References:** Crawford, 1979; Crawford, 1988, p. 422; Crawford et al., 1990.

***Paralia sulcata*** (Ehrenberg) Cleve (Plate 14)

**Basionym:** *Gaillonella sulcata* Ehrenberg.

**Synonym:** *Melosira sulcata* (Ehrenberg) Kützing.

**References:** Ehrenberg, 1838, p. 170, Plate 21, Fig. 5; Ehrenberg, 1841a, p. 152, Plate 3, Fig. 5; Kützing, 1844, p. 55, Plate 2, Fig. 7; Cleve, 1873b, p. 7; Hustedt, 1930, p. 276, Fig. 119; Cupp, 1943, p. 39, Fig. 2; Hendey, 1964, p. 73, Plate 23, Fig. 5; Crawford, 1979.

**Girdle view:** Cell wall extremely heavily silicified. Cells more wide than long. Valve face flattened. Chloroplasts several per cell; small discoid.

**Valve view:** Separation valves at ends of chains without marginal spines and reduced ridges (heterovalvy).

**Morphometric data:** Pervalvar axis 3–45  $\mu\text{m}$ ; diameter 8–130  $\mu\text{m}$ .

**Distribution:** *Paralia sulcata* is a bottom form but fairly common in coastal plankton, probably cosmopolitan.

**How to identify:** *Paralia sulcata* may be identified as whole cells in water mounts and as cleaned material on permanent mounts either as sibling or single valves in girdle as well as valve views. The difference in structure of the separation and intercalary valves has to be taken into consideration. If not, this heterovalvy may cause confusion.

**Genus *Stephanopyxis*** (Ehrenberg) Ehrenberg 1845 (Plate 14, Table 17)

**Type:** *Pyxidicula aculeata* Ehrenberg.

**References:** Ehrenberg, 1844c, p. 264; Greville, in Gregory, 1857, pp. 538 and 540, Plate 14, Fig. 109; Pritchard, 1861, p. 826, Plate 4, Fig. 74; Greville, 1865a, p. 2, Plate 1, Fig. 9; Grunow, 1884, p. 90; Gran & Yendo, 1914, p. 27, Fig. 16; Hustedt, 1930, p. 302, Figs. 140 and 147; Cupp, 1943, p. 40, Figs. 3–5; Hasle, 1973b, Figs. 91–112; Round, 1973, Figs. 1–14; Glezer et al., 1988, pp. 43 and 46, text Fig. 2: 3–7, Plate 25, Figs. 8



TABLE 17 Morphometric Data of *Stephanopyxis* spp.

Species	Diameter (µm)	Valve areolae in 10 µm	Mantle areolae in 10 µm
<i>S. nipponica</i>	24–36	— <sup>a</sup>	5–6
<i>S. palmeriana</i>	27–71	1.5–2.5	5–5.5
<i>S. turris</i>	36–57	3.5–5	3.5–5

<sup>a</sup> —, No data.

and 9, Plate 27, Figs. 1–11, Plate 28, Figs. 1–10; Takano, 1990, pp. 240–241.

*Stephanopyxis* has usually been distinguished from *Pyxidicula* by its long siliceous external extensions of labiate processes, uniting cells in chains. Strelnikova & Nikolaev (1986) did not accept this distinction and made the point that this type of linking is also found in *Pyxidicula*. The two genera are similar in valve structure and, despite the information in the older literature, they have girdles consisting of many bands (for *Pyxidicula mediterranea*, Hasle, unpublished observation made on a von Stosch culture). For the sake of convenience the name *Stephanopyxis* is retained for the planktonic diatoms dealt with in this chapter.

Electron microscopy revealed external valve wall structures which have been interpreted in various ways and which have a certain similarity to pseudoloculi (Hasle, 1973b, p. 131; Round et al., 1990, p. 158). Here they are called loculate areolae with wide foramina for the sake of simplicity.

Generic characters:

- Valve mantle high, more or less curved.
- Valve wall with large hexagonal areolae with large external foramina.
- Resting spores present (semiendogenous).

KEY TO SPECIES

- 1a. External structures of labiate processes joined midway between cells in chains . . . . . 2
- 1b. Not so . . . . . *S. nipponica* Gran & Yendo
- 2a. Areolae of same size on whole valve . . . . . *S. turris*<sup>6</sup> (Arnott in Greville) Ralfs in Pritchard
- 2b. Areolae larger on valve face than on valve mantle . . . . . *S. palmeriana*<sup>6</sup> (Greville) Grunow

<sup>6</sup> Basionyms: *Creswellia turris* Arnott in Greville; *Creswellia palmeriana* Greville, respectively.

**Distribution:**

*S. nipponica*—temperate to northern cold water region (Cupp, 1943).

*S. palmeriana*—temperate to warm water region (Cupp, 1943).

*S. turris*—temperate to warm water region (?).

**How to identify:** The specific distinctive characters are readily seen in water mounts.

**Remarks:** Resting spores are known for *S. turris* and *S. palmeriana*.

**Family Leptocylindraceae Lebour 1930**

Simonsen (1979, p. 17) tentatively considered *Leptocylindrus* to belong to the family Melosiraceae, whereas Round et al. (1990) retained the family Leptocylindraceae and suggested a new order, Leptocylindrales, in the subclass Chaetocerotophycidae. Glezer et al. (1988) classified the genus under Pyxilla-ceae Schütt in the order Rhizosoleniales.

Lebour’s (1930, p. 75) family description is as follows: “Cells cylindrical, living singly or united in chains by the flat valve faces. Many collar-like intercalary bands.” This diagnosis has to be emended, independent of whether Leptocylindraceae is regarded as monotypic, as done by Round et al. (1990), or as to encompass two genera as suggested in this chapter. The character to be added is: the presence of a marginal ring of spines, small, flap like, or triangular in *Leptocylindrus* and long and unique in shape in *Corethron*.

**Genus *Leptocylindrus* Cleve 1889 (Plates 14 and 15, Table 18)**

**Type:** *Leptocylindrus danicus* Cleve.

**References:** Cleve, 1889, p. 54; Peragallo, 1888, p. 81, Plate 6, Fig. 45; Gran, 1915, p. 72, Fig. 5; Hustedt, 1930, pp. 556–557, Figs. 317–321; Cupp, 1943, p. 77, Fig. 38; French & Hargraves, 1986; Fryxell, 1989, p. 4, Figs. 1–5; Takano, 1990, pp. 236–237; Hargraves, 1990; Delgado & Fortuño, 1991, Plate 61, Figs. c and d.

**Generic characters:**

Tight chains by abutting valve faces.

Cells cylindrical.

Numerous half bands, trapezoidal in outline (TEM).

Central parts of valves slightly convex or concave.

Short flap-like spines on the border between valve face and mantle.

Resting spores inside an auxospore-like sphere, distinctly different from vegetative cells.

**KEY TO SPECIES**

- 1a. Cell wall weakly silicified, neither valve nor girdle structure resolved with LM . . . . . 2

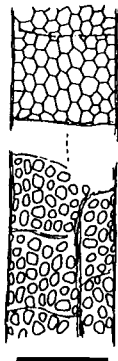
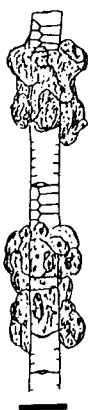

*Leptocylindrus mediterraneus*

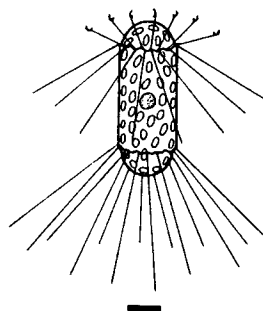

*Corethron criophilum*

*Coscinodiscus*

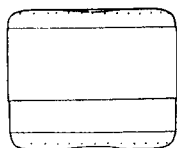

*C. argus*

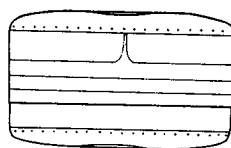

*C. asteromphalus*

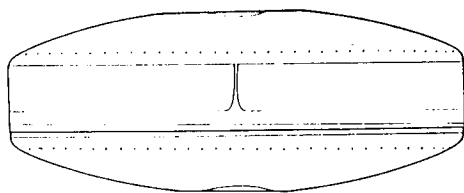

*C. centralis*

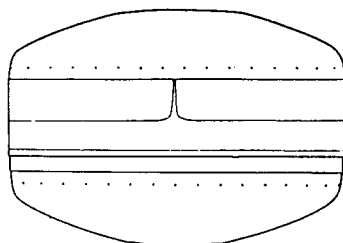

*C. alboranii*

PLATE 15. *Leptocylindrus mediterraneus*: (a) chain with epiphyte; (b) detail of girdle. Scale bar = 10  $\mu\text{m}$ . After Cupp (1943). *Corethron criophilum*: single cell with characteristic spines. Scale bar = 10  $\mu\text{m}$ . *Coscinodiscus argus*: Girdle view, processes away from margin. Scale bar = 20  $\mu\text{m}$ . *Coscinodiscus asteromphalus*: girdle view, processes close to margin. Scale bar = 20  $\mu\text{m}$ . *Coscinodiscus centralis*: girdle view, evenly vaulted valves with a central depression. Scale bar = 20  $\mu\text{m}$ . *Coscinodiscus alboranii*: girdle view, steep mantle and evenly vaulted valve face. Scale bar = 20  $\mu\text{m}$ .

TABLE 18 Morphometric Data of  
*Leptocylindrus* spp.

Species	Diameter ( $\mu\text{m}$ )	Bands in 10 $\mu\text{m}$
<i>L. danicus</i>	5–16	— <sup>a</sup>
<i>L. mediterraneus</i>	7–35	1–5
<i>L. minimus</i>	1.5–4.5	—

<sup>a</sup> —, No data.

- 1b. Cell wall coarsely structured . . . *L. mediterraneus*<sup>7</sup> (H. Peragallo) Hasle  
 2a Two (seldom one) elongate chloroplasts, chains sometimes slightly undu-  
 lated . . . . . *L. minimus* Gran  
 2b. Numerous small rounded chloroplasts . . . . . *L. danicus* Cleve

**Distribution:**

*L. danicus*—cosmopolitan—absent or scarce in the subantarctic/Antarctic (recorded from the Drake Passage Rivera, 1983); recorded as dominant species at 81°43'N (Heimdal, 1983); one of the dominant summer diatoms in Norwegian fjords.

*L. mediterraneus*—cosmopolitan—recorded from the Antarctic to the Arctic, seldom or never as a dominant species (Hasle, 1976a); scarce in the Arctic.

*L. minimus*—cosmopolitan—apparently absent from the Subantarctic/Antarctic (Hargraves, 1990).

**How to identify:** All three species may be identified in water mounts, *L. mediterraneus* especially by the presence of the epiphytic flagellate *Rhizomonas setigera* (Pavillard) Patterson, Nygaard, Steinberg, & Turley (= *Solenicola setigera* in Fryxell, 1989, Figs. 1–5). Single valves of *L. mediterraneus* mounted in a medium of a high refractive index are recognized by its coarse, open structure (Hasle, 1976a, Fig. 34), whereas those of *L. danicus* may be recognized under the best optical conditions by the small spines in the bordering zone between valve face and mantle and the sometimes more coarsely structured valve center.

**Remarks:** It should be noted that of two adjacent *L. danicus* valves in a chain one is slightly convex and the other concave, and neither are exactly flattened. *Leptocylindrus minimus* and *L. danicus* are distinguished not only by size and chloroplasts but also by the shape of the resting spores. The *L. minimus* resting spore is globular with a cylindrical neck, whereas that of

<sup>7</sup> Basionym: *Dactyliosolen mediterraneus* (H. Peragallo) H. Peragallo (see Hasle, 1975).

*L. danicus* consists of two unequal valves (Hargraves, 1990). *Leptocylindeus mediterraneus* is seldom found with chloroplasts and the cell wall has a double-layered structure (Hasle, 1975). Its taxonomic position is therefore questionable. *Leptocylindeus* includes two taxa in addition to those dealt with here, viz. *L. danicus* var. *adriaticus* (Schröder) Schiller from the Adriatic Sea and *L. curvatulus* Skvortzov from the Sea of Japan. The main character of the former is the ratio between perivalvar axis and diameter, which is greater than that in *L. danicus*, whereas the latter is distinguished by undulated chains. Their identity as separate taxa remains to be proven.

**Genus *Corethron* Castracane 1886 (Plate 15, Table 19)**

**Lectotype:** *Corethron criophilum* Castracane (*vide* Boyer, 1927, p.114).

**References:** Castracane, 1886, p. 85, Plate 21, Figs. 3–6, 12, 14, and 15; Karsten, 1905, p. 100, Plates 12–14; Hendey, 1964, p. 144, Plate 7, Fig. 4; Fryxell & Hasle, 1971; Fryxell, 1989, p. 9, Figs. 27–32; Thomas & Bonham, 1990.

*Corethron* was placed in Melosiraceae by Simonsen (1979) and in Chaetocerotaceae by Glezer et al. (1988), whereas Round et al. (1990) retained the family Corethraceae Lebour 1930 and introduced Corethrophycidae and Corethrales as a new subclass and a new order, respectively. The position in Chaetocerotaceae probably reflects an emphasis on the presence of long siliceous outgrowths, called spines for lack of a better term, from the border of the valve face. The unique shape of the marginal spines may be a reasonable justification for establishing a separate subclass and order for the genus.

Hendey (1937) concluded that *Corethron* was a monotypic genus, with *C. criophilum* as the only species, but appeared in different phases. Thomas & Bonham (1990) claimed the existence of two *Corethron* species in the Antarctic.

**Generic characters:**

- Cells cylindrical with more or less dome-shaped valves.
- Girdle composed of many bands.
- Valves with marginal long (barbed) and short hooked (clawed) spines.
- Chloroplasts numerous rounded or oval bodies.

**KEY TO SPECIES (mainly after Thomas & Bonham, 1990)**

- 1a. Cells solitary, robust, heterovalvate, valves with both hooked and long spines or long spines only, bands open, ligulate . . . . . *C. criophilum* Castracane
- 1b. Cells usually in colonies, weakly silicified, only end cells of colonies heterovalvate, intercalary valves with short spines interlocking sibling valves, cingulum composed of half bands . . . . . *C. inerme* Karsten

TABLE 19 Morphometric Data of *Corethron* spp. (Hendey, 1937)

Species	Pervalvar axis ( $\mu\text{m}$ )	Diameter ( $\mu\text{m}$ )
<i>C. criophilum</i>	20–200	5–20
<i>C. inerme</i>	40–350	30–40

**Distribution:** If Hendey's concept of *Corethron* as a monotypic genus is followed, *C. criophilum* is a cosmopolitan species recorded as far north as ca. 80°N (Heimdal, 1983) and occurring in its greatest abundances in Antarctic waters (Fryxell & Hasle, 1971). As far as known, *C. inerme* has not been recorded outside the Antarctic.

**How to identify:** The species may be identified to genus from specimens in water mounts either of whole cells or of a single valve.

**Remarks:** The structure of the spines was described by Karsten (1905) and verified with EM by Fryxell & Hasle (1971).

#### Family Coscinodiscaceae Kützing 1844

*Palmeria* was classified under this family by Simonsen (1979) as well as by Round et al. (1990). *Ethmodiscus* was tentatively placed in Stictodiscoideae Simonsen, subfamily in Biddulphiaceae, by Simonsen (1979), in Ethmodiscaceae Round in the order Ethmodiscales Round by Round et al. (1990), and in Coscinodiscaceae by Glezer et al. (1988).

The genera dealt with here are characterized by:

Solitary cells (exception, *C. bouvet*).

No external tubes or processes.

Marginal labiate processes, sometimes in more than one ring [may be absent in *Ethmodiscus* (Rivera et al., 1989)].

Labiate processes are sometimes also between valve center and margin, irregularly positioned if present in central part of valve.

Labiate processes usually of two types (shape and/or size).

Areolae loculate; cribra external; foramina internal (SEM).

#### KEY TO GENERA

- 1a. Valves circular . . . . . 2  
 1b. Valves semicircular . . . . . *Palmeria*, p. 111

2a. Pervalvar axis **high**, cell diameter up to 2 mm . . . *Ethmodiscus*, p. 110

2b. Pervalvar axis and diameter smaller . . . . . *Coscinodiscus*, p. 98

**Genus *Coscinodiscus*** Ehrenberg 1839 emend. Hasle & Sims 1986

**Lectotype:** *Coscinodiscus argus* Ehrenberg (proposed by Ross & Sims, 1973, conservation proposed by Fryxell, 1978b).

**References:** Ehrenberg, 1839, p. 128; Fryxell, 1978b, p. 122; Hasle & Sims, 1986a, p. 316.

*Coscinodiscus* is usually regarded as one of the largest marine planktonic diatom genera [400–500 validly described taxa (VanLandingham, 1968)]. A great number of the most frequently recorded *Coscinodiscus* species have been transferred to *Thalassiosira*, *Azpeitia*, and *Actinocyclus*, or to new genera as illustrated by the fact that of the approximately 20 *Coscinodiscus* species recorded in the Arctic literature between 1853 and 1911 only 4 are now regarded as belonging to the genus.

The *Coscinodiscus* species dealt with in this chapter are frequently recorded in the literature and/or they have been critically examined with LM and EM. Some of them are readily distinguished by special, pronounced morphological features, whereas others are easily confused. Our interpretation of the species is based on the often incomplete original diagnoses, the descriptions in Hustedt (1930), as well as recent LM and EM investigations referred to under the various species. It should be noted that the data on cell diameter of these species vary considerably in the literature. We have tried to use a compilation of data, and the sources are not given specifically in all cases.

All the species dealt with here have (see Fig. 13):

Radial areola pattern.

Two larger marginal labiate processes (macro-rimoportulae).

Marginal ring of smaller labiate processes.

Numerous, usually disc-shaped, chloroplasts.

Comments on terminology (Figs. 6a–6e, 7c–7g, 10, and 13)

The radial rows of areolae (striae) may be grouped into more or less distinct bundles (fasciculation), and/or spiraling rows (decussating arcs) may be present (Figs. 6a–6e and 10b and 10c). Radial rows inserted from the margin (inserted striae, incomplete striae) are necessarily present in this type of areola pattern (Figs. 6d and 6e and 13). The bundles are separated by more or less distinct unperforated radial areas (wide interstriae, hyaline spaces, hyaline lines), on valve face, as well as on valve mantle (Plate 16, *C. concinnus*; Plate 17, *C. walesii*). Valve center is usually occupied by either a hyaline (nonareolate) area or by a rosette of larger areolae (Figs. 6b, 7c and 7d, and 13). The structure of this central area may vary parallel to the cell diminution by the vegetative multiplication (Schmid, 1990).

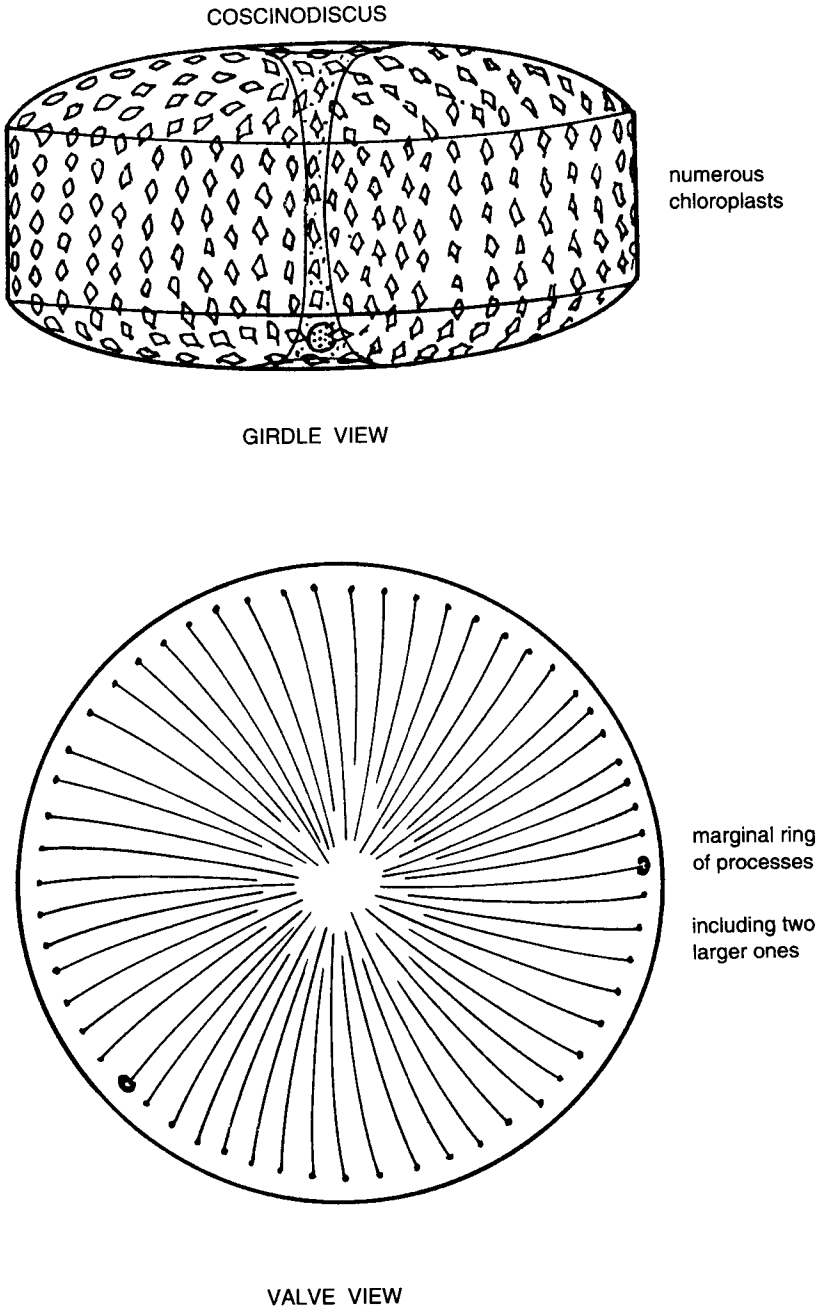
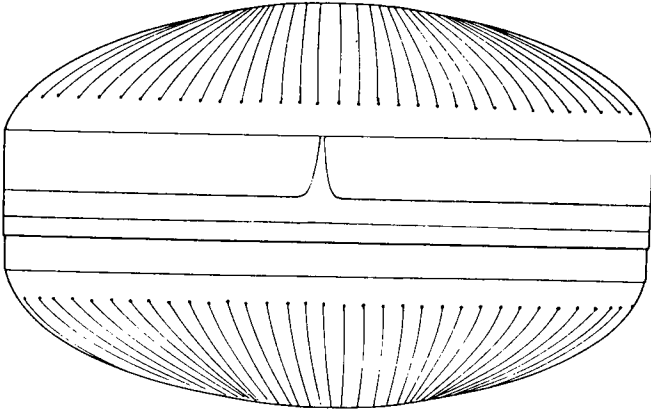

FIGURE 13 Schematic illustration of *Coscinodiscus* sp. showing numerous chloroplasts, marginal ring of smaller labiate processes and the two larger processes (macrorimpoportulae).



*Coscinodiscus*



*C. concinnus*

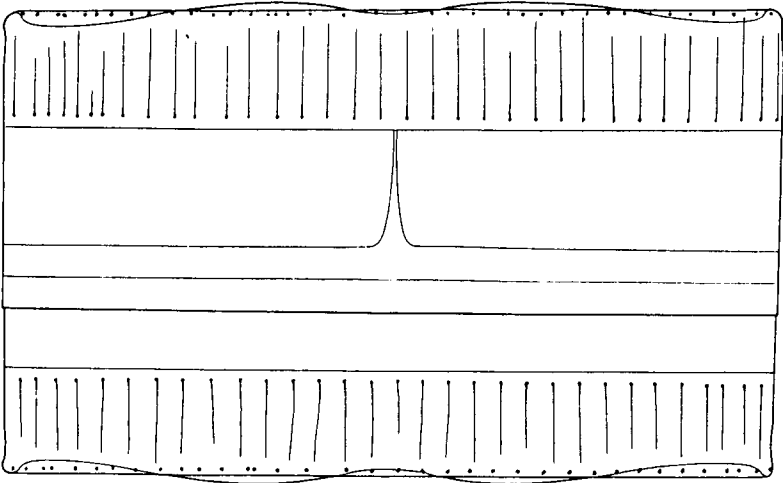

*C. wailesii*

**PLATE 16** *Coscinodiscus concinnus*: girdle view. Broader interstriae distinct, one marginal ring of processes at ends of interstriae. *Coscinodiscus wailesii*: girdle view. High, steep valve mantle with two rings of labiate processes, one ring in the junction zone between valve face and mantle, and one ring close to valve margin at end of wide interstriae. Scale bar = 20  $\mu\text{m}$ .

The two larger processes (Figs. 7e–7g) are usually observed with LM, in the larger species in water mounts, and in most species in acid cleaned material mounted in a medium of a high refractive index (Figs. 6a and 6c and 13). When noticed in the past, they were termed “unsymmetrische Prozesse” (Hustedt, 1930), or “asymmetrical processes or apiculi” (Cupp, 1943; Hende, 1964). In some species the internal part and the shape of the processes are not revealed with LM; their position may be revealed, however, by indentations of the valve margin. When discernible with LM, the smaller labiate processes (Figs. 6a and 6c and 13) were termed in the past “Randdornen” (Hustedt, 1930) or “spinulae” (Cupp, 1943; Hende, 1964). Smaller labiate processes may be present in a second marginal ring or on the valve face, usually associated with wide interstriae, or at the points of origin of incomplete striae.

“Interstitialmaschen—interstitial meshes” (Hustedt, 1930; Cupp, 1943) are located at the points of origin of incomplete striae and are identical with labiate processes, small pentagonal areolae or larger adjacent areolae, or unperforated areas.

Characters showing differences between species (partly based on Fryxell & Ashworth, 1988):

Cell shape in girdle view.

Cell diameter.

Valve shape.

Areolae (size) in 10  $\mu\text{m}$  near center and peripheral.

Height of mantle, measured as number of areolae.

Areola pattern on valve face.

Central area, shape (rosette of larger areolae or nonareolated = hyaline).

The presence/absence of hyaline lines (interspaces, wide interstriae).

Shape of the larger processes.

Distance between the larger processes.

Distance between the smaller marginal processes (measured as number of areolae).

The presence or absence of processes on valve face.

Chloroplast outline.

See Schmid (1990) for further details on variation of some of these characters through the life cycle.

The species dealt with in this chapter are grouped according to the shape of the frustules in girdle view with the same qualifications as made for *Thalassiosira* spp.

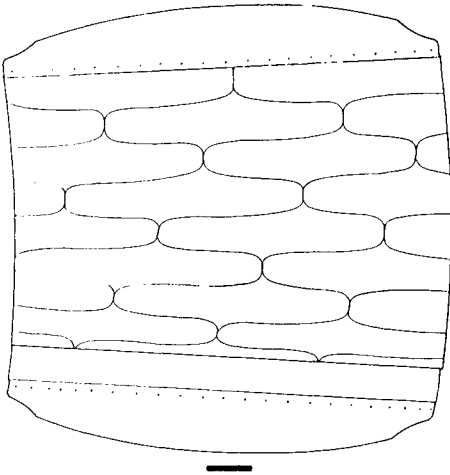
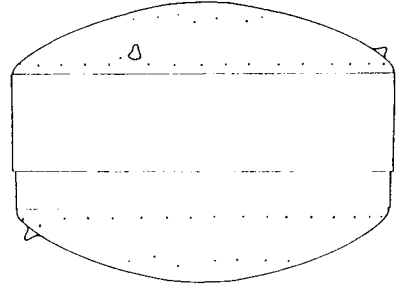
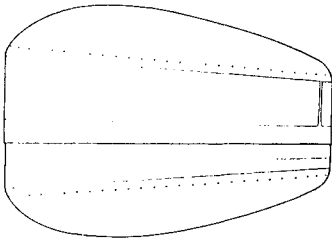
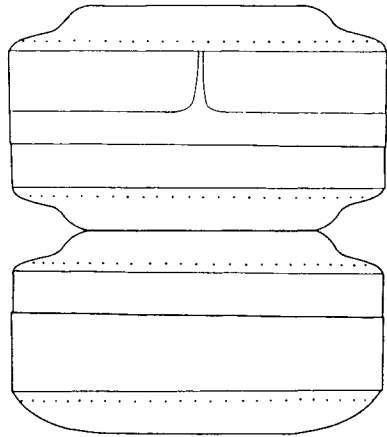
Coscinodiscus*C. concinniformis**C. jonesianus**C. granii**C. bouvet*

**PLATE 17** *Coscinodiscus concinniformis*: girdle view with several columns of segments. *Coscinodiscus jonesianus*: girdle view with evident outer parts of larger labiate processes. *Coscinodiscus granii*: girdle view, showing valve mantle and bands of uneven width. *Coscinodiscus bouvet*: girdle view, short chain. Scale bar = 20  $\mu\text{m}$ .

- A. Frustules discoid to cylindrical: *C. alboranii*, *C. argus*, *C. asteromphalus*, *C. centralis*, *C. concinniformis*, *C. concinnus*, *C. jonesianus*, *C. marginatus*, and *C. wailesii* (Tables 20a and 20b).

- B. Frustules coin shaped: *C. radiatus* (Tables 20a and 20b).  
 C. Frustules with a stepped elevated valve face: *C. bouvet* (Tables 20a and 20b).  
 D. Frustules wedge shaped: *C. granii* (Tables 20a and 20b).
- A. Frustules discoid.

***Coscinodiscus argus* Ehrenberg (Plate 15, Tables 20a and 20b)**

**References:** Ehrenberg, 1839, p. 129; Ehrenberg, 1841a, p. 145; Ehrenberg, 1854, Plate 21, Fig. 2, Plate 22, Fig. 5; Hustedt, 1930, p. 422, Fig. 226; Hasle & Sims, 1986a, Figs. 1–7, 33, and 34.

**Girdle view:** Valve face flat or slightly depressed in the center; rounded margins; valve mantle steep and high.

**Valve view:** Small central hyaline area just discernible with LM; areolae in the center differ slightly from the others in shape, but not in size.

Decussating arcs present but not prominent. Hyaline lines (ribs) visible internally (SEM) but not perceived with LM, neither are the marginal processes. Foramina and cribra just discernible with LM.

**Distinctive features:** Areolae increase in size from the center of the valve toward the middle of the radius, then decrease in size toward the margin.

TABLE 20a Morphometric Data of *Coscinodiscus* spp.

Species	Diameter (µm)	Valve areolae in 10 µm	No. of bands/theca	Valvocopula width (µm)
Group A				
<i>C. alboranii</i>	38–215	7–9.5	2	17 ?
<i>C. argus</i>	31–110	2–6	—	—
<i>C. asteromphalus</i>	80–400	3–5	4	13–14
<i>C. centralis</i>	100–300	4–6	3	20–24
<i>C. concinniformis</i>	150–500	ca. 10	Segmented	—
<i>C. concinnus</i>	110–500	7–9	5 ?	20–26
<i>C. jonesianus</i>	140–280	5–9	—	—
<i>C. marginatus</i>	35–200	1–4	—	12–24
<i>C. wailesii</i>	280–500 <sup>a</sup>	5–6	3	44–60
Group B				
<i>C. radiatus</i>	30–180	2–9	3	—
Group C				
<i>C. bouvet</i>	100–290	6–10	2	23–28
Group D				
<i>C. granii</i>	40–200	8–11	2 ?	17–20

Note. ?, Data uncertain; —, no data available.

<sup>a</sup> 550–50 µm under laboratory conditions (Schmid, 1990, p. 109).

TABLE 20b Processes in *Coscinodiscus* spp.

Species	Margin rings	Areolae from margin	Areolae apart <sup>a</sup>	Scattered on valve face
Group A				
<i>C. alboranii</i>	1 + 1	4 + 2-3	7-16	-
<i>C. argus</i>	1	3-4	1-3	-
<i>C. asteromphalus</i>	1	1-2	3-6	-
<i>C. centralis</i>	1	3-4	2-5	-
<i>C. concinnus</i>	1	4-9	3-9	-
<i>C. concinniformis</i>	1	2 ?	9-11	+
<i>C. jonesianus</i>	1	2 ?	10-20	-
<i>C. marginatus</i>	1	2 ?	1-2	-
<i>C. walesii</i>	2	2-3**	2-10	+
Group B				
<i>C. radiatus</i>	1	1-2	4-5	+
Group C				
<i>C. bouvet</i>	1	2-3	3-4	+
Group D				
<i>C. granii</i>	1	2-4	5-8	-

Note. +, Present; -, absent; ?, data uncertain.

<sup>a</sup> Macrolabiate process 2-3 areolae from margin.

<sup>b</sup> The other ring at the junction between valve face and mantle.

### *Coscinodiscus asteromphalus* Ehrenberg (Plate 15, Tables 20a and 20b)

**References:** Ehrenberg, 1844a, p. 77; Ehrenberg, 1854, Plate 18, Fig. 45; Hustedt, 1930, p. 452, Figs. 250 and 251; Hasle & Lange, 1992, p. 42, Figs. 1-14.

**Girdle view:** Cells discoid with slightly convex valves; valve center depressed and valve mantle gently sloping. Numerous large rounded plate-like chloroplasts.

**Valve view:** Central rosette of somewhat larger areolae present, usually not prominent. Decussating arcs fairly distinct. No hyaline lines. Cribra just visible with LM. Ring of processes close to valve margin visible with LM. Interstitial meshes (probably smaller areolae) present at the points of origin of short incomplete striae. Larger labiate processes about 120-135° apart, comparatively small.

**Distinctive features:** Compared to *C. argus* and *C. centralis*, which are the most similar species, *C. asteromphalus* has the ring of processes closer to the margin.

***Coscinodiscus centralis* Ehrenberg (Figs. 6a–6c, Plate 15, Tables 20a and 20b)**

**References:** Ehrenberg, 1844a, p. 78; Ehrenberg, 1854, Plate 18, Fig. 39, Plate 21, Fig. 3, Plate 22, Fig. 1; Hustedt, 1930, p. 444, Fig. 243; Semina & Sergeeva, 1980; Hasle & Lange, 1992, p. 45, Figs. 15–30.

**Girdle view:** Cells discoid; valves gently convex. Numerous small plate-like chloroplasts.

**Valve view:** Distinct rosette of large areolae (Fig. 6b), sometimes with a small hyaline area in the middle. Areola rows grouped into narrow bundles bordered by hyaline lines, distinct in weakly silicified valves and indistinct in coarsely silicified valves. Decussating arcs in the central part of the valve. Hyaline lines associated with labiate processes at the valve margin. Interstitial meshes present, identical with the pentagonal areola at the point of origin of an incomplete stria or an adjacent larger areola. Cribra resolved with LM (Fig. 6b), consisting of one central pore and a marginal ring of pores. Marginal processes readily resolved with LM; the smaller processes are long necked and slightly curved, the two larger processes, ca. 135° apart, have two “horns” (Fig. 6c).

**Distinctive features:** Distinguished from *C. argus* and *C. asteromphalus* by the central areolae distinctly set off from the much smaller surrounding areolae, and the cribra and processes readily resolved with LM; and distinguished from *C. concinnus* by the shorter perivalvar axis, the more coarsely structured valves, and the marginal processes closer to the valve margin (Plates 15 and 16).

***Coscinodiscus concinnus* Wm. Smith (Plate 16, Tables 20a and 20b)**

**References:** Smith, 1856, p. 85; Hustedt, 1930, p. 442, Figs. 241 and 242; Boalch, 1971, Plate 2; Brooks, 1975; Hasle & Lange, 1992, p. 50, Figs. 31–48.

**Girdle view:** Cells thin walled; valves convex. Numerous small chloroplasts, fimbriate in outline, markedly H shaped when dividing. Marginal processes discernible in water mounts.

**Valve view:** Central rosette large with a star-shaped hyaline area in the middle. The size of the hyaline area and the development of areola walls variable. Areola rows in bundles bordered by distinct hyaline lines running from marginal labiate processes toward valve center (Plate 16). Interstitial meshes, sometimes visible, probably identical with the pentagonal areola at the point of origin of each incomplete stria. The cribra barely seen with LM. Two larger marginal processes, ca. 135° apart, with raised parts as well as the smaller marginal processes, readily seen with LM.

**Distinctive features:** Greater distance between valve margin and processes than in *C. centralis*, *C. concinniformis*, and *C. wailiesii*; species with which *C. concinnus* may be confused.

***Coscinodiscus wailesii*** Gran & Angst (Plate 16, Tables 20a and 20b)

**References:** Gran & Angst, 1931, p. 448, Fig. 26; Schmid & Volcani, 1983; Takano, 1990, pp. 250–251; Schmid, 1990; Hasle & Lange, 1992, p. 55, Figs. 49–62.

**Girdle view:** Cells low to tall cylindrical, often as high as wide, and rectangular in outline at a certain focus. Valves flattened with a concentric depression near the steep high mantle. Numerous chloroplasts irregular in outline. Marginal processes discernible in water mounts.

**Valve view:** Prominent central hyaline (unperforated) area; wide interstriae (hyaline lines) radiating from the central area. Irregular fasciculation formed, partly by wider interstriae, partly by distinct incomplete striae, originating near the valve center at a labiate process or a small hyaline area (area of solid silica). Cribra visible with LM. One ring of smaller processes in the junction zone between valve face and mantle, and one ring including two larger processes, 120–180° apart, close to the valve margin. Processes in the first ring more densely spaced than those in the second ring. Hyaline lines more conspicuous and regular on valve mantle than on valve face, associated with processes.

**Distinctive features:** High, steep mantle with hyaline lines and two marginal rings of processes.

***Coscinodiscus concinniformis*** Simonsen (Plate 17, Tables 20a and 20b)

**References:** Simonsen, 1974, p. 14, Plates 10 and 11; von Stosch, 1986, p. 303, Figs. 5 and 6.

**Girdle view:** Cells cylindrical, as high as wide or higher. Girdle consisting of several columns of segments, curved with the two valves inclined toward each other. Valves uniformly and moderately convex; mantle extremely low. Weakly silicified. Numerous small chloroplasts.

**Valve view:** Prominent central hyaline (unperforated) area from which wide interstriae (hyaline lines) bordering bundles of radial areola rows radiate and partly branch. Labiate processes at the points of origin of incomplete striae. One ring of processes close to the valve margin, each process at the end of a hyaline line. Processes discernible with LM. The two larger processes ca. 125° apart.

**Distinctive features:** Distinguished in valve view from *C. wailesii* by one ring of processes on valve face and from *C. concinnus* by scattered processes on valve face and the ring of processes closer to valve margin.

***Coscinodiscus alboranii*** Pavillard (Plate 15, Tables 20a and 20b)

**References:** Pavillard, 1925, p. 13, Fig. 16; von Stosch, 1986, pp. 295–303.

**Girdle view:** Cells cylindrical, up to 1.5 times as long as wide. Valves convex, flattened in the center, and nearly semiglobular in small cells. Four lobed or oval chloroplasts. Cell wall extremely weakly silicified.

**Valve view:** (structures seen in air mounts with phase contrast) A circular central area without areolae, distinct hyaline lines between the central area and one marginal ring of processes. Two larger processes, ca. 125° apart, closer to the margin than the smaller processes. Valve face with two types of areolae, the rarer of which appears darker in phase contrast. Valve margin usually with a special type of areolae, endochiastic areolae, appearing as dark circlelets with an internal structure similar to a cross.

**Distinctive features:** Two types of valve face areolae; endochiastic areolae on valve mantle.

***Coscinodiscus jonesianus*** (Greville) Ostenfeld (Plate 17, Tables 20a and 20b)

**Basionym:** *Eupodiscus jonesianus* Greville.

**References:** Greville, 1862, p. 22, Plate 2, Fig. 3; Ostenfeld, 1915, p. 13, Fig. 7; Hustedt, 1930, p. 438, Fig. 239; Hendey, 1964, p. 79; Makarova, 1985, p. 52, Plate 2; Takano, 1990, pp. 246–247.

**Girdle view:** Cells about as high as wide. Valves convex, slightly concave in the center.

**Valve view:** Central rosette of larger areolae more or less distinct. Areolae in radial and spiraling rows. Cribra visible with LM. At about half radius an irregular ring of interstitial meshes (probably labiate processes). One marginal ring of processes, visible with LM, with hyaline lines bordered by one row of slightly larger areolae on either side toward the valve center. Inside the marginal ring two larger processes with prominent external areolated protuberances, ca. 100° apart.

**Distinctive features:** Large external protuberances of the two larger marginal processes.

***Coscinodiscus marginatus*** Ehrenberg (Plate 18, Tables 20a and 20b)

**References:** Ehrenberg, 1844a, p. 78; Ehrenberg, 1854, Plate 18, Fig. 44, Plate 33/12, Fig. 13, Plate 38b/22, Fig. 8; Hustedt, 1930, p. 416, Fig. 223; Hendey, 1964, p. 78, Plate 22, Fig. 2; Sancetta, 1987, p. 231, Plate 1, Figs. 1–13.

**Girdle view:** Cells discoid, thick walled. Valves flat or nearly so with steeply sloping or straight mantle. Several small rounded chloroplasts.

**Valve view:** No central rosette. Coarse areolae in irregular radial rows. Cribra discernible with LM, processes not.

**Distinctive feature:** The coarse areolation.

B. Frustules coin shaped.

***Coscinodiscus radiatus*** Ehrenberg (Figs. 6d and 6e, Plate 18, Tables 20a and 20b)

**References:** Ehrenberg, 1841a, p. 148, Plate 3, Fig. 1; Hustedt, 1930, p. 420, Fig. 225; Hendey, 1964, p. 76, Plate 22, Fig. 7; Hasle & Sims, 1986a,



*Coscinodiscus*



*C. radiatus*

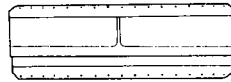

*C. marginatus*

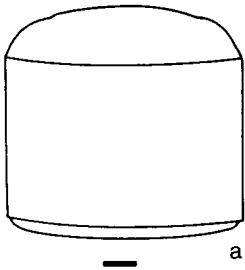

a

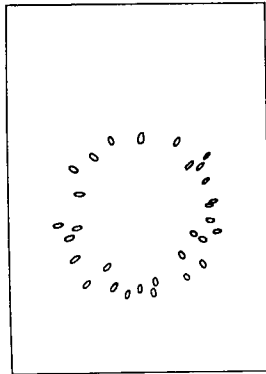

b

*Ethmodiscus gazellae*

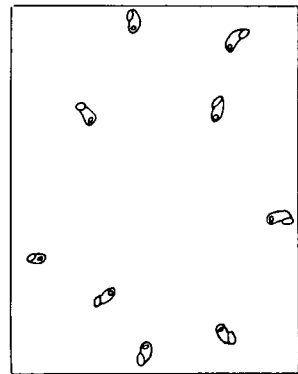

c

*Ethmodiscus rex*

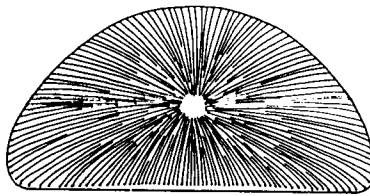

*Palmeria hardmaniana*

PLATE 18 *Coscinodiscus radiatus*: girdle view, flattened valves. Ring of processes close to margin. Scale bar = 20  $\mu\text{m}$ . *Coscinodiscus marginatus*: girdle view. Flattened valve, ring of processes close to junction between valve mantle and valve face. Scale bar = 20  $\mu\text{m}$ . *Ethmodiscus* spp.: (a) girdle view. Scale bar = 200  $\mu\text{m}$ .; (b) *E. gazellae* and (c) *E. rex*, valve center with processes. After Kolbe (1957). Scale bar = 10  $\mu\text{m}$ . *Palmeria hardmaniana*: valve view. From Allen & Cupp (1935). Scale bar = 10  $\mu\text{m}$ .

pp. 310 and 312, Figs. 8–32 and 35–39; Sancetta, 1987, p. 234, Plate 2, Figs. 1–10; Fryxell & Ashworth, 1988.

**Girdle view:** Cells discoid, flat, coin shaped. Numerous cocciform chloroplasts.

**Valve view:** Indistinct central rosette of slightly larger areolae. Areolae in radial rows, sometimes in indistinct decussating arcs (Figs. 6d and 6e). Small labiate processes at the points of origin of incomplete striae (interstitial meshes). No hyaline lines. One marginal ring of processes, including two slightly larger processes visible with LM as indentations of the valve margin, ca. 135° apart. The smaller marginal processes barely discernible.

**Distinctive features:** Flat cells, large areolae. Distinguished from *C. argus* by areolae of uniform size throughout the entire valve face and from *C. marginatus* by smaller areolae in more regular radial rows.

C. Frustules with a stepped elevated valve face.

***Coscinodiscus bouvet* Karsten (Plate 17, Tables 20a and 20b)**

**References:** Karsten, 1905, p. 83, Plate 3, Fig. 9; Hendey, 1937, p. 244, Plate 13, Figs. 3 and 4; Priddle & Thomas, 1989; E. Syvertsen, unpublished observations.

**Girdle view:** Cells about as high as wide, octagonal in outline due to an elevated area of the valve face, about one-half to two-thirds of the valve diameter, and occasionally with no elevation. Sometimes in chains (up to 18 cells). Numerous irregular stellate chloroplasts.

**Valve view:** Central rosette of larger areolae. Radial rows of areolae. One ring of processes, including two larger processes ca. 125° apart, close to the valve margin, visible with LM (water mounts).

**Distinctive features:** The shape of the cell in girdle view. In chains.

D. Frustules wedge shaped.

***Coscinodiscus granii* Gough (Plate 17, Tables 20a and 20b)**

**References:** Gough, 1905, p. 338, Fig. 3B; Hustedt, 1930, p. 436, Fig. 437; Boalch, 1971, Plate 1; Brooks, 1975; Karayeva & Dzharfarova, 1984; Takano, 1990, pp. 244–245; Hasle & Lange, 1992, p. 60, Figs. 63–76.

**Girdle view:** Cells asymmetric, one side much higher than the other. Valvocopula wedge shaped, widest opposite to the opening. Greatest convexity of the valve not in the center of the valve but nearest the widest part of the valvocopula. Chloroplasts discoid and smooth in outline.

**Valve view:** Central rosette of larger areolae. Radial areolation, incomplete striae, and decussating arcs in the central part of the valve. Cribra barely discernible with LM. One ring of marginal processes including two larger processes ca. 135° apart, readily seen with LM; the

larger processes seen as deep indentations of the valve mantle. Hyaline lines from the marginal processes toward the valve center more or less distinct.

**Distinctive features:** Cells wedge shaped in girdle view. Eccentric convexity of the valve, manifest with LM in valve view by only a part of the valve in focus. Valvocopula of uneven width, a second narrow band with rectangular, tall ligula positioned ca. 90° apart from the band opening (Hasle & Lange, 1992, Figs. 63 and 67).

It should be noted that the illustrations (Plates 15–18) show cells consisting of epitheca and incomplete hypotheca. The epithecae have, when known, the number of bands listed (Table 20a) with valvocopula included. The formation of all the bands of a hypotheca is usually first completed when the cell starts to divide.

**Distribution:**

*C. bouvet*—southern cold water region.

*C. alboranii*, *C. concinniformis*, and *C. jonesianus*—warm water region.

*C. wailesii*—warm water to temperate (recently introduced to North Atlantic waters).

The remaining species have a wide distribution according to the literature and may be cosmopolitan with a wide temperature tolerance.

**How to identify:** When not specifically mentioned, the morphological details are discernible with LM. *Coscinodiscus wailesii*, *C. bouvet*, and *C. granii* can be identified in water mounts in girdle view because of their special shape. To ensure a correct identification the remaining species should, in addition to water mounts, be examined as valves cleaned of organic matter and mounted in a medium of a high refractive index.

**Genus *Ethmodiscus* Castracane 1886 (Plate 18, Table 21)**

**Lectotype:** *Ethmodiscus gigas* Castracane selected by F. E. Round (*vide* Round et al., 1990, p. 206).

**Correct name:** *Ethmodiscus gazellae* (Janisch ex Grunow) Hustedt (*vide* Hustedt, 1930, p. 375).

TABLE 21 Morphometric Data of *Ethmodiscus* spp.

Species	Diameter (μm)	Areolae in 10 μm	Size of processes (μm) <sup>a</sup>
<i>E. gazellae</i>	1280–2000	6–9	2–4
<i>E. rex</i>	600–1900	6–8 (3) <sup>b</sup>	4–9

<sup>a</sup> Measured with the light microscope.

<sup>b</sup> No. in parentheses occasionally found.

**References:** Grunow, 1879, p. 688; Castracane, 1886, p. 169, Plate 14, Fig. 5; Rattray, 1890a; Hustedt, 1930, p. 374, Fig. 196; Wiseman & Hendey, 1953, p. 49, Plates 1 and 2; Kolbe, 1957, p. 33, Figs. 5 and 6, Plate 4, Figs. 46–49; Round, 1980; Rivera et al., 1989; Round et al., 1990, p. 206.

*Ethmodiscus rex* and *E. gazellae* are the only two of the 15 taxa recognized by VanLandingham (1969) that are regularly referred to. They are usually regarded as the largest single celled members of the marine phytoplankton having the shape of large boxes, with approximately equally sized diameters and perivalvar axes.

**Generic characters:**

Cell wall weakly silicified.

Valve areolae small, distinctly separated, in radial rows outside a central area.

Each theca with one wide band with wide hyaline margins and areolae in straight parallel rows.

Processes (revealed as labiate processes with SEM) in central part of the valve.

Heterovalvy, one strongly convex valve and the other with flattened valve face and a broad and flat mantle (Rivera et al., 1989).

**KEY TO SPECIES**

- 1a. Valve center with large (up to 50  $\mu\text{m}$  in diameter) nonareolated area bordered by an irregular ring of processes . . . . .  
 . . . . . *E. gazellae*<sup>8</sup> (Janisch ex Grunow) Hustedt
- 1b. Valve center irregularly areolated with nonareolated areas interspersed, central processes larger and scattered . . . . .  
 . . . . . *E. rex*<sup>8</sup> (Rattray) Hendey in Wiseman & Hendey

**Distribution:** Warm water region to temperate.

**How to identify:** Although the unusually large size may distinguish the genus in water mounts, examination of cleaned material on permanent mounts is needed to distinguish between the two species.

**Remarks:** Marginal labiate processes are present in *E. gazellae* (Round, 1980), but were not seen in *E. rex* (Rivera et al., 1989).

**Genus *Palmeria*** Greville 1865 (Plate 18, Table 22)

**Type:** *Palmeria hardmaniana* Greville.

<sup>8</sup> Basionyms: *Coscinodiscus gazellae* Janisch ex Grunow and *Coscinodiscus rex* Rattray, respectively.

**Synonym:** *Hemidiscus hardmanianus* (Greville) Mann.

**References:** Greville, 1865b, p. 2, Plate 5, Figs. 1–4; Ostenfeld, 1902, p. 222, Figs. 1 and 2; Mann, 1907, p. 316; Allen & Cupp, 1935, p. 152, Figs. 91 and 91a–91e; Simonsen, 1972, p. 270, Fig. 12; von Stosch, 1987, pp. 31–41, Figs. 1–45.

Generic characters:

Valves semicircular.

Hyaline central area.

Radial areolation with incomplete striae inserted from the margin.

Distinct hyaline lines associated with marginal processes.

Two processes larger than the others.

**KEY TO SPECIES (von Stosch, 1987, p. 32)**

- 1a. Valve face approximately plane . . . . . *P. hardmaniana* Greville
- 1b. Valve face excavated by deep narrow fold parallel to dorsal circumference of valve face and usually settled by epiphytic ciliates . . . . .  
 . . . . . *P. ostensfeldii*<sup>9</sup> (Ostenfeld) von Stosch

**Distribution:**

*P. hardmaniana*—warm water region.

*P. ostensfeldii*—Gulf of Thailand and Townsville, Australia (von Stosch, 1987), but may have a much wider distribution because it was confused with the former species in the past.

**How to identify:** The valve morphological structures are seen with LM by examination of material mounted in air or Pleurax (von Stosch, 1987). In *P. hardmaniana*, the ventral line of small labiate processes (those along the straight valve margin) is ca. 10 areolae away from the margin. In *P. ostensfeldii*, it is ca. 20 areolae from the straight margin in its middle part.

**TABLE 22 Morphometric Data of *Palmeria* spp.**

Species	Length (µm)	Width (µm)	Areolae in 10 µm
<i>P. hardmaniana</i>	303–534	162–270	12–14
<i>P. ostensfeldii</i>	352–650	189–300	13–15

*Note.* Length is measured along the straight margin of the valve; width is the greatest distance from the curved to the straight margin of the valve.

<sup>9</sup> = *Palmeria hardmaniana* in Ostenfeld, 1902.

**Family Stellarimaceae** Nikolaev 1983 ex Sims & Hasle 1990

To date the family includes *Stellarima* Hasle & Sims with living and fossil members and the fossil genus *Fenestrella* Greville (Sims, 1990). The family is based on *Stellarima* Hasle & Sims.

**Genus *Stellarima*** Hasle & Sims 1986 (Plate 19, Table 23)

**Type:** *Stellarima microtrias* (Ehrenberg) Hasle & Sims.

**Basionym:** *Symbolophora? microtrias* Ehrenberg.

**Synonyms:** *Coscinodiscus symbolophorus* Grunow; *C. furcatus* Karsten; *Symbolophora furcata* (Karsten) Nikolaev.

**References:** Ehrenberg, 1844b, p. 205; Roper, 1858, p. 21, Plate 3, Fig. 3; Grunow, 1884, p. 82, Plate 4, Figs. 3–6; Karsten, 1905, p. 82, Plate 4, Fig. 7; Hustedt, 1930, p. 396, Figs. 207 and 208; Cupp, 1943, p. 53, Fig. 16; Hustedt, 1958a, pp. 113 and 118, Figs. 18, 19, 36–39, and 47; Nikolaev, 1983; Syvertsen, 1985, p. 113, Figs. 1–14; Hasle & Sims, 1986b; Hasle et al., 1988; Fryxell, 1989, p. 4, Figs. 6–17; Hasle & Syvertsen, 1990c.

**Generic characters:**

Cells drum shaped, discoid, or lenticular.

Valves more or less convex depending on size of diameter.

Areolae in radial rows.

Areolae loculate, cribra external, foramina internal (SEM).

“Specialized areolae” with a special type of velum (SEM).

Center of valve with small hyaline area with one or a single group of (two to eight) labiate processes (SEM).

No marginal processes.

Many small chloroplasts, irregular (angular?) in outline.

**KEY TO LIVING SPECIES**

- 1a. Valves distinctly convex, areolation fasciculate . . . . . 2
- 1b. Valves flat to slightly convex, areolation furcate . . . . .  
     . . . . . *S. microtrias* (Ehrenberg) Hasle & Sims, vegetative cells
- 2a. Many areola rows per sector, areolae small . . . . .  
     . . . . . *S. stellaris*<sup>10</sup> (Roper) Hasle & Sims
- 2b. Sectors narrower, areolae larger . . . . .  
     . . . . . *S. microtrias* (Ehrenberg) Hasle & Sims, resting spores

<sup>10</sup> Basionym: *Coscinodiscus stellaris* Roper.

*Stellarima*

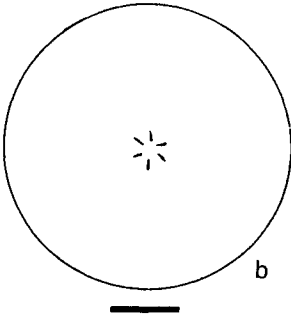
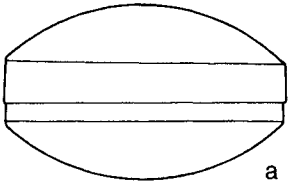

*S. stellaris*

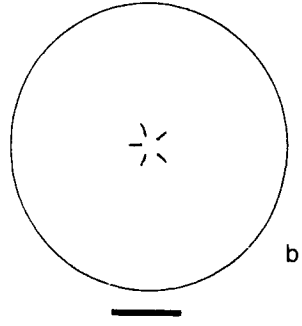
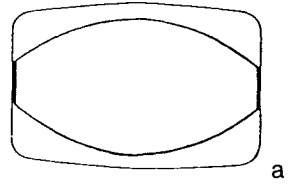

*S. microtrias*

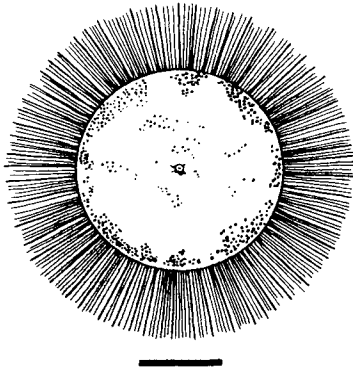

*Gossleriella tropica*

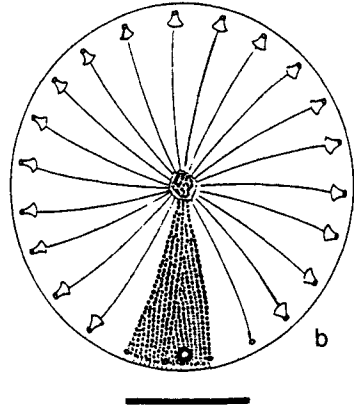
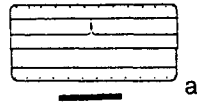

*Actinocyclus curvatulus*

TABLE 23 Morphometric Data of *Stellarima* spp. (Hasle et al., 1988)

Species	Diameter (µm)	Areolae in 10 µm	Striae in 10 µm	Rows/sector
<i>S. microtrias</i> , veg. cells	35–105	11–15	12–16	No sectors
<i>S. microtrias</i> , rest. spores	40–100	9–11	10–12	10–17
<i>S. stellaris</i>	40–115	15–16	18–22	30–40

**Distribution:**

*S. microtrias*—southern cold water region—particularly common on and in fast sea ice and in the surrounding plankton.

*S. stellaris*—warm water region to temperate, planktonic.

**How to identify:** The species may be identified in valve view in water mounts although examination of valves cleaned of organic matter and mounted in a medium of a high refractive index may be needed in most cases, especially to identify *S. stellaris*.

**Remarks:** *Stellarima microtrias* forms heavily silicified endogenous resting spores, usually identified as *C. symbolophorus*, inside weakly silicified cells previously identified as *C. furcatus* (Syvertsen, 1985). *Stellarima stellaris* has not been found to form resting spores. The labiate processes are readily observed with LM in the lightly silicified *S. stellaris* (e.g., Cupp, 1943, Fig. 16) and are less easily seen in the *S. microtrias* resting spores. *Stellarima microtrias* was found in long chains in living natural material (Fryxell, 1989) as well as in cultures (G. Hasle, personal observations on a M. Elbrächter isolate). The attachment point was central to eccentric on sibling valves.

*Incertae sedis* (Stellarimaceae)**Genus *Gossleriella* Schütt 1892**

**Type:** *Gossleriella tropica* Schütt.

Monospecific genus.

The taxonomic position of this genus is disputed. Hargraves (1976) suggested Rhizosoleniaceae as a possible family; Simonsen (1979)

PLATE 19 *Stellarima stellaris*: (a) girdle view; (b) valve with central labiate processes. Scale bar = 20 µm. *Stellarima microtrias*: (a) girdle view with endogenous resting spore; (b) valve with central labiate processes. From Hasle & Syvertsen (1990c). Scale bar = 20 µm. *Gossleriella tropica*: valve with girdle spines. From Hustedt (after Schütt) (1930). Scale bar = 100 µm. *Actinocyclus curvatulus*: (a) cell in girdle view; (b) valve with curvatulus structure indicated in two sectors with the pseudonodulus located in one. Scale bars = 20 µm.



retained it in Coscinodiscaceae, and Round et al. (1990) introduced the monotypic family Gossleriellaceae Round. Nikolaev (1983) placed it in the family he described as Symbolophoraceae which was later renamed Stellarimaceae (Sims & Hasle 1990). The justification for this classification is the absence of a marginal ring of processes and a single central labiate (SEM) process similar in shape to those of *Stellarima*. The genus most probably comprises only the generitype.

***Gossleriella tropica* Schütt (Plate 19)**

**References:** Schütt, 1892, p. 258, Fig. 63; Hustedt, 1930, p. 500, Fig. 280; Hargraves, 1976; Delgado & Fortuño, 1991, Plate 44, Fig. b.

**Girdle view:** Discoid with flat or slightly convex valves and a ring of siliceous spines attached to the cingulum. Chloroplasts numerous small plates, each with a pyrenoid.

**Valve view:** Valve surface poroid. A single process in or near valve center.

**Morphometric data:** Pervalvar axis ca. 5–7.5  $\mu\text{m}$ ; diameter of a valve without spines 96–250  $\mu\text{m}$ , with spines 162–293  $\mu\text{m}$  (Hargraves, 1976).

**Distribution:** Warm water region—lower photic zone (Hargraves, 1976).

**How to identify:** Whole cells are easily identified in water mounts; the valve structure is visible with LM by examination of cleaned material in permanent mounts.

**Family Hemidiscaceae** Hendey 1937 emend. Simonsen 1975 ex Hasle 1995 Hasle (this publication)

Terminology specific to Hemidiscaceae

**Pseudonodulus**—a marginal to submarginal structure, always only one per valve, with LM evident as an open hole or an area covered by densely packed smaller areolae.

The pseudonodulus is the principle diagnostic feature of the Hemidiscaceae as emended by Simonsen (1975) and encompassing *Actinocyclus*, *Hemidiscus* and *Roperia*. Watkins & Fryxell (1986) questioned the taxonomic preeminence of the pseudonodulus, and Fryxell et al., 1986b, p. 33) found that the best place for *Azpeitia*, which has no pseudonodulus, was within Hemidiscaceae. This placement was “based in part on the fact that the Coscinodiscaceae is ill-defined at the present dynamic stage of diatom systematics.”

Glezer et al. (1988) placed *Actinocyclus*, *Hemidiscus*, and *Roperia* in Hemidiscaceae whereas the monotypic family Azpeitiaceae Glezer & Makarova was introduced for *Azpeitia*. Round et al. (1990) followed Fryxell et al. (1986b), placing *Azpeitia* and the three genera mentioned in Hemidiscaceae.

Characters common to *Actinocyclus*, *Azpeitia*, *Hemidiscus*, and *Roperia*:

Cells low cylindrical to discoid.

Few bands, unperforate (hyaline).

Areolae loculate (SEM).

Cribræ external, foramina internal (SEM).

Valve areolation radial, often fasciculate.

Valve face and mantle more or less different in areolation.

One marginal ring of large labiate processes, similar in shape and generally also in size.

### KEY TO GENERA

- 1a. Pseudonodulus present (sometimes revealed only with EM) . . . . . 2
- 1b. Pseudonodulus absent, central labiate process present (sometimes revealed only with EM) . . . . . *Azpeitia*, p. 123
- 2a. Valves circular or elliptical. . . . . 3
- 2b. Valves semicircular . . . . . *Hemidiscus*, p. 128
- 3a. Areolation radial, usually fasciculate . . . . . *Actinocyclus*, p. 117
- 3b. Areolation basically linear in central portion of the valve, fasciculate or radial in marginal part . . . . . *Roperia*, p. 130

**Genus *Actinocyclus*** Ehrenberg 1837

**Lectotype:** *Actinocyclus octonarius* Ehrenberg (*vide* Boyer, 1927, p. 80).

VanLandingham (1967) listed 80–90 validly described *Actinocyclus* species of which only 4 or 5 are commonly recorded from marine or brackish water plankton. This chapter includes these 5 taxa and other marine planktonic species newly described or transferred to *Actinocyclus*.

Generic characters:

Valvocopula wide, a narrow second band with ligula, and a probable narrow third band.

Valve mantle deep and straight.

Valve outline circular.

Areola pattern usually fasciculate.

Marginal zone often denser in areolation and/or different in direction of the striae.

Central annulus, variable in size and presence.

No labiate process in valve center.

Marginal ring of labiate processes.

Pseudonodulus, variable in size.

Characters showing differences between species:

Type of fasciculation.

Position of labiate processes: at the end of edge and/or central areola row of a fascicle.

Distinct or indistinct annulus.

Distinct or indistinct pseudonodulus.

Position of pseudonodulus.

The 11 *Actinocyclus* species dealt with here exhibit three different types of fasciculation:

- A. Radial areola rows parallel to central row: *A. actinochilus*, *A. circellus*, *A. kützingii*, *A. normanii*, *A. octonarius*, *A. sagittulus*, and *A. subtilis* (Table 24).
- B. Radial areola rows parallel to edge (side) row: *A. curvatulus* and *A. exiguus* (Table 25).
- C. Areola rows parallel to central and/or edge row: *A. spiritus* and *A. vestigulus* (Table 26).

TABLE 24 Morphometric Data of *Actinocyclus* spp. with Areola Rows Parallel to the Central Row of the Fascicles

Species	Pervalvar axis ( $\mu\text{m}$ )	Diameter ( $\mu\text{m}$ )	Valve areolae in 10 $\mu\text{m}$	Marginal striae in 10 $\mu\text{m}$	$\mu\text{m}$ Between marginal proc.
<i>A. actinochilus</i>	7–17	20–112	5–11	13–21	9.5–15
<i>A. circellus</i>	28	88–140	8–9	17	7–9
<i>A. kützingii</i>	—	30–70	7–8	10–12	—
<i>A. normanii</i> f. <i>normanii</i>	—	30–110	ca. 9	—	—
<i>A. normanii</i> f. <i>subsalsaa</i>	—	16–44	8–11	18–22	—
<i>A. octonarius</i> var. <i>octonarius</i>	—	50–300	6–8	15	8–11
<i>A. octonarius</i> var. <i>tenellus</i>	—	18–48	8.5–11.5	17–23	10–16
<i>A. sagittulus</i>	—	41–110	8.5–10.5	15–18	7–9
<i>A. subtilis</i>	—	35–160	12–18	—	7

Note. Proc., processes; —, no data.

A. Radial areola rows parallel to central row.

***Actinocyclus actinochilus*** (Ehrenberg) Simonsen (Table 24)

**Basionym:** *Coscinodiscus actinochilus* Ehrenberg.

**Synonym:** *Charcotia actinochila* (Ehrenberg) Hustedt.

**References:** Ehrenberg, 1844b, p. 200; Ehrenberg, 1854, Plate 35A/21, Fig. 5; Hustedt, 1958a, p. 126, Figs. 57–80; Hasle, 1968b, p. 7, Plate 9, Fig. 6, Map 2; Simonsen, 1982; Villareal & Fryxell, 1983, p. 461, Figs. 21–32.

Large labiate processes, clearly seen with LM, positioned in an apparently hyaline band between valve areola rows and margin, at end of edge rows of fascicles. The presence and structure of a central annulus and the presence and width of hyaline spaces between radial areola rows variable. Pseudonodulus of about the same size as an areola, located in the hyaline band, evident in LM although difficult to recognize in many specimens, ranges internally (SEM) from a large circular depression to a small hole with a central depression (Villareal & Fryxell, 1983).

***Actinocyclus circellus*** T. P. Watkins in Watkins & Fryxell (Table 24)

**Reference:** Watkins & Fryxell, 1986, p. 294, Figs. 1–8.

Pronounced central annulus enclosing areolae usually smaller than those on the rest of the valve and more or less linearly arranged. Areolae on the rest of the valve arranged in irregular, obscure fascicles. Labiate processes, discernible with LM, positioned at the end of the central and edge row of each fascicle. Pseudonodulus slightly away from the marginal ring of processes toward the valve center, easily discernible with LM.

***Actinocyclus kützingii*** (A. Schmidt) Simonsen (Table 24)

**Basionym:** *Coscinodiscus kützingii* A. Schmidt.

**References:** Schmidt, 1878, Plate 57, Figs. 17 and 18; Hustedt, 1930, Fig. 209; Simonsen, 1975, p. 92.

Pseudonodulus, very small, obscure. Areolation fasciculated with secondary, curved rows. Marginal processes discernible with LM, positioned at the end of the central row of each fascicle. Fairly wide marginal zone, structure consisting of small areolae in two crossing systems. Small central annulus.

***Actinocyclus normanii*** (Gregory) Hustedt f. *normanii* (Table 24)

**Basionym:** *Coscinodiscus normanii* Gregory (in Greville, 1859a).

**References:** Greville, 1859a, p. 80, Plate 6, Fig. 3; Hustedt, 1957, p. 218; Hasle, 1977, Figs. 2, 11–17, 20 and 21.

***Actinocyclus normanii* f. *subsalsus*** (Juhlin-Dannfelt) Hustedt (Table 24)

**Basionym:** *Coscinodiscus subsalsus* Juhlin-Dannfelt.

**References:** Juhlin-Dannfelt, 1882, p. 47, Plate 3, Fig. 33; Hustedt, 1957, p. 219; Hasle, 1977, Figs. 1, 3–10, 15–19, 22, and 23.

Width of sectors, number of complete areola rows and relationship between number of fascicles and marginal labiate processes variable. Position of processes at the end of central rows of fascicles more stable. Processes readily discernible in water mounts. Pseudonodulus positioned in the bend between valve face and mantle and thus more difficult to discover. Central annulus indistinct or missing.

**Remarks:** The two taxa especially differ in size and also slightly in ecology but not in morphology, and are regarded here as forms.

***Actinocyclus octonarius* Ehrenberg (Table 24)**

**Synonym:** *Actinocyclus ehrenbergii* Ralfs in Pritchard.

**References:** Ehrenberg, 1838, p. 172, Plate 21, Fig. 7; Pritchard, 1861, p. 834; Hustedt, 1930, p. 525, Figs. 298–302; Hendey, 1964, p. 83, Plate 24, Fig. 3; Villareal & Fryxell, 1983, p. 453, Figs. 1–14.

Areolation distinctly fasciculated giving the impression of the valve face being divided into “compartments.” Fascicles separated by pronounced complete striae running from the margin to a more or less well developed central annulus. Fasciculation accentuated by hyaline areas filling out spaces left open by shorter rows adjacent to the complete striae. A wide marginal zone with areolae smaller than those on the valve face. Processes positioned at the end of edge rows and a large pseudonodulus in the bend between valve face and mantle are readily seen with LM.

**Remarks:** Four varieties, in addition to the nominate variety dealt with by Hustedt (1930), differ in size and development of the central annulus, the amount of hyaline spaces and the width of the marginal zone. The central annulus was shown to be highly variable in cultured material of *A. octonarius* var. *tenellus*, whereas the valve areolation was stable (Villareal & Fryxell, 1983).

***Actinocyclus sagittulus* Villareal in Villareal & Fryxell (Table 24)**

**Reference:** Villareal & Fryxell, 1983, p. 458, Figs. 15–20.

Areolation weakly fasciculated, hyaline spaces and a marginal zone less pronounced than in *A. octonarius*, otherwise similar to this species by the presence of a central annulus and in morphometric data. Marginal processes and a large pseudonodulus discernible with LM. A special feature, located close to the pseudonodulus and considered diagnostic, is evident with LM as a small heavily silicified arrowhead shaped region pointing to the valve center (Villareal & Fryxell, 1983).

***Actinocyclus subtilis* (Gregory) Ralfs in Pritchard (Table 24)**

**Basionym:** *Eupodiscus subtilis* Gregory.

**References:** Gregory, 1857, p. 501, Plate 11, Fig. 50; Pritchard, 1861, p. 835; Hustedt, 1930, p. 534, Fig. 304.

Distinct irregularly delimited central annulus filled by closely spaced areolae. Narrow, inconspicuous bundles of more or less wavy, radial areolae rows with processes at the ends of edge rows. Valve face with incomplete striae and hyaline spaces resulting in a spotted appearance, absent on valve mantle. Large pseudonodulus positioned on valve face and labiate processes on valve mantle easily discerned with LM.

**Remarks:** The central annulus, the pseudonodulus and the densely areolated valve structure are the features emphasized in the original description of the species.

**Distribution:**

- A. actinochilus*—southern cold water region.
- A. circellus*, *A. sagittulus*—warm-water region?
- A. octonarius* and *A. subtilis*—cosmopolitan.
- A. normanii*—brackish water, probably cosmopolitan.
- A. kützingii*—known from North Atlantic coastal waters.

B. Radial areola rows parallel to edge (side) row.

*Actinocyclus curvatus* Janisch in A. Schmidt (Plate 19, Table 25)

**Synonyms:** *Coscinodiscus curvatus* var. *subocellatus* Grunow, *Actinocyclus subocellatus* (Grunow) Rattray.

**References:** Schmidt, 1878, Plate 57, Fig. 31; Grunow, 1884, p. 82, Plate 4, Figs. 8–16; Rattray, 1890b, p. 145; Hustedt, 1930, p. 538, Fig. 307.

Areola rows slightly curved. A process at the end of each side row of the fascicles. Central annulus irregular in shape. Areolae decreasing in size close to the margin. Small irregular pseudonodulus located close to valve mantle.

**Remarks:** *Actinocyclus curvatus* was described by means of Plate 57, Fig. 31 in Schmidt's Atlas (1878), which illustrates a part of a valve ca. 110  $\mu\text{m}$  in diameter. The prominent feature is the type of fasciculation.

*Coscinodiscus curvatus* Grunow (Schmidt's Atlas 1878; Plate 57, Fig. 33) with several varieties has the same fasciculation as *Actinocyclus curvatus*.

TABLE 25 Morphometric Data of *Actinocyclus* spp. with Areola Rows Parallel to Edge (Side) Row of the Fascicles

Species	Diameter ( $\mu\text{m}$ )	Valve areolae in 10 $\mu\text{m}$	Marginal strutted processes in 10 $\mu\text{m}$	$\mu\text{m}$ between marginal proc.
<i>A. curvatus</i>	13–160	8–18	12–18	7–9
<i>A. exiguus</i>	6.5–13	15–18	21–24	—

Note. Proc. processes. —, no data.

This Page Intentionally Left Blank

and the margin, and by the lack of isolated rows of areolae typical for *A. actinochilus*.

***Actinocyclus vestigulus*** T. P. Watkins in Watkins & Fryxell (Table 26)

**Reference:** Watkins & Fryxell, 1986, p. 296, Figs. 9–16.

Sometimes with a not very distinct, more or less central annulus with the smaller areolae almost linearly arranged. Position of labiate processes in relation to the irregular fascicles obscure. Pseudonodulus difficult to see with LM.

**Distribution:**

*A. spiritus*—southern cold water region

*A. vestigulus*—warm water region?

**How to identify:** The *Actinocyclus* species presented here can hardly be identified as whole cells in water mounts since, as far as known, they all have numerous small chloroplasts lying against the cell wall and more or less the same cell shape. *Actinocyclus* spp. may easily be confused with *Coscinodiscus* spp. and *Azpeitia* spp. when seen in water mounts, and examination of cleaned material mounted in a medium of a high refractive index is necessary to ensure correct identification.

**Remarks:** The pseudonodulus was not mentioned in the original description of the genus, but was first noted by Smith (1853) according to Simonsen (1975), and is now regarded as typical for the genus. In some species the pseudonodulus is similar to a valve areola in size and structure, and/or it is positioned in the bend between valve face and mantle. This explains why it has so often been overlooked (Simonsen, 1982). The morphology of the pseudonodulus varies considerably within the genus as well as within one species. Andersen et al. (1986) showed that each labiate process of the *Actinocyclus* sp. that they examined contained material which they proposed is related to movement noted in this centric diatom. Their investigation thus throws light upon the long-speculated function of the labiate process.

**Genus *Azpeitia*** M. Peragallo in Tempère & Peragallo

**Type:** *Azpeitia temperi* M. Peragallo.

**Correct name:** *Azpeitia antiqua* (Pantocseck) Sims (*vide* Fryxell et al., 1986b, p. 6).

**References:** Fryxell et al., 1986b; Sims et al., 1989.

The genus was described from fossil material and encompasses living marine planktonic species as well. The living ones are better known as *Coscinodiscus* spp. and were transferred to *Azpeitia* by Fryxell et al. (1986b).



## Generic characters:

Marked difference in the areola patterns on valve face and mantle.

Valves generally flat.

Valve center generally with an annulus.

Large nearly central labiate process on the edge of the annulus.

A ring of large labiate processes, similar in shape, at the edge of valve mantle.

## Characters showing differences between species:

Valve face areolation: pattern and areola size.

Position and shape of annulus.

Size of labiate processes.

Shape and structure of bordering zone between valve face and mantle (hyaline, marginal ridge).

*Azpeitia africana* (Janisch ex A. Schmidt) G. Fryxell & T. P. Watkins in Fryxell et al. (Plate 20, Table 27)

**Basionym:** *Coscinodiscus africanus* Janisch ex A. Schmidt.

**References:** Schmidt, 1878, Plate 59, Figs. 24 and 25; Hustedt, 1930, p. 428, Fig. 231; Fryxell et al. 1986b, p. 22, Figs. 22, 23, 32-1, and 32-2.

Valves circular, sometimes slightly elliptical. Distinct external marginal slits leading into labiate processes. Central labiate process on edge of an eccentric circle of linearly arranged areolae. Areola rows radiating from the annulus and, in larger specimens, in spiraling rows.

*Azpeitia barronii* G. Fryxell & T. P. Watkins in Fryxell et al. (Plate 20, Table 27)

**Reference:** Fryxell et al. 1986b, p. 20, Figs. 18-3, 18-5, 19-21, and 31.

Sublinear areolation. Areolae of same size over most of the valve. Curved marginal ridge; some rounding between valve mantle and face. Central labiate process large, noticeable with LM. Central annulus possibly missing.

*Azpeitia neocrenulata* (VanLandingham) G. Fryxell & T. P. Watkins in Fryxell et al. (Plate 20, Table 27)

**Basionym:** *Coscinodiscus neocrenulatus* VanLandingham.

**Synonym:** *Coscinodiscus crenulatus* Grunow *non* *C. crenulatus* Castracane.

**References:** Grunow, 1884, p. 83, Plate 4, Fig. 17; Hustedt, 1930, p. 411, Fig. 219; VanLandingham, 1968, p. 930; Fryxell et al. 1986b, p. 18, Figs. 16, and 30-2.

Areolation fasciculated with radial rows of areolae usually parallel to an edge row. Marginal labiate process and a depression on the mantle at the

*Azpeitia*

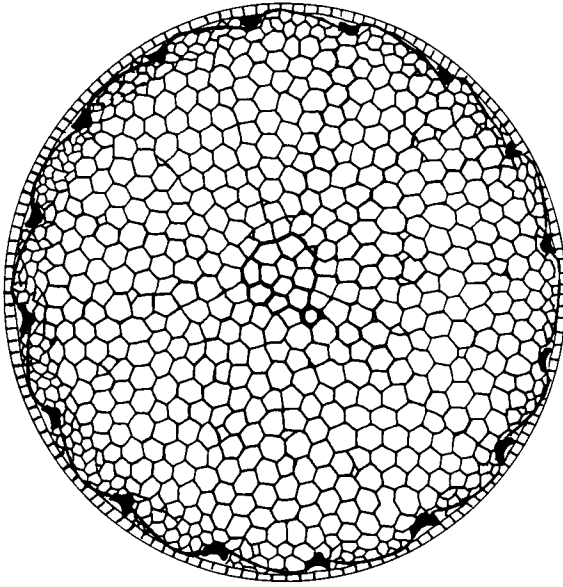

*A. africana*

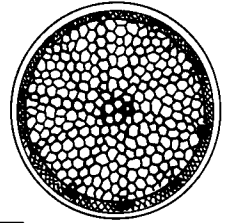

*A. neocrenulata*

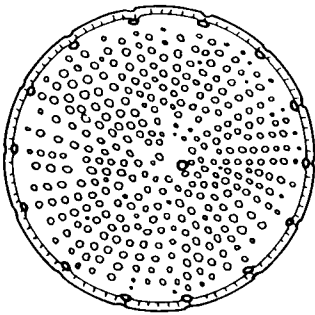

*A. tabularis*

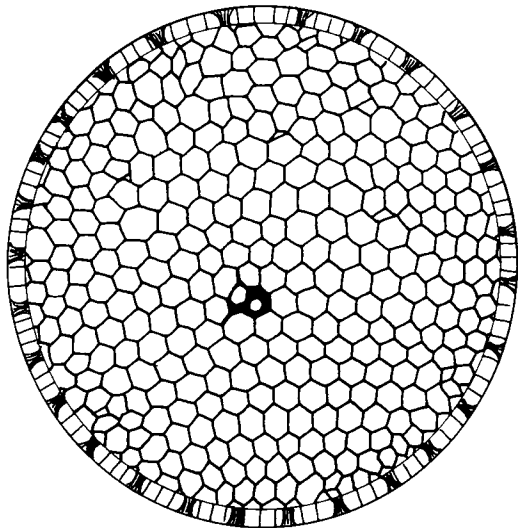

*A. barronii*

PLATE 20 *Azpeitia africana*, *A. neocrenulata*, *A. tabularis*, and *A. barronii*. Valves with areolation. Scale bar = 10  $\mu$ m.

TABLE 27 Morphometric Data of *Azpeitia* spp. (Fryxell et al., 1986b)

Species	Pervalvar axis ( $\mu\text{m}$ )	Diameter ( $\mu\text{m}$ )	Valve areolae in 10 $\mu\text{m}$	Distance <sup>a</sup> ( $\mu\text{m}$ )
<i>A. africana</i>	— <sup>b</sup>	30–90	5–10	3–6
<i>A. barronii</i>	ca. 10	39–95	3–5	4–7
<i>A. neocrenulata</i>	6	13–48	9–11	4–7
<i>A. nodulifera</i>	17–18	20–102	3–8	5–9
<i>A. tabularis</i>	7	16–70	5–9	7–12

<sup>a</sup> Distance between marginal processes.

<sup>b</sup> —, No data.

end of each edge row. Large labiate process at the edge of a central annulus. Mantle extremely fine in structure (20 striae in 10  $\mu\text{m}$ ).

*Azpeitia nodulifera* (A. Schmidt) G. Fryxell & P. A. Sims in Fryxell et al. (Plate 21, Table 27)

**Basionym:** *Coscinodiscus nodulifer* A. Schmidt.

**References:** Schmidt, 1878, Plate 59, Figs. 20, 22, and 23; Hustedt, 1930, p. 426, Fig. 229; Fryxell et al. 1986a, p. 19, Figs. 17, 18-1–18-5, 30-3, and 30-4; Takano, 1990, pp. 254–255.

Heavily silicified with flat valves and vertical mantle. Areolation radial with large and small areolae mixed. Marginal ridge straight.

*Azpeitia tabularis* (Grunow) G. Fryxell & P. A. Sims in Fryxell et al. (Plate 20, Table 27)

**Basionym:** *Coscinodiscus tabularis* Grunow.

**References:** Schmidt, 1878, Plate 57, Fig. 43; Grunow, 1884, p. 86; Hustedt, 1930, p. 427, Fig. 230; Fryxell et al. 1986b, p. 16, Figs. 14, 15, and 30-1.

Distinctive hyaline ring between valvar areolae and rows of mantle areolae. Areolation radial. Marginal processes wide apart. A wide range of morphological variation was noted by Fryxell et al. (1986b).

#### Distribution:

*A. africana*, *A. barronii*, *A. neocrenulata*, and *A. nodulifera*—warm water region.

*A. tabularis*—southern cold water region with a preference for subantarctic waters.

**How to identify:** Cleaned frustules on permanent mounts observed in valve view will usually be necessary for a correct identification. *Azpeitia africana* will be readily recognized with LM by the central area and the marginal

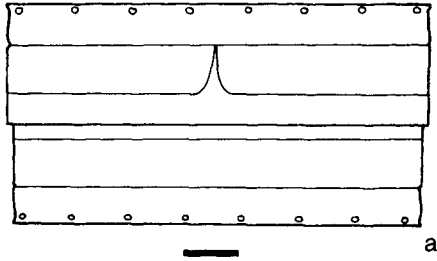

a

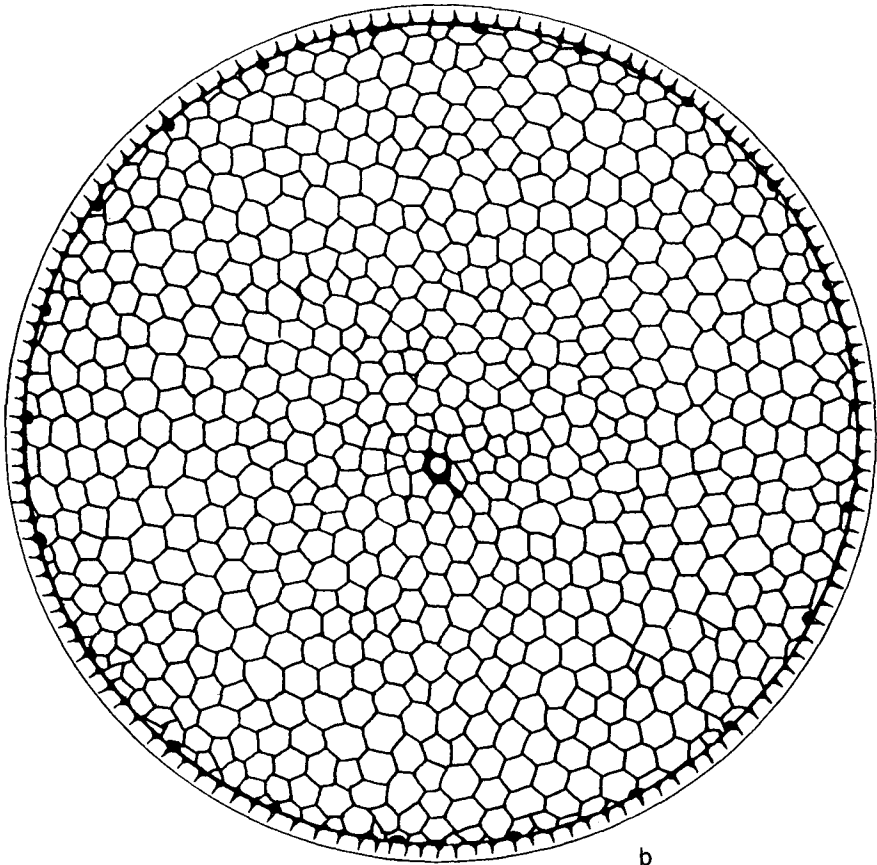

b

*Azpeitia nodulifera*

PLATE 21 *Azpeitia nodulifera*: (a) girdle view, steep mantle; (b) valve with areolation. Scale bar = 10  $\mu\text{m}$ .

slits leading into the processes, *A. tabularis* by the hyaline ring close to the margin, *A. neocrenulata* by the depressions on the valve mantle, and *A. nodulifera* by the large labiate process close to valve center. *Azpeitia barronii*, which also has a large central labiate process, is distinguished from *A. nodulifera* by its sublinear pattern of equally sized areolae over most of the valve.

**Genus *Hemidiscus* Wallich 1860 (Plate 22, Table 28)**

**Type:** *Hemidiscus cuneiformis* Wallich.

**References:** Wallich, 1860, p. 42, Plate 2, Figs. 3 and 4; Hustedt, 1930, p. 904, Fig. 542; Cupp, 1943, p. 170, Fig. 121; Hendey, 1964, p. 94, Plate 22, Fig. 9; Simonsen, 1972, 1975; Fryxell et al. 1986b, p. 25, Fig. 26.

The genus encompasses two species, the type, and *Hemidiscus kanayanus* Simonsen (Simonsen 1972).

Generic characters:

Valves semicircular.

Areolation radial, partly in bundles.

Central annulus.

Marginal ring of labiate processes with a pseudonodulus midway on the straight margin.

Characters showing differences between species:

Size of areolae.

Fasciculation distinct in *H. cuneiformis*, indistinct in *H. kanayanus*.

Annulus distinct in *H. kanayanus*.

**Distribution:**

*H. kanayanus*—warm water region (described from the Indian Ocean, recorded also from the equatorial Pacific).

*H. cuneiformis*—warm water region (may be transported far north along the Norwegian coast; Hustedt, 1930).

**How to identify:** The subcircular valve outline is shared with *Palmeria* and may cause confusion if the material is examined as whole cells in water mounts. The distinctive feature of *Hemidiscus*, the pseudonodulus, is readily

---

PLATE 22 *Hemidiscus cuneiformis*: (a) cell in girdle view; (b) valve. Scale bar = 50  $\mu\text{m}$ . *Roperia tessellata*: (a) cell in girdle view; (b) valve with areolation and pseudonodulus. Scale bar = 10  $\mu\text{m}$ . *Pseudoguinaradia recta*: chain in girdle view. After von Stosch (1986). Scale bar = 50  $\mu\text{m}$ . *Actinoptychus senarius*: (a) girdle view with undulated valve; (b) valve with sectors. Scale bar = 10  $\mu\text{m}$ .

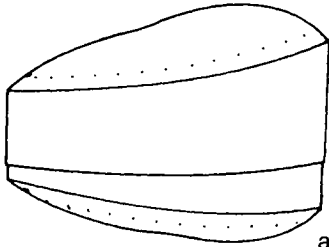

a

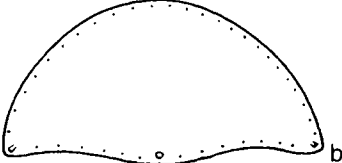

b

*Hemidiscus cuneiformis*

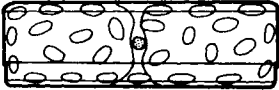

a

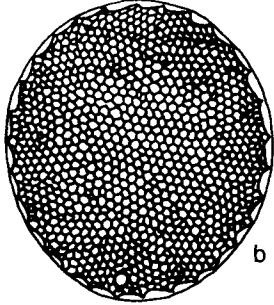

b

*Roperia tessellata*



—

*Pseudoguinaridia recta*

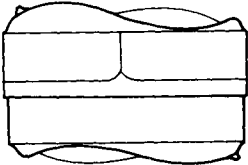

a

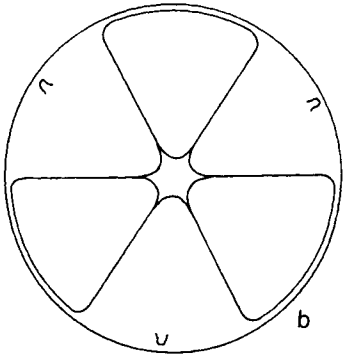

b

*Actinoptychus senarius*

TABLE 28 Morphometric Data of *Hemidiscus* spp. (Simonsen, 1972)

Species	Length ( $\mu\text{m}$ )	Width ( $\mu\text{m}$ )	Areolae in 10 $\mu\text{m}$	
			Center	Margin
<i>H. cuneiformis</i>	58–288	32.5–158	6–9	10–13
<i>H. kanayanus</i>	111–225	76–120	14–18	14–18

*Note.* Length is measured along the more straight margin of the valve; width is the greatest distance from the curved to the more straight margin of the valve.

seen with LM in cleaned material as are the morphological distinctive structures of the two *Hemidiscus* species.

### Genus *Roperia* Grunow ex Pelletan 1889 (Plate 22)

**Type:** *Roperia tessellata* (Roper) Grunow ex Pelletan.

**Basionym:** *Eupodiscus tessellatus* Roper.

**References:** Roper, 1858, p. 19, Plate 3, Fig. 1; Van Heurck, 1880–1885, Plate 118, Figs. 6 and 7; Hustedt, 1930, p. 523, Fig. 297; Hendeby, 1964, p. 85, Plate 22, Fig. 3; Fryxell et al. 1986b, p. 24, Figs. 25, 32-3, 32-4; Lee & Lee, 1990.

Valve outline circular to ovate. Marginal ring of processes—all similar in size and shape. Pseudonodulus prominent. Central and marginal part of valve usually different in areolation.

**Morphometric data:** Diameter, 40–70  $\mu\text{m}$ ; valve areolae, six in 10  $\mu\text{m}$  in central part, somewhat smaller near margin; marginal processes, two in 10  $\mu\text{m}$  (Hustedt, 1930).

**Distribution:** Recorded as far north as 66°N in the Norwegian Sea and as far south as 57°S in the subantarctic Pacific by Hasle (1976a) who, with doubt, classified it as a warm water species. The paucity of records from the Pacific Ocean as well as from the western part of the Atlantic Ocean north of 30°N made the classification “cosmopolitan” just as doubtful.

### *Incertae sedis* (Hemidiscaceae)

#### Genus *Pseudoguinaridia* von Stosch 1986

**Type:** *Pseudoguinaridia recta* von Stosch.

Monotypic genus.

#### *Pseudoguinaridia recta* von Stosch (Plate 22)

**Reference:** von Stosch, 1986, p. 307, Figs. 7–11.

**Girdle view:** Cells cylindrical in long straight colonies. Bands with poroids (TEM) numerous, open, not or barely discernible with LM. Chloroplasts numerous, subglobular with a large globular pyrenoid.

**Valve view:** Valve outline circular. Valve face flat; mantle low and rounded. Pseudonodulus close to valve margin, discernible (LM) in valve view as a circular hyaline area. Marginal ring of small labiate processes (SEM) and one larger labiate process discernible (LM) as a small nodule in girdle view. Valve face structure composed of faint, branched lines oriented toward a diameter (a line) combining pseudonodulus and the large labiate process (LM). Scattered poroids on valve face and mantle (TEM).

**Morphometric data:** Pervalvar axis, 93–270  $\mu\text{m}$ ; diameter, 26–83  $\mu\text{m}$ ; ratios of peralvar axis to diameter, 3.0–6.7 in smaller and 1.6–3.9 in larger cells.

**Distribution:** Warm water region—listed by von Stosch (1986) from Australian waters, the Indian Ocean, coastal waters off Northwest Africa, off Portugal, both coasts of Florida and the Mediterranean Sea. Other records are from Columbian and Californian coastal waters (G. Hasle, personal observations) and from the Gulf Stream warm core rings (Fryxell, personal communication).

**How to identify:** *Pseudoguinaridia recta* is easily recognized in chains and as single whole cells in girdle view in water mounts; single valves are also recognizable with LM on permanent mounts.

**Remarks:** Von Stosch (1986) assigned *Pseudoguinaridia* a provisional place in Hemidiscaceae on the assumption that the structures interpreted as a pseudonodulus and labiate processes were correctly named. As evident from the generic characters, particularly the numerous structured bands and the valve structure, it differs from the four genera assigned to Hemidiscaceae in this chapter on most or all other characters. No other described family can be pointed out as the right place for this species. In the past *P. recta* has most probably been identified as *Guinaridia flaccida* or *Leptocylindrus* sp. It differs (LM) from *G. flaccida* by the straight chains, the indistinct bands, the presence of the pseudonodulus, the shape and number of labiate processes, and the orientation of the valve structure, and from *Leptocylindrus* spp. by the two latter features as well as by the greater size. A TEM picture of *P. recta*, identified as *Lauderiopsis costata*, is provided in Sundström (1986, Plate 39, Fig. 291). *Lauderiopsis costata* Ostenfeld was described with the ends of the numerous, very distinct bands forming “a slowly twined line” (Ostenfeld & Schmidt, 1901, p. 159) in contrast to the bands of *P. recta* being “hardly visible in water mounts” and with openings and ligulae forming “two opposite straight rows” (von Stosch, 1986, p. 313).

**Family Asterolampraceae** H. L. Smith 1872 emend. Gombos 1980

In the classification of Round et al. (1990) this family constitutes a separate order, Asterolamprales Round & Crawford, whereas Simonsen (1979) as well as Glezer et al. (1988) placed it in the order Centrales.



The family is characterized (Fig. 14) by “a partially areolated valve surface, which exhibits varying modes of development of hollow, hyaline rays that open to the interior of the valve by way of elongate slit-like openings and open to the exterior of the valve through holes at the marginal ends of the rays” (Gombos, 1980, p. 227). The hyaline rays extend from a hyaline (nonareolate) central area and terminate short of the valve margin in a labiate process (spine; apiculus in the older literature). The central area is traversed by a number of straight, zig-zaged, or branched lines termed umbilical lines (Greville, 1860) or separating lines (Gombos, 1980). Due to the raised hyaline rays the valve surface is radially undulated, and the cell is otherwise discoid with flat or slightly convex valves.

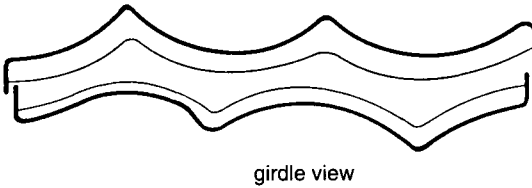

#### ASTEROMPHALUS

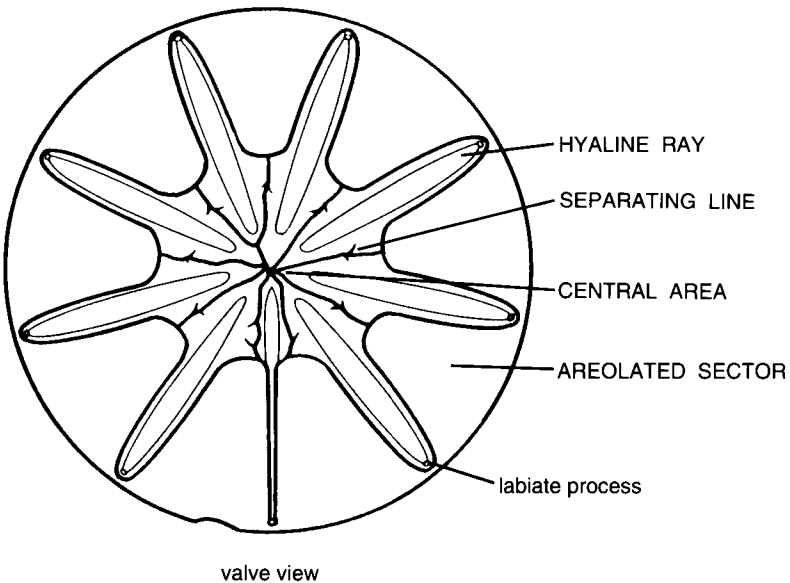

FIGURE 14 Schematic illustration of *Asteromphalus* sp. with terminology.

Two genera of this family have species represented in recent marine plankton.

### KEY TO GENERA

- 1a. All hyaline rays of the same shape and width. . . . . *Asterolampra*, p. 133  
 1b. One of the hyaline rays narrower than the others . . . . .  
 . . . . . *Asteromphalus*, p. 133

#### Genus *Asterolampra* Ehrenberg 1844 (Plate 23, Table 29)

**Lectotype:** *Asterolampra marylandica* Ehrenberg (*vide* Boyer, 1927, p. 71).

**Synonym:** *Asterolampra vanheurckii* Brun (*vide* Simonsen, 1974, p. 24).

**References:** Ehrenberg, 1844a, pp. 73 and 76; Ehrenberg, 1844c, Fig. 10; Greville, 1860, p. 113; Wallich, 1860, p. 47, Plate 2, Fig. 5; Brun, 1891, p. 10, Plate 14, Fig. 1; Hustedt, 1930, pp. 485 and 489, Figs. 270, 271 and 274; Cupp, 1943, p. 68, Fig. 31.

*Asterolampra grevillei* (Wallich) Greville and *A. marylandica* Ehrenberg are distinguished by the size of areolae and number of hyaline rays.

**Distribution:** Warm water region (e.g., Mediterranean, Indian Ocean, Gulf of California).

**How to identify:** The species may be identified in valve view in water mounts.

#### Genus *Asteromphalus* Ehrenberg 1844

**Lectotype:** *Asteromphalus darwinii* Ehrenberg (*vide* Boyer 1927, p. 72).

**References:** Ehrenberg, 1844b, pp. 198 and 200; Ehrenberg, 1844c, Figs. 1–7; Hernández-Becerril, 1991a.

The genus encompasses 10 or more species commonly recorded from marine plankton. This chapter deals with a few distinct species and describes them as they are seen with LM.

Characters showing differences between species:

- Valve outline (variable in some species).
- Number of hyaline rays (variable to a certain extent).
- Position of central area (centric or eccentric).
- Size of central area compared to valve diameter.
- Shape of separating lines.
- Shape of narrow hyaline ray within central area.
- Shape of areolated sectors.
- Size of areolae.

A. Valve outline oblong to elliptical: *A. flabellatus* and *A. sarcophagus* (Table 30).

*Asterolampra*

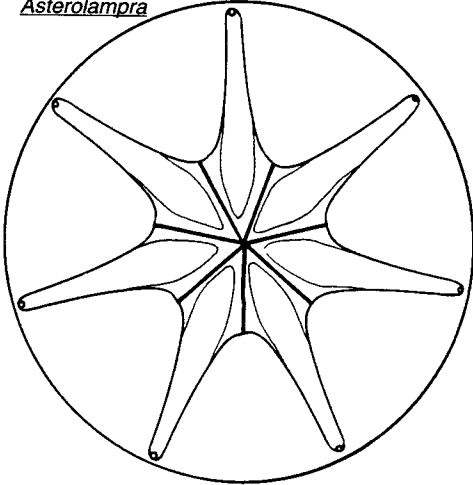

*A. marylandica*

*Asteromphalus*

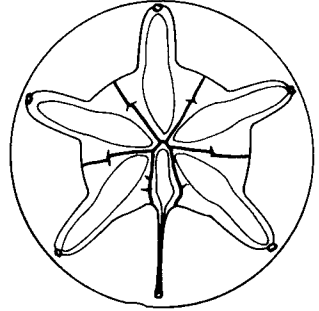

*A. parvulus*

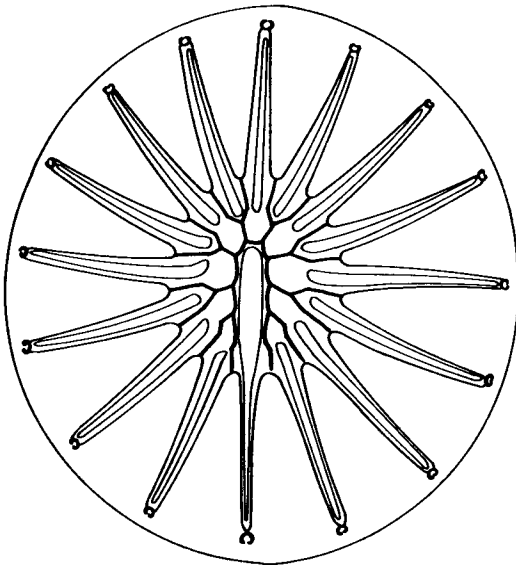

*A. elegans*

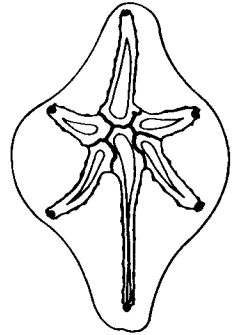

*A. sarcophagus*

PLATE 23 *Asterolampra marylandica*, *Asteromphalus parvulus*, *A. elegans*, and *A. sarcophagus*. Valves with hyaline rays. Scale bar = 10  $\mu$ m.

TABLE 29 Morphometric Data of *Asterolampra* spp. (Hustedt, 1930)

Species	Diameter (μm)	Valve areolae in 10 μm	No. of hyaline rays	Size of central area
<i>A. grevillei</i>	70–125	20–22	7–17 (13)	ca. 0.25 × Diameter
<i>A. marylandica</i>	50–150	13–17	4–12 (7)	0.17–0.33 × Diameter

Note. Numbers in parentheses are most common.

B. Valve outline broadly oval to circular: *A. arachne*, *A. elegans*, *A. heptactis*, *A. hookeri*, *A. hyalinus*, *A. parvulus*, and *A. roperianus* (Table 31).

A. Valve outline oblong to elliptical.

***Asteromphalus flabellatus*** (Brébisson) Greville (Plate 24, Table 30)

Basionym: *Spatangidium flabellatum* Brébisson.

References: Brébisson, 1857, p. 297, Plate 3, Fig. 3; Greville, 1859b, p. 160, Plate 7, Fig. 4; Hustedt, 1930, p. 498, Fig. 279; Hernández-Becerril, 1991a, p. 14, Plates 12 and 13.

Central area slightly eccentric. Separating lines straight. Extension of the narrow ray inside the central area rectangular to club shaped. The remaining hyaline rays straight or slightly curved and narrow. Areolated sectors narrow and curved toward valve center.

***Asteromphalus sarcophagus*** Wallich (Plate 23, Table 30)

References: Wallich, 1860, p. 47, Fig. 12; Taylor, 1967, p. 443, Plate 1, Fig. 6; Simonsen, 1974, p. 26, Plate 22, Figs. 3–6; Hernández-Becerril, 1991a, p. 30, Plates 32 and 33.

Valve outline varying from having slightly convex margins and one apex narrower than the other to having a lateral inflation more toward the end opposite the narrow hyaline ray giving the valve a pyriform shape. Central area often extremely eccentric with a narrow hyaline ray occupying about half the length of the valve. Two rays pointing to the same end of the valve as the narrow ray and curved with the concave side facing the valve margin. Areolae decreasing in size toward the narrow apex.

Distribution: *A. flabellatus*, and *A. sarcophagus*—warm water region (Simonsen, 1974).

*Asteromphalus**A. flabellatus**A. roperianus**A. heptactis*

PLATE 24 *Asteromphalus flabellatus*, *A. roperianus*, and *A. heptactis*. Valves with hyaline rays.  
Scale bar = 10  $\mu\text{m}$ .

TABLE 30 Morphometric Data of *Asteromphalus* spp. with Oblong to Elliptical Valve Outline

Species	Diameter ( $\mu\text{m}$ ) <sup>a</sup>		Sector areolae in 10 $\mu\text{m}$	No. of hyaline rays	Central area
	1	2			
<i>A. sarcophagus</i>	21–45	18–23	7–11	6	0.33–0.5 $\times$ diam.
<i>A. flabellatus</i>	40–60	24–50	16	7–11	0.4–0.6 $\times$ diam.

<sup>a</sup> Diameters 1 and 2, longer and shorter diameter of ellipse, respectively.

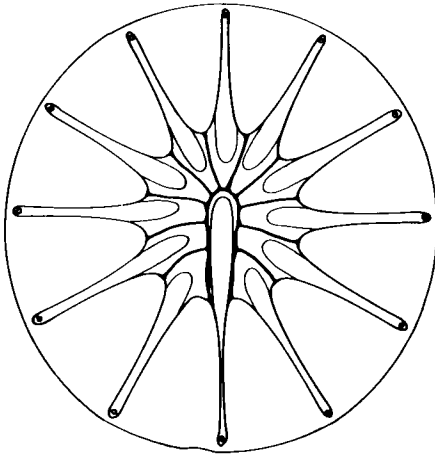
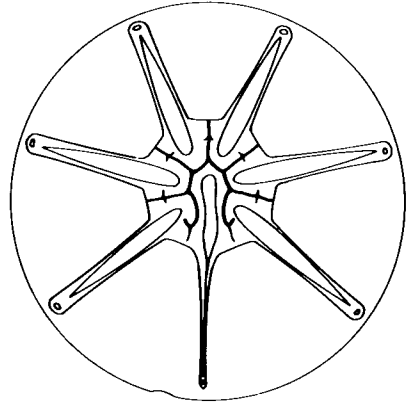
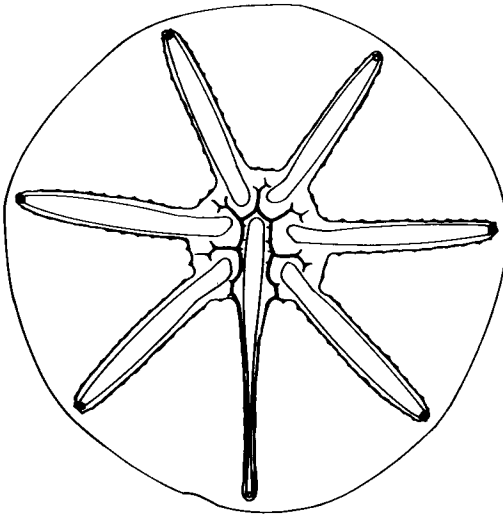
B. Valve outline broadly oval to circular.

***Asteromphalus arachne*** (Brébisson) Ralfs in Pritchard (Plate 25, Table 31)  
**Basionym:** *Spatangidium arachne* Brébisson.

**References:** Brébisson, 1857, p. 296, Plate 3, Fig. 1; Pritchard, 1861, p. 837, Plate 5, Fig. 66; Hustedt, 1930, p. 493, Fig. 276; Sournia, 1968, p. 25, Plate 9, Fig. 60; Hernández-Becerril, 1992a, p. 279, Figs. 1–14.

Central area eccentric, extremely small. Hyaline rays narrow, the two farthest away from the narrow ray curve away from the valve center.

***Asteromphalus elegans*** Greville (Plate 23, Table 31)

**References:** Greville, 1859b, p. 161, Plate 7, Fig. 6; Sournia, 1968, p. 24, Plate 9, Fig. 59; Hernández-Becerril, 1991a, p. 17, Plates 16 and 17.

Separating lines genuflexed and sometimes once or twice forked.

Extension of narrow hyaline ray inside the central area rectangular. Many hyaline rays. Finely areolated sectors, sharply truncated or somewhat pointed toward central area.

***Asteromphalus heptactis*** (Brébisson) Ralfs in Pritchard (Plate 24, Table 31)

**Basionym:** *Spatangidium heptactis* Brébisson.

**References:** Brébisson, 1857, p. 296, Plate 3, Fig. 2; Pritchard, 1861, p. 838, Plate 8, Fig. 21; Hustedt, 1930, p. 494, Fig. 277; Cupp, 1943, p. 69, Fig. 32; Hendey, 1964, p. 96, Plate 24, Fig. 5; Sournia, 1968, p. 25, Plate 9, Fig. 58; Hernández-Becerril, 1991a, p. 26, Plates 28 and 29.

Central area small compared to similar species. Separating lines bent or branched. Extension of narrow hyaline line inside the central area almost rectangular. Hyaline rays broad. Areolated sectors coarsely structured, truncated, and narrow (the width of three or four areolae) toward the central area.

*Asteromphalus*

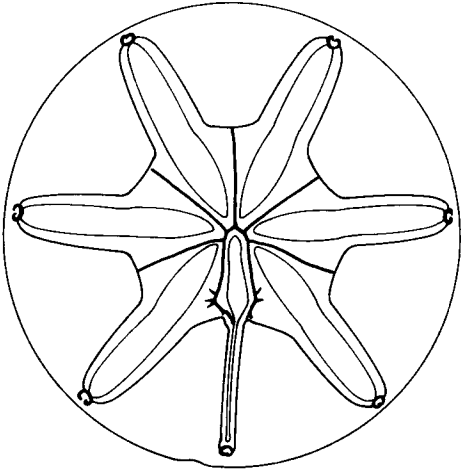

*A. hookeri*

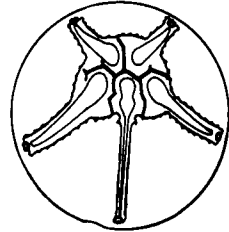
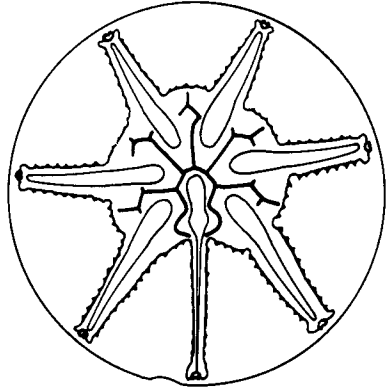

*A. hyalinus*

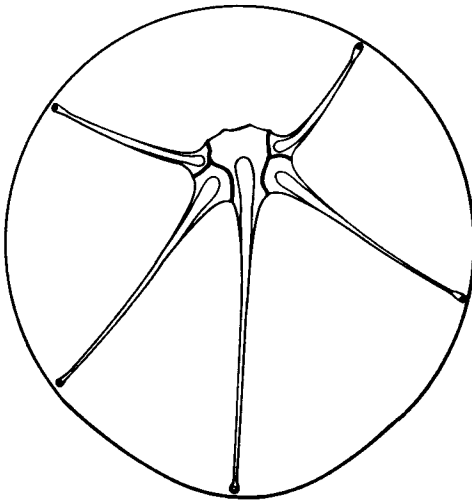

*A. arachne*

PLATE 25 *Asteromphalus hookeri*, *A. hyalinus*, and *A. arachne*. Valves with hyaline rays. Scale bar = 10  $\mu$ m.

***Asteromphalus bookeri* Ehrenberg (Plate 25, Table 31)**

References: Ehrenberg, 1844b, p. 200; Ehrenberg, 1844c, Fig. 3; Karsten, 1905, p. 90, Plate 8, Fig. 9; Hustedt, 1958a, p. 127, Figs. 88–90; Hernández-Becerril, 1991a, p. 23, Plates 24 and 25.

Separating lines straight. Extension of narrow hyaline ray rectangular or bell shaped. Areolated sectors wedge shaped and curved toward valve center.

***Asteromphalus hyalinus* Karsten (Plate 25, Table 31)**

References: Karsten, 1905, p. 90, Plate 8, Fig. 15; Hustedt, 1958a, p. 128, Figs. 84–87.

Small. Central area large and more or less eccentric with convex margins toward wide areolated sectors (six to nine areolae between the hyaline rays). Separating lines genuflexed and branched. Extension of narrow hyaline ray inside central area wide at base with sudden constriction closer to valve center. Hyaline rays few and often slightly curved.

***Asteromphalus parvulus* Karsten (Plate 23, Table 31)**

References: Karsten, 1905, p. 90, Plate 8, Fig. 14; Hustedt, 1958a, p. 128, Fig. 91.

Large central area. Separating lines broken. Areolated sectors coarsely structured and convex toward valve center.

***Asteromphalus roperianus* (Greville) Ralfs in Pritchard (Plate 24, Table 31)**

Basionym: *Asterolampra roperiana* Greville.

References: Greville, 1860, p. 120, Plate 4, Fig. 14; Pritchard, 1861, p. 838; Sournia, 1968, p. 26, Plate 9, Fig. 61; Simonsen, 1974, p. 26, Plate 22, Fig. 2; Hernández-Becerril, 1991a, p. 21, Plates 22 and 23.

TABLE 31 Morphometric Data of *Asteromphalus* spp. with Broadly Oval to Circular Valve Outline

Species	Diameter (µm)	Sector areolae in 10 µm	No. of hyaline rays	Size of central area
<i>A. arachne</i>	40–60	7–8	5	0.17–0.14 × diam.
<i>A. elegans</i>	100–180	15–20 ? <sup>b</sup>	11–26	0.33 × diam.
<i>A. heptactis</i>	42–175	5–7	7	0.25–0.33 × diam.
<i>A. hookeri</i>	25–60	5–9 ?	6–9	0.33–0.50 × diam.
<i>A. hyalinus</i>	15–32	8–12	3–5	0.50 × diam.
<i>A. parvulus</i>	22–48	8–10	6	0.50–0.75 × diam.
<i>A. roperianus</i>	80–120	9–11	7	0.33 × diam.

<sup>b</sup> ar. = areolae; ?, data uncertain.



Central area comparatively small. Separating lines obscurely bent and sometimes equipped with small branches in the middle. Extension of narrow hyaline ray inside central area conspicuous in shape being semicircular at the top, then contracted, and widely expanded. Areolated sectors moderately wide (six or seven areolae between two hyaline rays) and truncated toward valve center.

**Distribution:**

*A. arachne*, *A. elegans*, and *A. roperianus*—warm water region (Simonsen, 1974).

*A. heptactis*—temperate [Davis Strait—Cape of Good Hope (Hendey, 1964)].

*A. hookeri*, *A. hyalinus*, and *A. parvulus*—southern cold water region (Hustedt, 1958a).

**How to identify:** Examinations of cells in valve view, whole cells, or single valves are required for identification purposes. Water mounts may be sufficient in some cases; permanent mounts of cleaned material are recommended.

**Remarks:** Special distributional as well as taxonomic problems connected with the three species classified as Antarctic (southern cold water region) should be noted. *Asteromphalus hookeri* has been reported as common in north temperate waters (Hendey, 1964), and our own observations indicate that the species described by Karsten (1905) as *A. hyalinus* may be present in the Norwegian and the Barents Seas as well as in the North Pacific. Examination of Antarctic material showed that *A. parvulus* and larger specimens of *A. hyalinus* are not readily distinguished, and a comparison with Ehrenberg's (1844c) illustrations of *A. darwinii* and *A. rossii* indicates a possible conspecificity between these four species. Hernández-Becerril (1991a, 1992a) provided detailed information on the valve structure seen with SEM and on the taxonomy and biogeography of the genus (information that has not been included in this chapter). It should be noted, however, that *A. sarcophagus* was placed in the subgenus *Liriogramma* (Kolbe) Hernández-Becerril, and that reinstatement of the genus *Spatangidium* Brébisson with *S. arachne* as the type was suggested.

**Family Heliopeltaceae** H. L. Smith 1872

Glezer et al. (1988) and Simonsen (1979) regarded *Actinoptychus* as well as *Aulacodiscus* as members of this family. Round et al. (1990) put *Aulacodiscus* Ehrenberg in the family Aulacodiscaceae (Schütt) Lemmermann and retained *Actinoptychus* Ehrenberg in Heliopeltaceae. The two genera are primarily benthic. Two species are often recorded from plankton and are included here.

***Actinoptychus senarius*** (Ehrenberg) Ehrenberg (Plate 22)**Basionym:** *Actinocyclus senarius* Ehrenberg.**Synonym:** *Actinoptychus undulatus* (Bailey) Ralfs in Pritchard.**References:** Ehrenberg, 1838, p. 172, Plate 21, Fig. 6; Ehrenberg, 1843, p. 400, Plate 1,1, Fig. 27, Plate 1,3, Fig. 21; Pritchard, 1861, p. 839, Plate 5, Fig. 88; Hustedt, 1930, p. 475, Fig. 264; Cupp, 1943, p. 67, Fig. 29, Plate 5, Fig. 1; Hendeby, 1964, p. 95, Plate 23, Figs. 1 and 2; Takano, 1990, pp. 258–259.

Cells disc shaped with valves divided into sectors, usually six, alternately raised and depressed. A central nonareolated area, hexagonal in outline.

Each of the raised sectors with a labiate process with an external tube.

Areolation coarse and irregular. Chloroplasts large and numerous.

**Morphometric data:** Diameter, 20–150  $\mu\text{m}$ ; areolae, four to seven in 10  $\mu\text{m}$ .**Distribution:** Cosmopolitan?***Aulacodiscus argus*** (Ehrenberg) A. Schmidt**Basionym:** *Tripodiscus argus* Ehrenberg.**References:** Ehrenberg, 1844a, p. 73; Schmidt, 1886, Plate 107, Fig. 4; Hustedt, 1930, p. 503, Fig. 281.

Cells box shaped with flat or slightly convex valves. Valve structure complex and dense consisting of one layer with angular areolae overlying a layer with finer pores. Three to six marginal labiate processes with prominent pear-shaped extensions raised above valve surface. Chloroplasts fairly large and roundish.

**Morphometric data:** Diameter, 80–260  $\mu\text{m}$ ; areolae, four to six in 10  $\mu\text{m}$ .**Distribution:** Cosmopolitan?**How to identify:** The species may be identified in valve view in water mounts or, in critical cases, as valves cleaned of organic matter and mounted in a medium not necessarily of a high refractive index.**Suborder Rhizosoleniineae****Family Rhizosoleniaceae** Petit 1888*Dactyliosolen*, *Guinardia*, and *Rhizosolenia* are the recent, marine, planktonic genera of this family as circumscribed by Simonsen (1979) and Glezer et al. (1988); Round et al. (1990) included the more recently described genera *Proboscia*, *Pseudosolenia*, and *Urosolenia*. In the latter classification Rhizosoleniaceae was placed in the order Rhizosoleniales P. Silva in the new subclass Rhizosoleniophycidae Round & Crawford.Sundström (1986) stressed the necessity of splitting Rhizosoleniaceae and establishing new families since he found that his circumscription of *Rhizosolenia*, the type of the family, comprised species that differed considerably from

those in *Guinardia* and *Dactyliosolen*. He suggested that Rhizosoleniaceae should be confined to *Rhizosolenia* Brightwell, *Pseudosolenia* Sundström, and possibly *Proboscia* Sundström. However, no new families were described.

For a lack of better alternatives this chapter will deal with the heterogeneous family Rhizosoleniaceae *sensu lato* comprising *Proboscia*, *Pseudosolenia*, *Rhizosolenia sensu lato*, *Guinardia*, and *Dactyliosolen*. Most of the data and information on *Rhizosolenia sensu stricto*, *Pseudosolenia*, and *Proboscia* are from Sundström (1986). *Rhizosolenia* and *Proboscia* species present in polar regions are dealt with specifically by Priddle et al. (1990).

Characters of Rhizosoleniaceae *sensu lato*:

Cells in chains.

Cells cylindrical.

A single process with internal labiate, sometimes more tubular structure.

Unipolar valve symmetry.

Numerous small chloroplasts.

Resting spores seldom.

Terminology specific to Rhizosoleniaceae (mainly after Sundström, 1986) (Fig. 15):

**Contiguous area**—part of the ventral side of the valve contiguous with the adjacent valve of linked cells, usually delimited by low marginal ridges.

**Claspers**—pair of membranous structures usually continuous with marginal ridges of contiguous area clasping otaria of the adjacent valve of linked cells. In *Proboscia* the structures clasping the distal part of the proboscis of linked cells.

**Otarium**—one of the pair of membranous costae that occur opposite each other at or near the base of the external process, previously called a wing.

**Proboscis**—elongated part of the valve with truncate tip; the distal part fits into a groove on the adjacent valve of linked cells.

**Segment—band—copula**—single element of the girdle.

#### KEY TO GENERA

- 1a. Valves conical to subconical, girdle segments (bands) generally with loculate areolae (SEM) . . . . . 2
- 1b. Valves flat or rounded, girdle segments (bands) with poroid areolae (SEM) . . . . . 4
- 2a. Valves with an external process . . . . . 3
- 2b. Valves with a proboscis and no process . . . . . *Proboscia*, p. 159

RHIZOSOLENIA

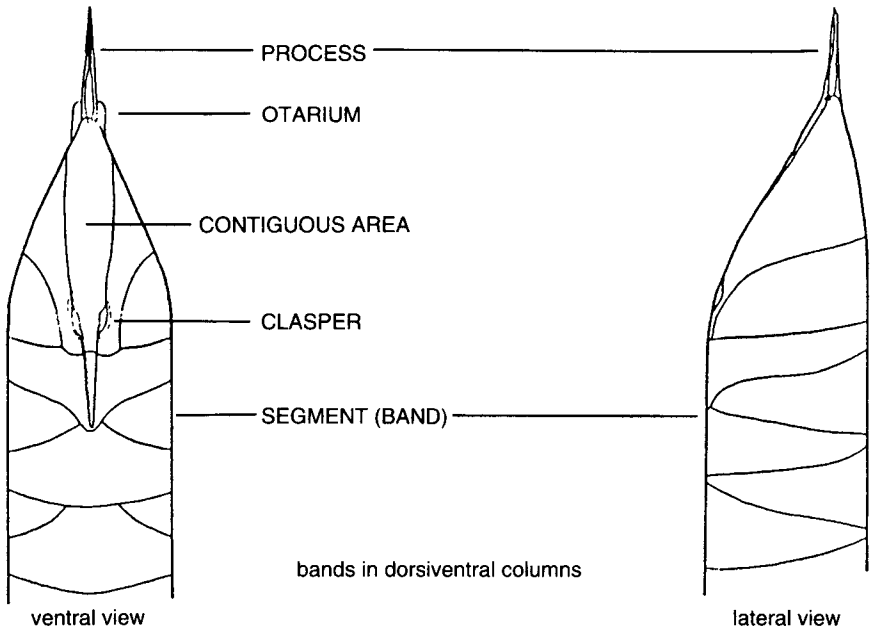

Section RHIZOSOLENIA

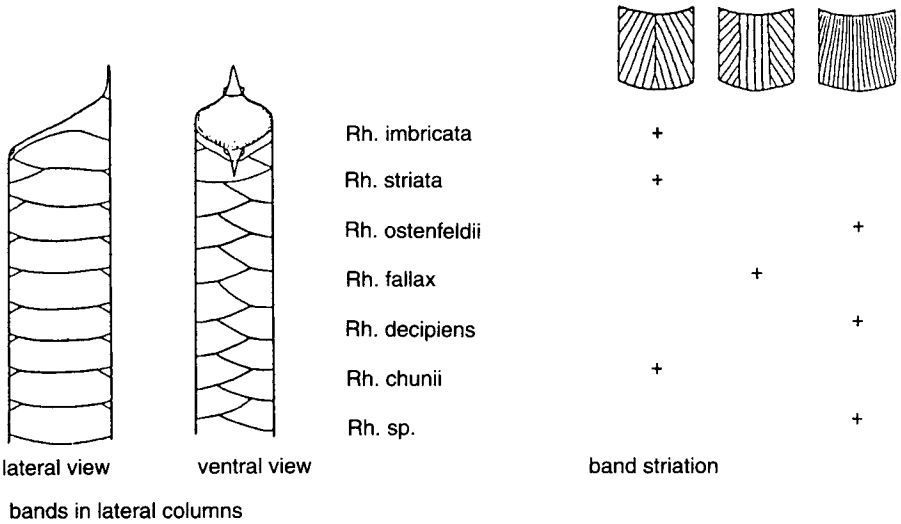

Section IMBRICATAE

FIGURE 15 Schematic illustrations of *Rhizosolenia* spp. with terminology and type of band striation for the section *Imbricatae*.

- 3a. Valves regular conical, process straight, generally with otaria . . . . .  
 . . . . . *Rhizosolenia sensu stricto*, p. 144
- 3b. Valves irregular subconical, process claw like with no otaria . . . . .  
 . . . . . *Pseudosolenia*, p. 160
- 4a. Girdle composed of open (split) bands with ligulae and antiligulae . . . .  
 . . . . . *Guinardia*, p. 160
- 4b. Girdle composed of half bands . . . . . *Dactyliosolen*, p. 165

**Genus *Rhizosolenia* Brightwell 1858**

**Type:** *Rhizosolenia styliformis* Brightwell.

Valves conoidal; otaria and claspers usually present; apex characteristically terminated by one process which opens at the tip and communicates with the cell interior by a labiate structure. Areolae of copulae usually loculate (EM). For the complete diagnosis see Sundström (1986, p. 106).

The *Rhizosolenia* girdle is composed of numerous segments (bands, copulae) in two or several longitudinal columns. The outline of the copulae is scale like to trapezoid to rhomboidal to wing shaped, partly depending on the width of the cell and the number of columns. There is only one, seldom two (in the larger species), valvocopulae. The valvocopula is thus larger and differs in shape from the other copulae (e.g., *R. acicularis*, Plate 26).

Characters showing differences between species:

- Segments (bands) in dorsiventral or lateral columns.
- Number of columns of segments.
- Shape of valve and process.
- Otaria: position, extension, size, and shape.
- Labiate structure visible or not with LM.

The genus is divided into two sections. A further grouping of the species may be based on the characters mentioned previously.

A. Section *Rhizosolenia*: Girdle segments (copulae, bands) in two dorsiventral columns or in several columns.

1. Two columns of segments; otaria, claspers, and labiate structure present (LM observations).
  - a. Otaria ending at base of process: *R. styliformis* and *R. formosa* (Table 32).
  - b. Otaria confined to valve proper, not extending to the base of the process: *R. curvata* and *R. acicularis* (Table 32).
  - c. Otaria along basal part of process: *R. borealis* (Table 32).
2. Two columns of segments, otaria and claspers present or absent; labiate structure (LM observations) present; dimorphism: *R. antennata*, *R. hebetata*, *R. polydactyla*, and *R. sima* (Table 33).

*Rhizosolenia*

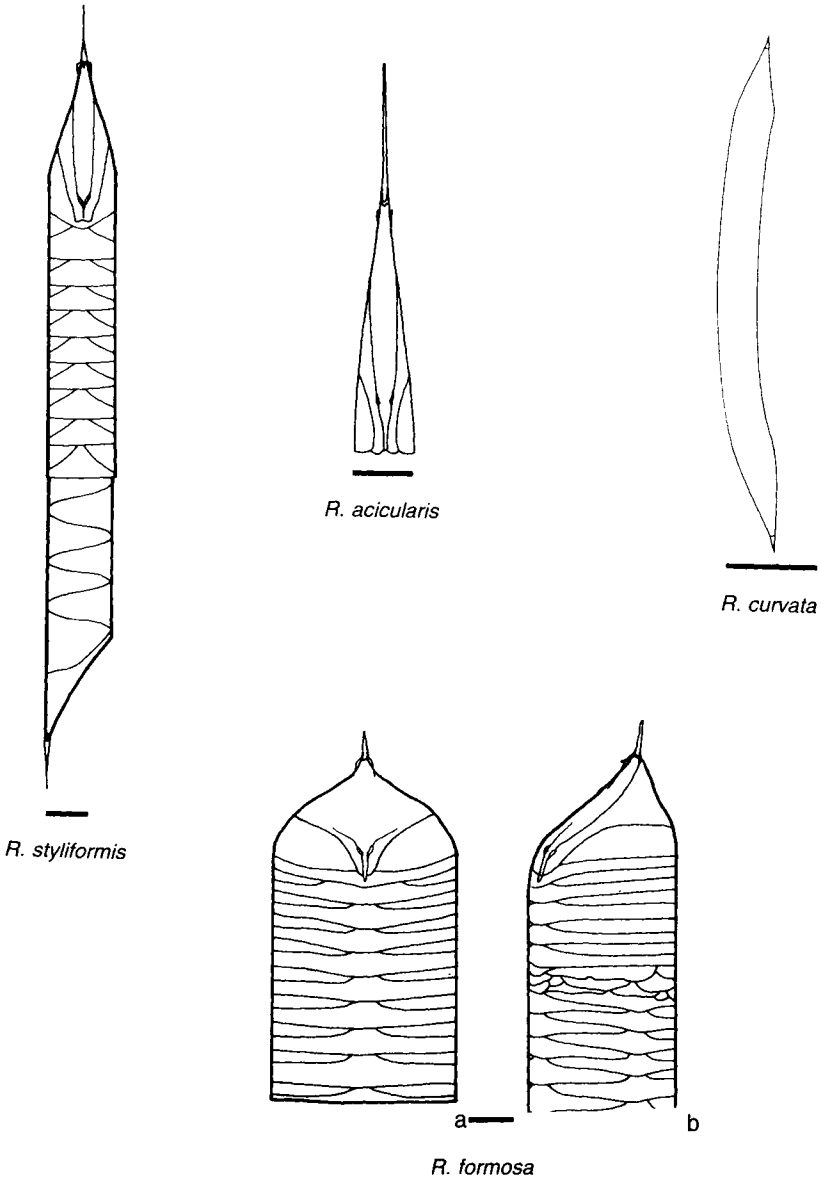

PLATE 26 *Rhizosolenia styliformis*: epitheca in ventral and hypotheca in lateral view. Otaria and claspers evident on epitheca. Scale bar = 20  $\mu\text{m}$ . *Rhizosolenia acicularis*: valve with valvocopula, ventral view. After Sundström (1986). Scale bar = 50  $\mu\text{m}$ . *Rhizosolenia curvata*: lateral view. From Hasle, 1968b. Scale bar = 50  $\mu\text{m}$ . *Rhizosolenia formosa*: (a) ventral view; (b) lateral view. After Sundström (1986). Scale bar = 50  $\mu\text{m}$ .

3. More than two columns of segments—labiate structure present (LM observations).
- a. Otaria and claspers present: *R. crassa*, *R. clevei*, *R. hyalina*, *R. castracanei*, and *R. debyana* (Table 34).
  - b. Otaria and claspers lacking: *R. temperei*, *R. acuminata*, *R. bergonii*, and *R. simplex* (Table 34).
- B. Section *Imbricatae*: Girdle segments (copulae, bands) in two lateral columns; otaria, claspers (LM), and labiate structure (EM) present: *R. imbricata*, *R. ostefeldii*, *R. fallax*, *R. striata*, and *R. decipiens* (Table 35).
- C. *Incertae sedis* (*Rhizosolenia*): *R. setigera*, *R. pungens*, and *R. robusta*.
- A. Section *Rhizosolenia*.
1. Two dorsiventral columns of segments; no dimorphism.

***Rhizosolenia styliformis*** Brightwell (Plate 26, Table 32)

Synonym: *R. styliformis* var. *longispina* Hustedt in A. Schmidt.

References: Brightwell, 1858a, p. 94, Plate 5, Figs. 5a–5e; Schmidt, 1914, Plate 316, Figs. 5–7 and 12; Hustedt, 1930, p. 586, Fig. 334; Hasle, 1975, Figs. 1–3; Sundström, 1986, p. 15, Figs. 5 and 47–56.

Otaria sometimes ending below the process base and sometimes extending a short distance along the basal part of the process.

***Rhizosolenia formosa*** H. Peragallo (Plate 26, Table 32)

Synonym: *R. styliformis* f. *latissima* “Brightwell” in H. Peragallo.

References: Peragallo, 1888, p. 83, Plate 6, Fig. 43; Sundström, 1986, p. 33, Figs. 12, 13, 88–93, and 96–99.

TABLE 32 Morphometric Data of *Rhizosolenia* spp. with Two Columns of Segments and No Dimorphism

Species	Diameter (μm)	Length of process (μm)	Band areolae in 10 μm	Valve areolae in 10 μm <sup>a</sup>
<i>R. styliformis</i>	23–90	30–50	20–21	27–28
<i>R. formosa</i>	80–230	17–30	18–19	22–25
<i>R. curvata</i>	30–95	— <sup>b</sup>	20	—
<i>R. acicularis</i>	13–40	up to 50	20–21	—
<i>R. borealis</i>	13–65	15–28	15–17	22–24

<sup>a</sup> Measured with TEM.

<sup>b</sup> —, No data.

Bands “low.” Apex shallow. Otaria sometimes ending slightly below the process base and sometimes extending a short distance along the basal part of the process.

***Rhizosolenia curvata* Zacharias (Plate 26, Table 32)**

**Synonym:** *Rhizosolenia curva* Karsten.

**References:** Zacharias, 1905, p. 120; Karsten, 1905, p. 97, Plate 11, Fig. 2; Hasle, 1968b, p. 7, Plate 9, Fig. 8, Map 2; Sournia et al., 1979, p. 191, Fig. 20; Sundström, 1986, p. 20, Figs. 57–63; Priddle et al., 1990, p. 118, Plate 15.2, Fig. 3.

Cells curved. Otaria comparatively small, ending below valve apex.

***Rhizosolenia acicularis* Sundström (Plate 26, Table 32)**

**Reference:** Sundström 1986, p. 22, Figs. 6 and 64–69.

Otaria pointed, narrow, ending below process base. Perhaps closely related to *R. styliformis* but differs in shape and position of otaria and in distribution.

***Rhizosolenia borealis* Sundström (Plate 27, Table 32)**

**Synonym:** *Rhizosolenia styliformis* var. *oceanica* Wimpenny *pro parte*.

**References:** Wimpenny, 1946, p. 279, Text Fig. 1d; Hasle, 1975, p. 104, Figs. 8–20; Sundström, 1986, p. 30, Figs. 10, 11, and 80–87.

Otaria extending to about half the length of the thicker basal part of the process.

**Remarks:** The reasons for regarding *R. borealis* and *R. polydactyla* as two distinct species are the difference in the distribution and the fact that *R. polydactyla* is dimorphic and *R. borealis* is not (Sundström, 1986, p. 32).

**Distribution:**

*R. borealis*—northern cold water region.

*R. styliformis*—northern part of North Atlantic Ocean.

*R. acicularis* and *R. formosa*—warm water region.

*R. curvata*—Subantarctic/Antarctic convergence.

2. Two dorsiventral columns of segments: dimorphism.

***Rhizosolenia antennata* (Ehrenberg) Brown f. *antennata* (Plate 27, Table 33)**

**Basionym:** *Dicladia antennata* Ehrenberg.

**Synonyms:** *Rhizosolenia bidens* Karsten *pro parte*; *Rhizosolenia hebetata* f. *bidens* Heiden in Heiden & Kolbe.

**References:** Ehrenberg, 1844b, p. 201; Karsten, 1905, p. 98, Plate 9, Fig. 13; Van Heurck, 1909, Plate 4, Fig. 64; Brown, 1920, p. 233, Fig. 8; Heiden & Kolbe, 1928, p. 519, Figs. 158–161; Sundström, 1986, p. 42, Figs. 115, 119, and 120; Priddle et al., 1990, p. 117, Plate 15.1, Figs. 5a–5c.

Two processes, no otaria.



*Rhizosolenia*

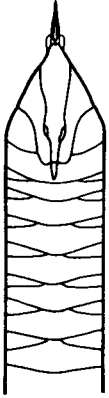

*R. borealis*

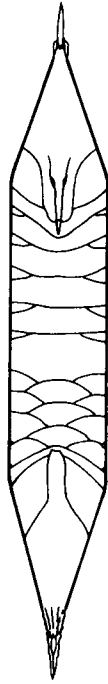

f. *polydactyla*

f. *squamosa*

*R. polydactyla*



*R. antennata*  
f. *antennata*

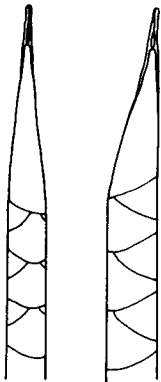

*R. hebetata*  
f. *hebetata*



*R. hebetata*  
f. *semispina*

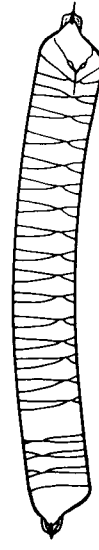

*R. sima*  
f. *sima*



*R. sima*  
f. *silicea*

TABLE 33 Morphometric Data of *Rhizosolenia* spp. with Two Columns of Segments and Dimorphism

Species	Diameter ( $\mu\text{m}$ )	Length of process ( $\mu\text{m}$ )	Band areolae in 10 $\mu\text{m}$
<i>R. antennata</i> f. <i>antennata</i>	18–45	30–80	23–26
<i>R. antennata</i> f. <i>semispina</i>	6.5–42	— <sup>a</sup>	—
<i>R. hebetata</i> f. <i>hebetata</i>	15–44	15–25	—
<i>R. hebetata</i> f. <i>semispina</i>	4.5–25	—	28–30
<i>R. polydactyla</i>	15–105	18–34	20–23 <sup>b</sup>
<i>R. sima</i> f. <i>sima</i>	12–39	—	31–36
<i>R. sima</i> f. <i>silicea</i>	18–40	—	30

<sup>a</sup> —, No data.

<sup>b</sup> *R. polydactyla* 26–28 valve areolae in 10  $\mu\text{m}$ , measured with TEM, information on the other species missing.

***Rhizosolenia antennata* f. *semispina* Sundström (Table 33)**

Commonly identified as *Rhizosolenia hebetata* f. *semispina*.

Reference: Sundström, 1986, p. 44, Figs. 20, 114, and 116–118.

Pointed otaria extending at least 3  $\mu\text{m}$  along the basal part of the process.

***Rhizosolenia hebetata* Bailey f. *hebetata* (Plate 27, Table 33)**

Synonym: *Rhizosolenia hebetata* f. *hiemalis* Gran.

References: Bailey, 1856, p. 5, Plate 1, Figs. 18 and 19; Gran, 1904, pp. 524–527, Plate 27, Figs. 9 and 10; Hustedt, 1930, p. 590, Fig. 337; Cupp, 1943, p. 88, Fig. 50a; Drebes, 1974, p. 56, Fig. 41; Sundström, 1986, p. 47, Figs. 18, 112, and 113.

Process heavily silicified, no otaria.

***Rhizosolenia hebetata* f. *semispina* (Hensen) Gran (Plate 27, Table 33)**

Basionym: *Rhizosolenia semispina* Hensen.

PLATE 27 *Rhizosolenia borealis*: ventral view. Scale bar = 50  $\mu\text{m}$ . *Rhizosolenia polydactyla*: upper theca f. *polydactyla* and the lower theca f. *squamosa*. Scale bar = 50  $\mu\text{m}$ . *Rhizosolenia antennata* f. *antennata*: Scale bar = 20  $\mu\text{m}$ . *Rhizosolenia hebetata*: f. *hebetata*: (a) ventral and (b) lateral view. Scale bar = 20  $\mu\text{m}$ . *Rhizosolenia hebetata* f. *semispina*: ventral view. Scale bar = 20  $\mu\text{m}$ . *Rhizosolenia sima* f. *sima*: ventral view. Scale bar = 50  $\mu\text{m}$ . *Rhizosolenia sima* f. *silicea*: ventral view. Scale bar = 50  $\mu\text{m}$ . All figures after Sundström (1986).

**References:** Hensen, 1887, p. 84, Plate 5, Fig. 39; Gran, 1904, Plate 27, Figs. 11 and 12; Sundström, 1986, p. 48, Figs. 19, 20, 114, and 116–118.

Pointed otaria extending at least 3  $\mu\text{m}$  along the basal part of the process.

**Remarks:** Although *R. antennata* f. *semispina* and *R. hebetata* f. *semispina* are almost indistinguishable with both LM and EM, Sundström (1986) regarded the species as separate taxa because of the widely different distribution and the great morphological dissimilarity between their nominate forms.

***Rhizosolenia polydactyla*** Castracane f. *polydactyla* (Plate 27, Table 33)

**Synonym:** *Rhizosolenia styliformis* var. *oceanica* Wimpenny *pro parte*.

**References:** Castracane, 1886, p. 71, Plate 24, Fig. 2; Wimpenny, 1946, p. 279, Text Fig. 1e; Sundström, 1986, p. 24, Figs. 7–9, 70–73, 74, 76, 77, and 79.

Otaria extending to about half the length of the thicker basal part of the process.

***Rhizosolenia polydactyla*** f. *squamosa* Sundström

**Reference:** Sundström, 1986, p. 26, Figs. 8, 9, 73, 75, and 78.

Bands in two or a multiple of two columns. Process coarsely structured; otaria lacking. “Exogenous resting spore” of f. *polydactyla*?

***Rhizosolenia sima*** Castracane f. *sima* (Plate 27, Table 33)

**References:** Castracane, 1886, p. 71, Plate 24, Fig. 11; Van Heurck, 1909, Plate 4, Fig. 70; Sundström, 1986, p. 62, Figs. 28 and 144–149.

Process basal part bulbous; distal tube thin walled. Otaria large, extending along the basal part of the process.

***Rhizosolenia sima*** f. *silicea* Sundström (Plate 27, Table 33)

**References:** Van Heurck, 1909, Plate 4, Fig. 71; Sundström, 1986, p. 63, Figs. 29 and 150–154.

Process heavily silicified, usually with uneven longitudinal ridges; no otaria. “Resting spore” of f. *sima*?

**Distribution:**

*R. antennata*, *R. polydactyla*, and *R. sima*—southern cold water region.  
*R. hebetata*—northern cold water region.

3. More than two columns of segments.

***Rhizosolenia crassa*** Schimper in Karsten (Plate 28, Table 34)

**References:** Karsten, 1905, p. 99, Plate 11, Fig. 6; Sundström, 1986, p. 59, Figs. 26, 27, and 139–143.

Two and four columns of bands within a single cell. Otaria prominent, bordering valve apex and basal part of process; distal margin concave.

***Rhizosolenia clevei* Ostenfeld var. *clevei* (Plate 28, Table 34)**

References: Ostenfeld, 1902, p. 229, Fig. 6; Sournia, 1968, p. 78, Plate 10, Fig. 68; Sundström, 1984, p. 348, Figs. 1 and 4–9; Sundström, 1986, p. 53, Figs. 21, 121, 122, and 125.

Otaria arising at valve apex, extending along the basal part of the process. Host for the blue-green *Richelia intracellularis*.

***Rhizosolenia clevei* var. *communis* Sundström (Plate 28, Table 34)**

References: Sundström, 1984, p. 348, Figs. 2, 3, and 10–15; Sundström, 1986, p. 54, Figs. 22, 23, 123, 124, 126, and 127.

Bands in two columns, otherwise as the nominate variety.

***Rhizosolenia hyalina* Ostenfeld in Ostenfeld & Schmidt.  
(Plate 28, Table 34)**

Synonym: *Rhizosolenia pellucida* Cleve.

References: Cleve, 1901a, p. 56, Plate 8, Fig. 4; Ostenfeld & Schmidt, 1901, p. 160, Fig. 11; Sournia, 1968, p. 79, Plate 3, Fig. 19; Sundström, 1986, p. 76, Figs. 34 and 190–194.

Process slightly bent near the end of the otaria. Otaria narrow, extending along process for ca. 4–6  $\mu\text{m}$ .

***Rhizosolenia castracanei* H. Peragallo var. *castracanei* (Plate 28, Table 34)**

References: Peragallo, 1888, p. 83, Plate 6, Fig. 42; Cupp, 1943, p. 94, Fig. 54; Sundström, 1986, p. 37, Figs. 15, 16, 102–104, and 108–111.

Bands coarsely structured. Valve apex shallow. Otaria confined to valve proper.

***Rhizosolenia castracanei* var. *neglecta* Sundström (Plate 28, Table 34)**

Reference: Sundström, 1986, p. 39, Figs. 17 and 105–107.

Bands in two columns. Valves of narrow cells similar to those of *R. styliformis*.

***Rhizosolenia debyana* H. Peragallo (Plate 28, Table 34)**

References: Peragallo, 1892, p. 111, Plate 2, Figs. 7 and 7a; Sundström, 1986, p. 57, Figs. 24, 25, and 128–138.

Valve and otaria similar in shape to those of *R. castracanei* var. *castracanei*; band areolae smaller.

Remarks: The number of columns of segments and the size of cell diameter are related to a certain extent. In *Rhizosolenia crassa* two columns of segments were observed in cells of all sizes and four columns in cells of 115–140  $\mu\text{m}$  in diameter but not in the narrower ones.

***Rhizosolenia temperei* H. Peragallo (Plate 29, Table 34)**

References: Peragallo, 1888, p. 83, Plate 5, Fig. 40; Hustedt, 1930, p. 605, Fig. 349; Sundström, 1986, p. 66, Figs. 30 and 155–163.

Valve contour sigmoid. Distal part of valve abruptly narrowed. No otaria.

*Rhizosolenia*

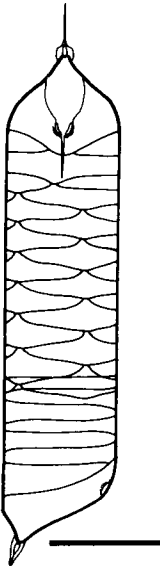

*R. crassa*

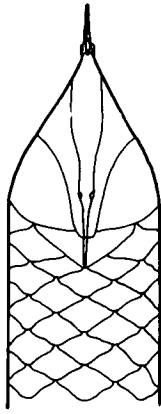

*R. clevei*  
var. *clevei*



*R. clevei*  
var. *communis*



*R. hyalina*



*R. castracanei*  
var. *neglecta*

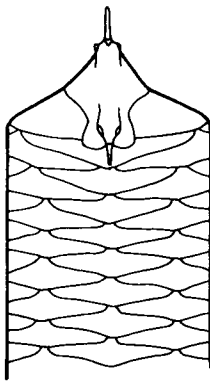

*R. castracanei*  
var. *castracanei*

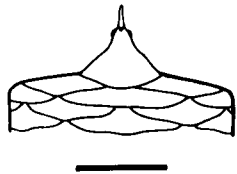
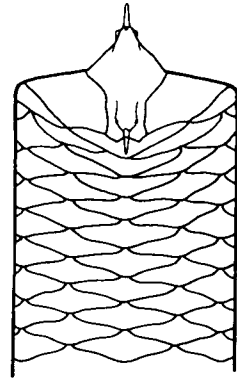

*R. debyana*

TABLE 34 Morphometric Data of *Rhizosolenia* spp. with More Than Two Columns of Segments

Species	Diameter ( $\mu\text{m}$ )	Length of process ( $\mu\text{m}$ )	Band areolae in 10 $\mu\text{m}^a$	Valve areolae in 10 $\mu\text{m}^b$
Otaria present				
<i>R. crassa</i>	100–165	ca. 50	22–24	27
<i>R. clevei</i>				
var. <i>clevei</i>	80–250	—	—	—
var. <i>communis</i>	7–55	—	19–25	—
<i>R. hyalina</i>	9–60	up to 40	31–36	—
<i>R. castracanei</i>				
var. <i>castracanei</i>	108–250	25–35	9–12	ca. 24
var. <i>neglecta</i>	14–127	—	10–13	—
<i>R. debyana</i>	180–310	Short	19–22	20–26
Otaria absent				
<i>R. temperi</i>	125–278	10–30	20–21	16–18
<i>R. acuminata</i>	50–190	10–40	18–22	—
<i>R. bergonii</i>	9–115	10–20	19–24	—
<i>R. simplex</i>	5–48	15–20	30–33	24–28

<sup>a</sup> Measured with TEM.

<sup>b</sup> Areolae measured with TEM, except those on the bands of *Rhizosolenia castracanei* and *R. temperi*.

***Rhizosolenia acuminata*** (H. Peragallo) H. Peragallo in H. & M. Peragallo (Plate 29, Table 34)

**Basionym:** *Rhizosolenia temperei* var. *acuminata* H. Peragallo.

**References:** Peragallo, 1892, p. 110, Plate 2, Fig. 4; H. & M. Peragallo, 1897–1908, p. 463, Plate 123, Figs. 7 and 8; Hustedt, 1930, p. 605, Fig. 350; Cupp, 1943, p. 94, Fig. 53; Sundström, 1986, p. 69, Figs. 31 and 165–176.

Valve and valvocopula deeply conical; distal part usually slightly narrowed. No otaria.

**PLATE 28** *Rhizosolenia crassa*: epitheca in ventral view, hypotheca in lateral view. Scale bar = 100  $\mu\text{m}$ . *Rhizosolenia clevei* var. *clevei*: part of theca with many rows of segments. Scale bar = 100  $\mu\text{m}$ . *Rhizosolenia clevei* var. *communis*: part of theca with two columns of segments. Scale bar = 20  $\mu\text{m}$ . *Rhizosolenia hyalina*: parts of thecae in ventral and lateral view. Scale bar = 20  $\mu\text{m}$ . *Rhizosolenia castracanei* var. *neglecta*: two dorsiventral columns of segments. Scale bar = 20  $\mu\text{m}$ . *Rhizosolenia castracanei* var. *castracanei*: many columns of segments. Scale bar = 100  $\mu\text{m}$ . *Rhizosolenia debyana*: upper partial theca in ventral and lower part in dorsal view. Scale bar = 100  $\mu\text{m}$ . All figures after Sundström (1986).

*Rhizosolenia*

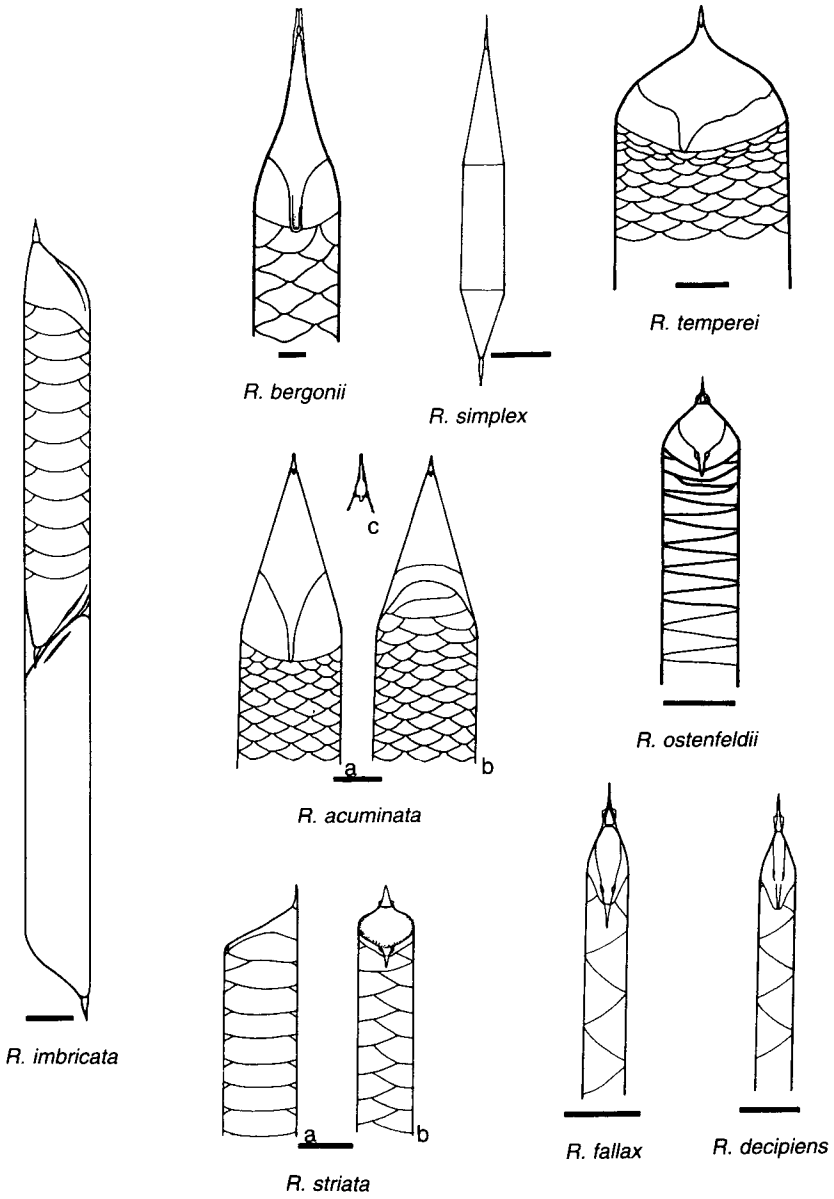

***Rhizosolenia bergonii*** H. Peragallo (Plate 29, Table 34)

References: Peragallo, 1892, p. 110, Plate 2, Fig. 5; Hustedt, 1930, p. 575, Fig. 327; Cupp, 1943, p. 81, Fig. 43; Sundström, 1986, p. 72, Figs. 32, 33, and 177–189.

Narrow cells always with four columns of bands. Process tip appearing cleft in LM. Valve and valvocopula deeply conical and apex long and narrow, usually heavily silicified. No otaria.

***Rhizosolenia simplex*** Karsten (Plate 29, Table 34)

References: Karsten, 1905, p. 95, Plate 10, Fig. 1; Sournia et al., 1979, p. 191, Figs. 16 and 24; Sundström, 1986, p. 78, Figs. 35 and 195–199.

Bands indistinct. Process conical, narrowing abruptly and terminating in a short narrow tube. Valve and process a continuous cone. No otaria.

**Distribution:**

*R. temperi*—Mediterranean.

*R. acuminata*, *R. bergonii*, *R. clevei*, *R. hyalina*, *R. castracanei*, and *R. debyana*—warm water region.

*R. simplex* and *R. crassa*—southern cold water region.

B. Section *Imbricatae*. Two lateral columns of segments.

***Rhizosolenia imbricata*** Brightwell (Plate 29, Table 35)

Synonyms: *Rhizosolenia shrubsolei* Cleve; *R. imbricata* var. *shrubsolei* (Cleve) Schröder.

References: Brightwell, 1858a, p. 94, Plate 5, Fig. 6; Cleve, 1881, p. 26; Schröder, 1906, p. 346; Sundström, 1986, p. 80, Figs. 200–208.

Cross section slightly elliptical. Valve obliquely conical. Process swollen basally, narrowing abruptly into a distal tube. Otaria small, extending along the swollen part of the process (not shown on Plate 29).

***Rhizosolenia ostensfeldii*** Sundström (Plate 29, Table 35)

Reference: Sundström, 1986, p. 87, Figs. 37 and 218–226.

---

PLATE 29 *Rhizosolenia imbricata*: two cells in lateral view. After Brightwell (1858a). Scale bar = 20  $\mu\text{m}$ . *Rhizosolenia bergonii*: stout process. After Sundström (1986). Scale bar = 20  $\mu\text{m}$ . *Rhizosolenia simplex*: whole frustule. After Sundström (1986). Scale bar = 50  $\mu\text{m}$ . *Rhizosolenia temperi*: ventral view. Many columns of segments. After Sundström (1986). Scale bar = 50  $\mu\text{m}$ . *Rhizosolenia acuminata*: (a) ventral and (b) dorsal view; (c) detail of labiate structure. After Sundström (1986). Scale bar = 50  $\mu\text{m}$ . *Rhizosolenia ostensfeldii*: ventral view. After Sundström (1986). Scale bar = 50  $\mu\text{m}$ . *Rhizosolenia striata*: (a) lateral and (b) ventral view. After Sundström (1986). Scale bar = 20  $\mu\text{m}$ . *Rhizosolenia fallax*: ventral view. After Sundström (1986). Scale bar = 20  $\mu\text{m}$ . *Rhizosolenia decipiens*: ventral view. After Sundström (1986). Scale bar = 20  $\mu\text{m}$ .



TABLE 35 Morphometric Data of *Rhizosolenia* spp. with Two Lateral Columns of Segments

Species	Diameter or apical axis ( $\mu\text{m}$ )	Length of processes ( $\mu\text{m}$ )	Band areolae in 10 $\mu\text{m}$
<i>R. imbricata</i>	2.5–57	8–18	10–18
<i>R. ostenfeldii</i>	32–56	11–15	21–25
<i>R. fallax</i>	3–23	8–12	17–25
<i>R. striata</i>	11–110	10–18	6–12
<i>R. decipiens</i>	3.5–20	9–14	22–30

Cross-section circular. Valve shallow. Process swollen basally; distal part tubular. Otaria extending along the basal part of the process; distal margin straight to weakly concave.

***Rhizosolenia fallax* Sundström (Plate 29, Table 35)**

**Reference:** Sundström, 1986, p. 89, Figs. 38 and 227–233.

Cross-section circular to slightly elliptical. Valve obliquely conical. Process swollen basally, narrowing abruptly into the distal tube. Otaria small, extending along the swollen part of the process.

***Rhizosolenia striata* Greville (Plate 29, Table 35)**

**References:** Greville, 1864, p. 234, Plate 3, Fig. 4; Sundström, 1986, p. 84, Figs. 36 and 209–217.

Cross-section elliptical. Valve shallow. Process triangular in outline with lateral edges usually weakly concave. Otaria small, extending along the lower part of the process.

***Rhizosolenia decipiens* Sundström (Plate 29, Table 35)**

**Reference:** Sundström, 1986, p. 92, Figs. 39a, 39b, and 234–240.

Cross-section usually circular. Valve obliquely conical. Basal part of the process conical, gradually narrowing into a distal tube of roughly equal length. Otaria narrow, extending along the conical part of the process.

**Distribution:**

*R. imbricata*—widely distributed although not in polar regions.

*R. fallax*—temperate to tropical waters.

*R. decipiens*, *R. ostenfeldii*, and *R. striata*—warm water region.

**Remarks:** The bands of *R. imbricata* and *R. striata* have a similar striation pattern (Fig. 15) but differ in the shape of the valves and the basal part of the processes. The bands of *R. ostenfeldii* and *R. decipiens* have a similar striation pattern (Fig. 15) but these species also differ in the shape of the

valves and the basal part of the processes. The bands of *R. fallax* have a striation pattern different from that of the other species (Fig. 15), whereas the valve process is similar to those of *R. imbricata* and *R. ostensfeldii*. Although the structure may be too fine for the striae to be counted using LM, the striation pattern is visible with LM in all species of this section. *Rhizosolenia chunii* Karsten was also allocated to the section *Imbricatae* by Priddle et al. (1990, p. 118, Plate 15.3, Fig. 2).

C. *Incertae sedis* (*Rhizosolenia*)

***Rhizosolenia setigera* Brightwell (Plate 30)**

**References:** Brightwell, 1858a, p. 95, Plate 5, Fig. 7; Hustedt, 1930, p. 588, Fig. 336; Cupp, 1943, p. 88, Fig. 49; Drebes, 1974, p. 52, Fig. 40; Sundström, 1986, p. 104, Figs. 286–288; Priddle et al., 1990, p. 120, Plate 15.4, Fig. 5.

Cell wall weakly silicified; structure not resolved with LM. Areolae poroid (SEM). Two dorsiventral columns of bands. Valves conical. External process long, almost straight along the whole length, slightly wider for some distance from the base, and gently tapering toward the tip. No otaria. Labiate structure present (G. Hasle, personal observations).

***Rhizosolenia pungens* Cleve-Euler (Plate 30)**

**References:** Cleve-Euler, 1937, p. 43, Fig. 10; Drebes, 1974, p. 52, Fig. 34a.

Basal part of external process narrow, abruptly swollen for about half its length. Otherwise, same as *R. setigera*.

**Morphometric data:** *Rhizosolenia setigera*—4–25  $\mu\text{m}$  in diameter  
*R. pungens*—8–14  $\mu\text{m}$  in diameter.

**Distribution:**

*R. pungens*—mainly brackish water (Swedish and Danish coastal waters, Kiel Bay, Brazil, Japan).

*R. setigera*—cosmopolitan, probably absent from polar waters.

**Remarks:** *Rhizosolenia setigera* and *R. pungens* would fit fairly well into *Pseudosolenia* except for the different shape of the valves and processes. Some species in *Rhizosolenia sensu stricto* have no otaria (Table 34) like *R. setigera* and *R. pungens*. Unlike *R. setigera* and *R. pungens* they have more than two columns of segments and also often have a large diameter. In addition, *R. setigera* forms resting spores in pairs distinctly different from the vegetative cells—a feature which, together with the poroid areolae of the bands (SEM), Sundström (1986) regarded as decisive for excluding this species from *R. sensu stricto*. The reason for listing *R. pungens* as a separate species and not a form or variety of *R. setigera* is the unique shape of the process.

*Rhizosolenia*

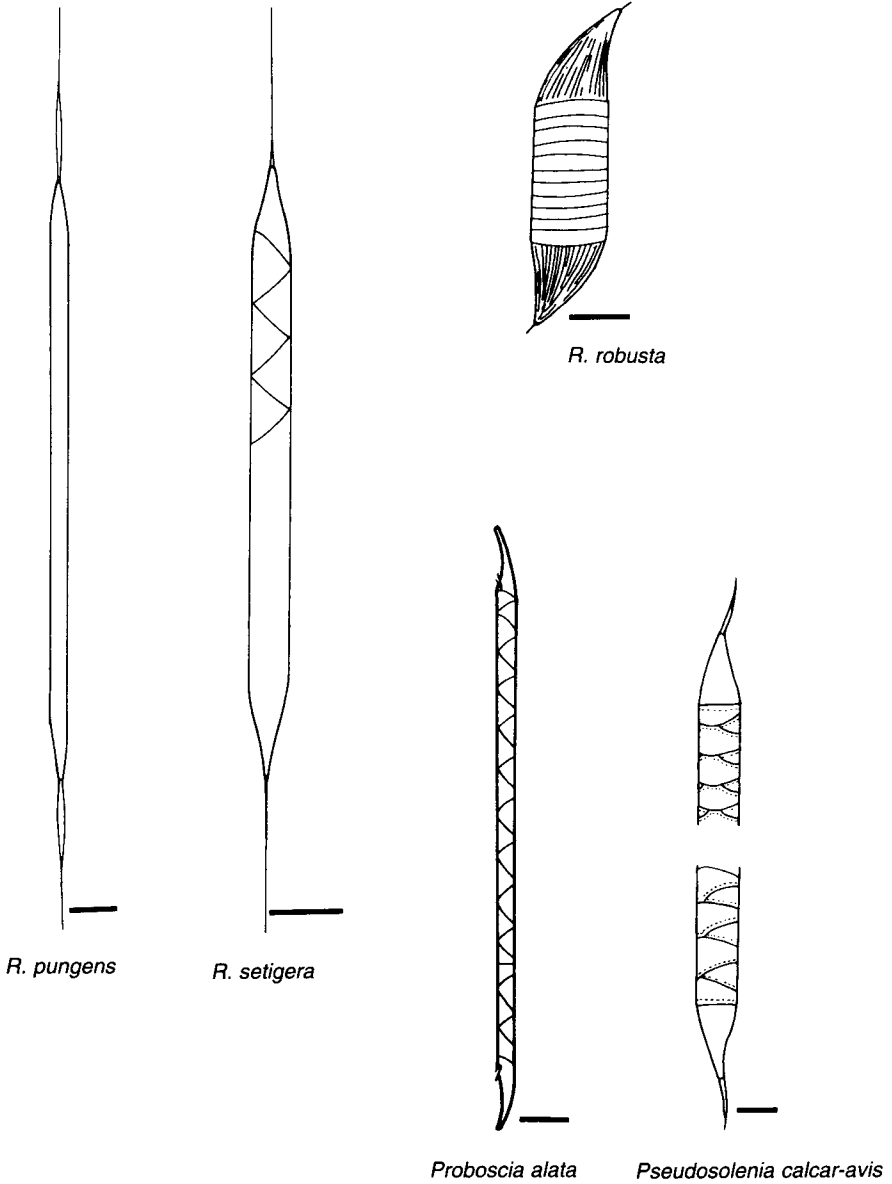

PLATE 30 *Rhizosolenia pungens*: characteristic process, lower part swollen. After Cleve-Euler (1951). Scale bar = 20  $\mu$ m. *Rhizosolenia setigera*: long, tapering process. Scale bar = 20  $\mu$ m. *Rhizosolenia robusta*: frustule with characteristic valves and bands. After Cupp (1943). Scale bar = 100  $\mu$ m. *Proboscia alata*: proboscis. After Brightwell (1858a). Scale bar = 20  $\mu$ m. *Pseudosolenia calcar-avis*: parts of thecae. Scale bar = 20  $\mu$ m.

***Rhizosolenia robusta*** Norman in Pritchard (Plate 30)

**References:** Pritchard, 1961, p. 866, Plate 8, Fig. 42; Hustedt, 1930, p. 578, Fig. 330; Cupp, 1943, p. 83, Fig. 46; Hasle, 1975, p. 110, Figs. 42–47; Sundström, 1986, p. 104, Figs. 289 and 290.

Cells crescent shaped or S shaped. Two columns of typically collar-shaped segments. Areolae loculate (SEM). Valves deeply convex or conical, curved, and with longitudinal lines. External process consisting of a needle-shaped part (?) extending from a short, wider tube (SEM).

**Morphometric data:** Diameter, 48–400  $\mu\text{m}$ ; cell length, 0.5–1 mm; valve areolae, 19–20 in 10  $\mu\text{m}$ ; band areolae, 24–26 in 10  $\mu\text{m}$ .

**Distribution:** Warm water region.

**Remarks:** Sundström's (1986) argument for not including this species in *R. sensu stricto*, despite the presence of areolated segments, was the shape of the valve apex and the tubular process.

**Genus *Proboscia*** Sundström 1986

**Type:** *Proboscia alata* (Brightwell) Sundström.

Valves subconical, terminating in a proboscis. No process. Auxospores terminal. Claspers usually present.

***Proboscia alata*** (Brightwell) Sundström (Plate 30)

**Basionym:** *Rhizosolenia alata* Brightwell.

**References:** Brightwell, 1858a, p. 95, Plate 5, Fig. 8; Drebes, 1974, p. 57, Figs. 39c and 39d; Sundström, 1986, p. 99, Figs. 258–266; Jordan et al., 1991, p. 65, Figs. 1–9.

Bands in two columns, numerous, rhomboidal, with pores (LM) scattered between loculate (SEM) areolae. Proboscis, tip truncate, short longitudinal slit just below tip.

**Morphometric data:** Diameter, 2.5–13  $\mu\text{m}$ .

**Distribution:** “The biogeographical limits cannot be determined without further research” (Sundström, 1986, p. 101).

**Remarks:** Sundström (1986, p. 99) wrote: “*Proboscia* comprises the generic type *P. alata* and an undetermined number of species commonly referred to in the literature as *Rhizosolenia alata*, *Rh. arafurensis*, *Rh. indica*, *Rh. inermis*, *Rh. truncata*, etc.” Jordan et al. (1991) examined Antarctic phytoplankton and made two new combinations, *Proboscia inermis* (Castracane) Jordan & Ligowski and *Proboscia truncata* (Karsten) Nöthig & Ligowski. *Proboscia inermis* has moderately prolonged valves with stout, wedge-shaped, markedly truncate proboscis (Jordan et al., 1991, p. 66, Figs. 10–18). *Proboscia truncata* has either somewhat rounded valves with short, truncate, oblique proboscis, or tapered valves with long, straight or slightly oblique proboscis somewhat wider near its tip (Jordan et al., 1991, p. 70, Figs. 19–29). *Proboscia eumorpha* Takahashi, Jordan & Priddle and *P. subarctica* Takahashi, Jordan & Priddle were described from subarctic waters (Takahashi et al., 1994), and the genus thus includes five modern species.

Genus *Pseudosolenia* Sundström 1986

Type: *Pseudosolenia calcar-avis* (Schultze) Sundström.

Monospecific genus.

*Pseudosolenia calcar avis* (Schultze) Sundström (Plate 30)

Basionym: *Rhizosolenia calcar avis* Schultze.

References: Schultze, 1858, p. 339; Schultze, 1859, p. 19, Figs. 5–8; Hustedt, 1930, p. 592, Fig. 339; Cupp, 1943, p. 89, Fig. 51; Sundström, 1986, p. 95, Figs. 40–46 and 247–257.

Bands in two, or a multiple of two, columns. Areolae poroid (SEM).

Valves subconical. Process claw like. No otaria. Contiguous area roughly sigmoid. Labiate structure different from that in *Rhizosolenia* but similar to the two larger labiate processes in *Coscinodiscus* (SEM).

**Morphometric data:** Diameter, 4.5–190  $\mu\text{m}$ ; process, 28–52  $\mu\text{m}$ ; areolae on bands 28–32 in 10  $\mu\text{m}$  measured with TEM.

**Distribution:** Warm water region, occasionally in temperate waters.

**Remarks:** The shape of the valve and the external as well as the internal parts of process and the poroid areolae distinguish the genus from *Rhizosolenia sensu stricto*.

**How to identify:** Most of the *Rhizosolenia* species as well as *Proboscia* and *Pseudosolenia* may be identified in girdle view in water mounts. In critical cases in which information on the otaria is urgent, valves cleaned of organic matter and mounted in a medium of a high refractive index may be examined in valve view.

Genus *Guinardia* H. Peragallo 1892

Lectotype: *Guinardia flaccida* (Castracane) H. Peragallo (*vide* Round et al., 1990, pp. 326 and 691).

Generic characters:

Low, open ligulate bands usually distinct with LM.

Band structure composed of regular rectangular poroids (EM).

Valve structure composed of faint ribs radiating from the single process (occasionally revealed with LM).

External process tube.

External depression for process of sibling valve.

Characters showing differences between species:

Shape of chains (loose or close set).

Shape of cells (straight or curved).

Shape of valves (flat or convex).

Location of process (central or marginal).

Shape of external part of process.

## KEY TO SPECIES

- 1a. Process maringal . . . . . 2  
 1b. Process central . . . . . *G. cylindrus* (Cleve) Hasle comb. nov.  
 2a. External part of process tubular . . . . . 3  
 2b. External part of process low, inconspicuous. . . . . 4  
 3a. External part of process coarse . . . . .  
 . . . . . *G. striata* (Stolterfoth) Hasle comb. nov.  
 3b. External part of process thin, oblique to pervalvar axis . . . . .  
 . . . . . *G. delicatula* (Cleve) Hasle comb. nov.  
 4a. Marginal process noticeable as a tooth and/or indent . . . . .  
 . . . . . *G. flaccida* (Castracane) H. Peragallo  
 4b. External part of process short, stout (dome shaped). . . . .  
 . . . . . *G. tubiformis* (Hasle) Hasle comb. nov.
- A. Process central: *G. cylindrus* (Table 36).  
 B. Process marginal: *G. delicatula*, *G. flaccida*, *G. striata*, and *G. tubiformis* (Table 36).

## A. Process central.

***Guinardia cylindrus*** (Cleve) Hasle comb. nov. (Plate 31, Table 36)

**Basionym:** *Rhizosolenia cylindrus* Cleve.

**References:** Cleve, 1897a, p. 24, Plate 2, Fig. 12; Hustedt, 1930, p. 572, Fig. 325; Cupp, 1943, p. 80, Fig. 42; Hendey, 1964, p. 148, Plate 3, Fig. 3; Sundström, 1986, p. 103, Figs. 276–278; Priddle et al., 1990, p. 120, Plate 15.4, Figs. 1 and 2.

Solitary or loose chains adjacent cells in touch by the processes. External impression upon adjacent cell discernible with LM. Cells straight. Bands distinct with tapering ends. Valves convex or rounded. External process tube long and curved No observations on its internal part.

## B. Process marginal.

***Guinardia delicatula*** (Cleve) Hasle comb. nov. (Plate 31, Table 36)

**Basionym:** *Rhizosolenia delicatula* Cleve.

**References:** Cleve, 1900b, p. 28, Fig. 11; Hustedt, 1930, p. 577, Fig. 328; Cupp, 1943, p. 83, Fig. 44; Hendey, 1964, p. 147, Plate 4, Fig. 2; Drebes, 1974, p. 49, Fig. 35a; Sundström, 1986, p. 103, Figs. 272 and 273.

Cells in close set straight chains. Bands indistinct. Valves flat and only slightly rounded at the edges. External process thin, pointed, and oblique to the pervalvar axis. Internal part of process probably labiate shaped (*G. Hasle*, personal observations). External depression with **claspers** (EM; Sundström, 1986).

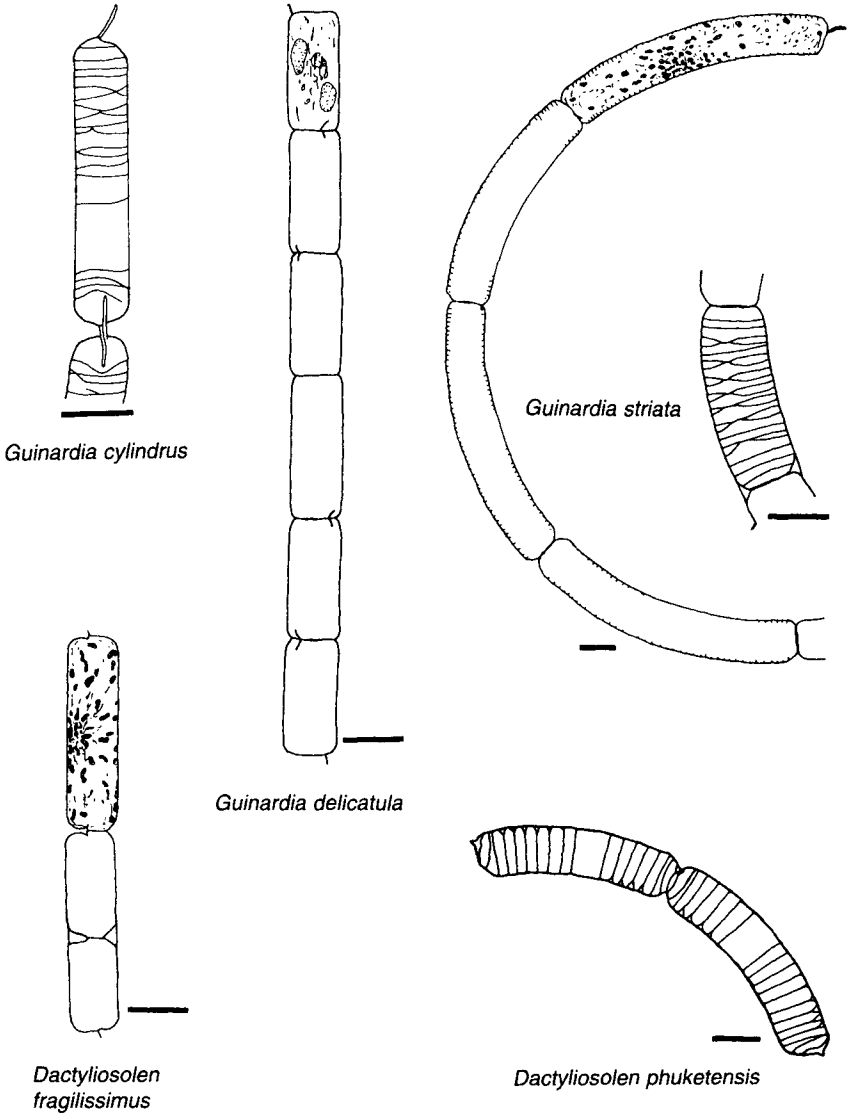

PLATE 31 *Guinardia cylindrus*: Long processes. *Guinardia delicatula*: marginal process evident. After Cupp (1943). *Guinardia striata*: part of helical chain. Details of bands. After Cupp (1943). *Dactyliosolen fragilissimus*: Central process. After Cupp (1943). *Dactyliosolen phuketensis*: stout process and distinct bands. After Sundström (1986). Scale bars = 20  $\mu$ m.

TABLE 36 Morphometric Data of *Guinardia* spp.

Species	Pervalvar axis ( $\mu\text{m}$ )	Diameter ( $\mu\text{m}$ )
Group A		
<i>G. cylindrus</i>	up to 300	8–50
Group B		
<i>G. delicatula</i>	3–5 $\times$ Diameter	9–22
<i>G. flaccida</i>	1.5 to Several $\times$ diameter	25–90
<i>G. striata</i>	up to 250	6–45
<i>G. tubiformis</i>	50–100	3–10

***Guinardia flaccida*** (Castracane) H. Peragallo (Plate 32, Table 36)

**Basionym:** *Rhizosolenia* (?) *flaccida* Castracane.

**References:** Castracane, 1886, p. 74, Plate 29, Fig. 4; Peragallo, 1892, p. 107, Plate 1, Figs. 3–5; Hustedt, 1930, p. 562, Fig. 322; Cupp, 1943, p. 78, Fig. 40; Hendey, 1964, p. 141, Plate 5, Fig. 5; Drebes, 1974, p. 58, Fig. 43a; Hasle, 1975, p. 116, Figs. 64, 65, and 81–89; Takano, 1990, pp. 260–261.

**Girdle view:** Cells in close set chains; cells straight or slightly curved. Bands distinct and collar shaped. Valves flat or slightly concave. Chloroplasts rounded; more or less lobed or cleft plates each with a distinct pyrenoid.

**Valve view:** Valve structure visible with LM; process distinct; external part a curved tube, one end connected with a labiate-shaped internal part and the other end in touch with the external valve surface (EM).

Indentation close to the process probably giving space for process of adjacent cell.

***Guinardia striata*** (Stolterfoth) Hasle com. nov. (Plate 31, Table 36)

**Basionym:** *Eucampia striata* Stolterfoth.

**Synonym:** *Rhizosolenia stolterfothii* H. Peragallo.

**References:** Stolterfoth, 1879, p. 836, Figs. a and b; Peragallo, 1888, p. 82, Plate 6, Fig. 44; Hustedt, 1930, p. 578, Fig. 329; Cupp, 1943, p. 83, Fig. 45; Hendey, 1964, p. 148, Plate 4, Fig. 5; Drebes, 1974, p. 49, Fig. 35b; Hasle, 1975, p. 113, Figs. 66–73; von Stosch, 1986, p. 319, Figs. 13 and 14; Sundström, 1980, p. 580, Figs. 2 and 4; Sundström 1986, p. 103, Figs. 274 and 275.

Cells in close set curved, often spiraling chains. Bands with tapering ends discernible in water mounts. Valves flat and rounded at the edges.

External process fitting into a depression upon the adjacent valve (LM; Hendey, 1964).



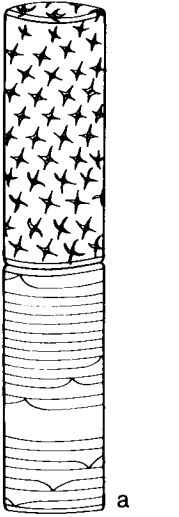

a

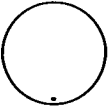

b

*Guinardia flaccida*

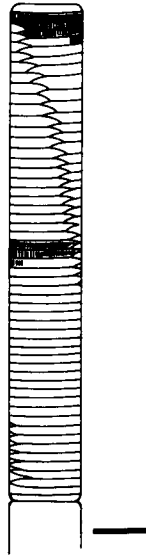

*Dactyliosolen antarcticus*

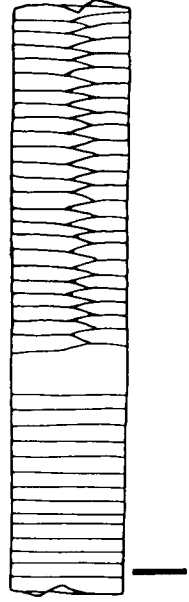

*Dactyliosolen blavyanus*

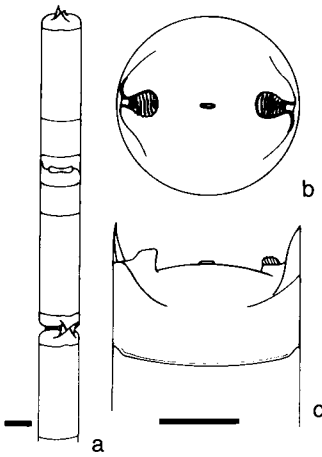

*Cerataulina pelagica*

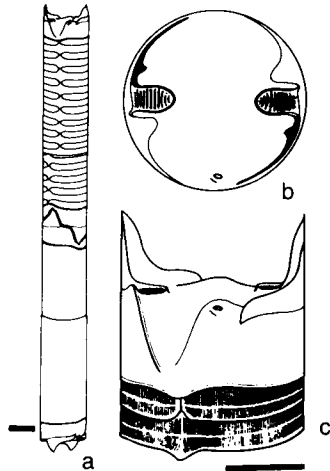

*Cerataulina bicornis*

*Guinardia tubiformis* (Hasle) Hasle comb. nov. (Table 36)

**Basionym:** *Rhizosolenia tubiformis* Hasle.

**References:** Hasle, 1975, p. 115, Text Fig. 1, Fig. 80; Sundström, 1986, p. 104, Figs. 282–285.

Cells in close set straight chains. Bands with tapering ends discernible with LM. Valves flat. Depression corresponding to external part of the adjacent valve probably present (Sundström, 1986).

**Distribution:**

*G. cylindrus*—warm water region.

*G. delicatula*—warm water region (?) to temperate.

*G. flaccida* and *G. striata*—cosmopolitan but not seen in polar waters.

*G. tubiformis*—southern cold water region.

**How to identify:** The species may be identified in girdle view in water mounts or in a medium of higher refractive index or possibly as dried material mounted in air. Cleaned material mounted in a medium of a high refractive index is needed to reveal the valve structure and the internal shape of the process if visible at all with LM.

**Genus *Dactyliosolen*** Castracane 1886

**Type:** *Dactyliosolen antarcticus* Castracane.

**Generic characters:**

Ends of half of the bands wedge shaped.

Valve structure composed of branching ribs radiating from the single process (often too delicate to be revealed with LM).

**Characters showing differences between species:**

Band ends in an oblique or a straight line.

Bands ribbed or with regular rectangular poroid areolae.

Shape of chains (loose or close set).

Shape of cells (straight or curved).

Shape of valves (flat or weakly convex).

---

**PLATE 32** *Guinardia flaccida*: (a) short chain with star-shaped chloroplasts; (b) valve with marginal process. Scale bar = 20  $\mu\text{m}$ . *Dactyliosolen antarcticus*: partial chain in girdle view, band ends in an oblique line. Scale bar = 20  $\mu\text{m}$ . *Dactyliosolen blavyanus*: cell with band ends in a straight line. After Hustedt (1930). Scale bar = 20  $\mu\text{m}$ . *Cerataulina pelagica*: (a) partial chain in girdle view. Scale bar = 20  $\mu\text{m}$ ; (b) valve in valve view; (c) valve in girdle view. Costate ocelli, spines, and central labiate process. Scale bar = 10  $\mu\text{m}$ . From Hasle & Syvertsen (1980). *Cerataulina bicornis*: (a) two cells in girdle view. Scale bar = 20  $\mu\text{m}$ . (b) Valve in valve view with costate ocelli, spines (black), and marginal labiate process; (c) valve with two bands in girdle view. Scale bar = 10  $\mu\text{m}$ . From Hasle & Syvertsen (1980).

- Location of process (marginal or central).  
 Process with or without an external tube.  
 Shape of internal part of process (may be absent).

## KEY TO SPECIES

- 1a. Band ends in a straight line . . . . . 2  
 1b. Band ends in an oblique line . . . . . 4  
 2a. Process marginal . . . . . 3  
 2b. Process central with external tube fitting into a depression (pocket) in adjacent cell . . . . . *D. fragilissimus* (Bergon) Hasle comb. nov.  
 3a. No external process tube. . . . . *D. blavyanus* (H. Peragallo) Hasle  
 3b. Short external process tube fitting into a depression (pocket) in adjacent cell. . . . . *D. phuketensis* (Sundström) Hasle comb. nov.  
 4a. Process central, no external tube . . . . *D. tenuijunctus* (Manguin) Hasle  
 4b. Process marginal, occasionally closer to valve center, no external tube . . . . . *D. antarcticus* Castracane
- A. Band ends in an oblique line: *D. antarcticus*, and *D. tenuijunctus* (Table 37).  
 B. Band ends in a straight line: *D. blavyanus*, *D. fragilissimus*, and *D. phuketensis* (Table 37).

A. Band ends in an oblique line.

*Dactyliosolen antarcticus* Castracane (Plate 32, Table 37)

References: Castracane, 1886, p. 75, Plate 9, Fig. 7; Hustedt, 1930, p. 556, Fig. 316; Cupp, 1943, p. 76, Fig. 37; Hasle, 1975, p. 119, Figs. 90–100, 109–112.

TABLE 37 Morphometric Data of *Dactyliosolen* spp.

Species	Pervalvar axis ( $\mu\text{m}$ )	Diameter ( $\mu\text{m}$ )	Bands in 10 $\mu\text{m}$	Band ribs in 10 $\mu\text{m}$
Group A				
<i>D. antarcticus</i>	Up to 140	13–90	2–3	4–15
<i>D. tenuijunctus</i>	18–55	6–12	5–9	28–36
Group B				
<i>D. blavyanus</i>	—	6–38	4–5	28–32
<i>D. fragilissimus</i>	42–300	8–70	—	—
<i>D. phuketensis</i>	76–236	4.5–54	—	—

Note. —, No data.

**Girdle view:** Close set chains; cells straight; valves flat. Bands coarsely ribbed (LM).

**Valve view:** Valve ribs visible with LM. Internal part of process a low tube with thickened rim (LM).

*Dactyliosolen tenuijunctus* (Manguin) Hasle (Table 37)

**Basionym:** *Rhizosolenia tenuijuncta* Manguin.

**References:** Manguin, 1957, p. 118, Plate 2, Fig. 15; Manguin, 1960, p. 270, Figs. 76 and 77; Hasle, 1975, p. 122, Figs. 114–120; Priddle & Fryxell, 1985, p. 60.

Cells straight, slightly curved, or undulated; valve face flat(?). Bands delicately ribbed. Internal part of process tubular (LM).

B. Band ends in a straight line.

*Dactyliosolen blavyanus* (H. Peragallo) Hasle (Plate 32, Table 37)

**Basionym:** *Guinardia blavyana* H. Peragallo.

**References:** Peragallo, 1892, p. 107, Plate 1, Figs. 1 and 2; Hustedt, 1930, p. 564, Fig. 323; Hasle, 1975, p. 121, Figs. 101–108 and 113; von Stosch, 1986, p. 317, Fig. 12.

**Girdle view:** Close set chains; cells straight; valve surface flat with a marginal indentation at the process. Bands delicately ribbed and discernible with LM.

**Valve view:** Faint valve ribs (LM). Process marginal; internal part tubular (LM).

*Dactyliosolen fragilissimus* (Bergon) Hasle comb. nov. (Plate 31, Table 37)

**Basionym:** *Rhizosolenia fragilissima* Bergon.

**References:** Bergon, 1903, p. 49, Plate 1, Figs. 9 and 10; Hustedt, 1930, p. 571, Fig. 324; Cupp, 1943, p. 80, Fig. 41; Drebes, 1974, p. 48, Figs. 34b and 34c; Hasle, 1975, p. 114, Figs. 61, 62, and 74–78; Sundström, 1986, p. 103, Figs. 268 and 269; Takano, 1990, pp. 262–263.

**Girdle view:** Cells straight and united in loose chains by the central part of valve surface. Bands difficult to see with LM; rectangular poroid areolae (EM). Valves weakly convex. External process tube narrow, slightly curved fitting into a depression (pocket) in adjacent cell, and visible with LM as an indentation near the tube.

**Valve view:** Valve structure too delicate to be resolved with LM. Internal part of process lacking (?).

*Dactyliosolen phuketensis* (Sundström) Hasle comb. nov. (Plate 31, Table 37)

**Basionym:** *Rhizosolenia phuketensis* Sundström.

**References:** Sundström, 1980, p. 579, Figs. 1 and 3; von Stosch, 1986, p. 323, Figs. 15–17; Sundström, 1986, p. 103, Figs. 270 and 271.

Cells curved; in close set curved or spiraling chains. Bands visible with LM; rectangular poroid areolae (TEM). Internal part lacking (?).

**Distribution:**

*D. tenuijunctus*—southern cold water region.

*D. blavyanus*—warm water region to temperate including the Oslofjord, southern Norway in summer.

*D. phuketensis*—warm water region to temperate including North Sea and the Skagerrak (Sundström, 1986).

*D. fragilissimus*—cosmopolitan (?).

*D. antarcticus*—cosmopolitan (?), especially important in the southern cold water region.

**How to identify:** The species may be identified in girdle view in water mounts, in a medium of a higher refractive index, or possibly as dried material mounted in air. Material cleaned of organic matter and mounted in a medium of a high refractive index is needed in order to see the valve structure and the shape of the internal part of the process.

**Remarks:** *Dactyliosolen blavyanus* differs from the other species of the genus by being the only one known to form (endogenous) resting spores and by having the protoplast concentrated to the middle of the cell (von Stosch, 1986). *Guinardia delicatula*, *D. fragilissimus*, *Leptocylindrus danicus*, and *Cerataulina pelagica* often appear together as do *G. striata* and *G. phuketensis*.

They are distinguished by:

Shape of valve.

The presence/absence, shape, and location of process.

Shape of chains, straight/curved, cells closely/ loosely set.

Bands, shape, ends in straight/oblique line.

**Suborder Biddulphiineae**

**Family Hemiaulaceae** Jousé, Kisselev, & Poretsky 1949

The four recent planktonic genera dealt with here were all placed in this family by Simonsen (1979) as well as by Round et al. (1990). In Round et al. (1990), Hemiaulaceae was placed in the new order Hemiaulales Round & Crawford. Glezer et al. (1988) placed *Eucampia* together with *Odontella* and *Biddulphia* in Biddulphiaceae Kützing.

Terminology specific to Hemiaulaceae

**Aperture**—space between valves of adjacent cells in chains.

**Elevation**—raised portion of valve wall, not projecting laterally beyond valve margin, may bear some special structure; otherwise with the same structure as the valve.

**Horn**—long, narrow elevation.

**Ocellus**—plate of silica, pierced by closely packed holes, normally with a thickened structureless rim.

**Costate ocellus**—similar to an ocellus or pseudocellus (see Eupodiscaceae) but with siliceous ribs between rows of pores.

Common morphological characters:

Close set chains formed by apposition of tips of elevations.

Bipolar symmetry.

Bipolar elevations.

Apertures between cells in colonies formed by elevations.

A single labiate process.

Poroid areolae.

Numerous small disc-like chloroplasts.

#### KEY TO GENERA

- 1a. Elevations with spine or wing-like prolongations or with pointed ends . . . . . 2
- 1b. Elevations with obtuse ends . . . . . 3
- 2a. Elevations short, top plates ribbed (costate ocellus) and with spine or wing-like prolongations, apertures between cells in chains narrow . . . . . *Cerataulina*, p. 169
- 2b. Elevations usually long and slender with pointed ends and no ribbed top plate, apertures between cells in chains mostly wide . *Hemiaulus*, p. 176
- 3a. Pervalvar axis usually short, chains sometimes twisted . . . . . *Climacodium*, p. 172
- 3b. Pervalvar axis longer, chains often helically curved, elevations with ribbed top plate (costate ocellus) . . . . . *Eucampia*, p. 172

**Genus *Cerataulina*** H. Peragallo ex Schütt 1896 (Plates 32 and 33, Table 38)

**Type:** *Cerataulina bergonii* (H. Peragallo) Schütt.

TABLE 38 Morphometric Data of *Ceratulina* spp. (Hasle & Syvertsen, 1980)

Species	Pervalvar axis ( $\mu\text{m}$ )	Diameter ( $\mu\text{m}$ )	Valve striae in 10 $\mu\text{m}$
<i>C. bicornis</i>	87–200	5–75	18–30
<i>C. dentata</i>	26–88	5–12	ca. 20
<i>C. pelagica</i>	55–120	7–56	14–25

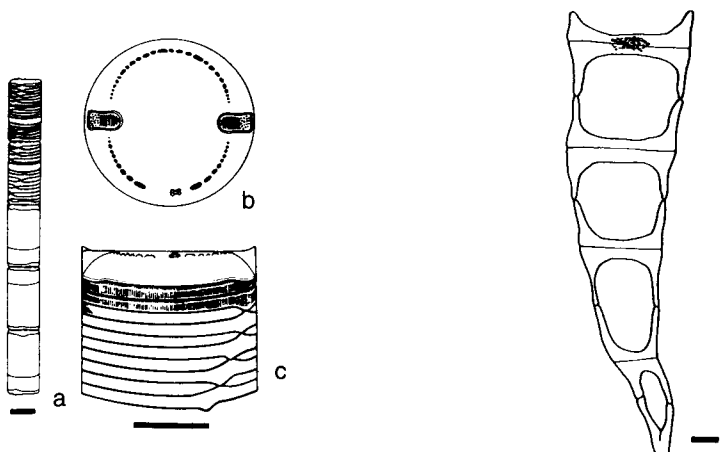

*Cerataulina dentata*

*Climacodium frauenfeldianum*

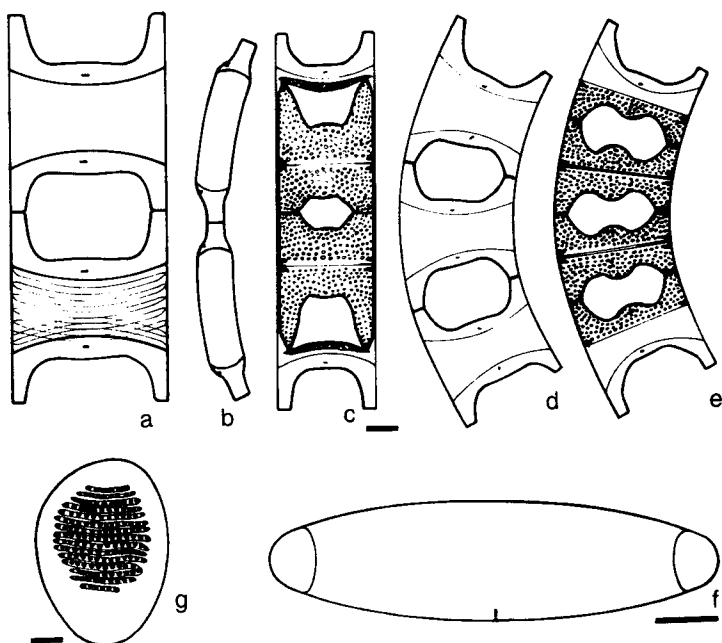

*Eucampia antarctica*

PLATE 33 *Cerataulina dentata*: (a) chain in girdle view. Scale bar = 20  $\mu\text{m}$ ; (b) valve with costate ocelli, marginal labiate process, and dentate margin; (c) valve in girdle view with bands. Scale bar = 10  $\mu\text{m}$ . From Hasle & Syvertsen (1980). *Climacodium frauenfeldianum*: twisted chain. After Cupp (1943). Scale bar = 20  $\mu\text{m}$ . *Eucampia antarctica*: (a and d) chains in broad and (b) narrow girdle view, (c) with semiendogenous resting spores and, (e) with "winter stages." Scale bar = 10  $\mu\text{m}$ ; (f) valve with marginal labiate process. Scale bar = 10  $\mu\text{m}$ ; (g) costate ocellus. Scale bar = 1  $\mu\text{m}$ . From Syvertsen & Hasle (1983).

**Basionym:** *Cerataulus bergonii* H. Peragallo.

**Correct name:** *Cerataulina pelagica* (Cleve) Hendy.

**References:** Ehrenberg, 1845a, p. 365; Greville, 1866, p. 83, Figs. 22–28; Cleve, 1889, p. 54; Peragallo, 1892, p. 103, Plate 13, Figs. 15 and 16; Schütt, 1896, p. 95, Fig. 165; Ostenfeld & Schmidt, 1901, p. 153, Fig. 7; Hustedt, 1930, p. 869, Fig. 517 (vegetative cells of *C. pelagica* and resting spore of *C. bicornis*); Hendey, 1937, p. 279; Cupp, 1943, p. 167, Fig. 117; Hendey, 1964, p. 113, Plate 6, Fig. 4; Hasle & Syvertsen, 1980; Hasle, 1983c; Hasle & Sims, 1985; Takano, 1990, pp. 270–273.

**Generic characters:**

- Cells twisted about perivalvar axis.
- Valves circular to subcircular.
- Elevations low with wing-like extensions.

#### KEY TO SPECIES

- 1a. Bands indistinct or not resolved in water mounts, conspicuous wing-like extensions of elevations. . . . . 2
- 1b. Bands distinct, elevations and wings inconspicuous, valve margin dentate, labiate process submarginal, areola array fan shaped and oriented toward the process. . . . . *C. dentata* Hasle in Hasle & Syvertsen
- 2a. Broad wing-like extensions of the elevations fitting into V-shaped deep furrows on mantle of adjacent valve, labiate process marginal, areola array irregular . . . . .  
. . . . . *C. bicornis*<sup>11</sup> (Ehrenberg) Hasle in Hasle & Sims
- 2b. Wing-like extensions of elevations less conspicuous, labiate process central or subcentral, regular areolae rows oriented toward the process. . . . .  
. . . . . *C. pelagica* (Cleve) Hendey

**Distribution:**

- C. bicornis* and *C. dentata*—coastal warm water region.
- C. pelagica*—cosmopolitan.

**How to identify:** The species may be identified in girdle view in water mounts. In critical cases examination of valve structure made on cleaned material mounted in a medium of a high refractive index may be necessary.

**Remarks:** *Cerataulina bicornis* is the only species of the genus that has been found with resting spores. These are morphologically distinctly different from the vegetative cells and were described as *Syringidium bicornis* (Ehrenberg, 1845a; Hasle & Sims, 1985).

<sup>11</sup> Basionym: *Syringidium bicorne* Ehrenberg. Synonyms: *Cerataulina compacta* Ostenfeld in Ostenfeld & Schmidt; *Cerataulina daemon* (Greville) Hasle in Hasle & Syvertsen.



TABLE 39 Morphometric Data of *Climacodium* spp. (Hustedt, 1930)

Species	Pervalvar axis (µm)	Apical axis (µm)
<i>C. biconcavum</i>	ca. 60	35–65
<i>C. frauenfeldianum</i>	10–30	75–225

**Genus *Climacodium* Grunow 1868 (Plate 33, Table 39)**

**Type:** *Climacodium frauenfeldianum* Grunow.

**References:** Grunow, 1868, p. 102, Plate 1a, Fig. 24; Cleve, 1897a, p. 22, Plate 2, Figs. 16 and 17; Hustedt, 1930, p. 776, Figs. 453 and 454; Cupp, 1943, p. 147, Fig. 105.

**Generic characters:**

- Cells straight but usually forming somewhat twisted chains.
- Valves elliptical.
- Apertures between cells in chains large.

**KEY TO SPECIES**

- 1a. Valve surface between elevations flat, apertures right angled to oblong and larger in pervalvar direction than in the cell proper . . . . . *C. frauenfeldianum* Grunow
- 1b. Valve surface between elevations concave, apertures elliptical lanceolate, usually smaller than the cell proper . . . . . *C. biconcavum* Cleve

**Distribution:** Warm water region.

**How to identify:** The species may be identified as colonies or whole cells in water mounts.

**Genus *Eucampia* Ehrenberg 1839 (Plates 33, 34, and 35, Table 40)**

**Type:** *Eucampia zodiacus* Ehrenberg.

**References:** Ehrenberg, 1841a, p. 151, Plate 4, Fig. 8; Cleve, 1873a, p. 7, Plate 1, Fig. 6; Van Heurck, 1880–1885, Plate 95 bis, Fig. 5; Cleve, 1896a, p. 10,

---

PLATE 34 *Eucampia cornuta*: (a and b) two chains of unequal width in girdle view. Scale bar = 10 µm; (c) valve in girdle view; (d) valve in valve views (central labiate process). Scale bar = 10 µm; (e) costate ocellus. Scale bar = 1 µm. *Eucampia groenlandica*: (a–c) chains in broad and (d) narrow girdle views. Scale bar = 10 µm; (e) valve with central labiate process. Scale bar = 10 µm; (f) costate ocellus. Scale bar = 1 µm. From Syvertsen & Hasle (1983).

*Eucampia*

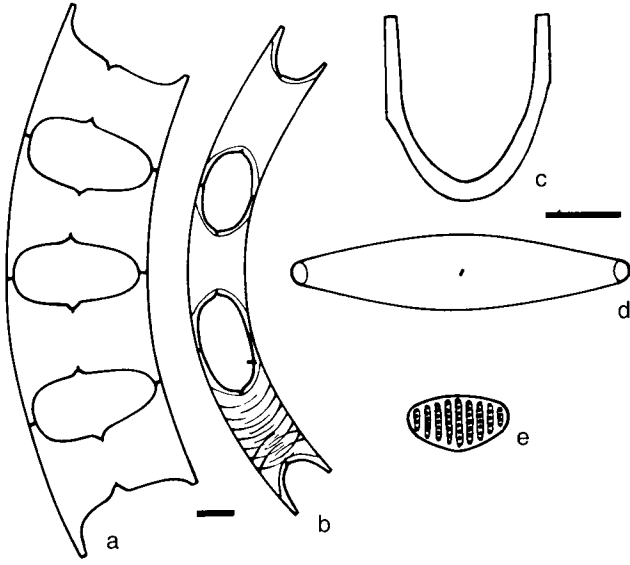

*E. cornuta*

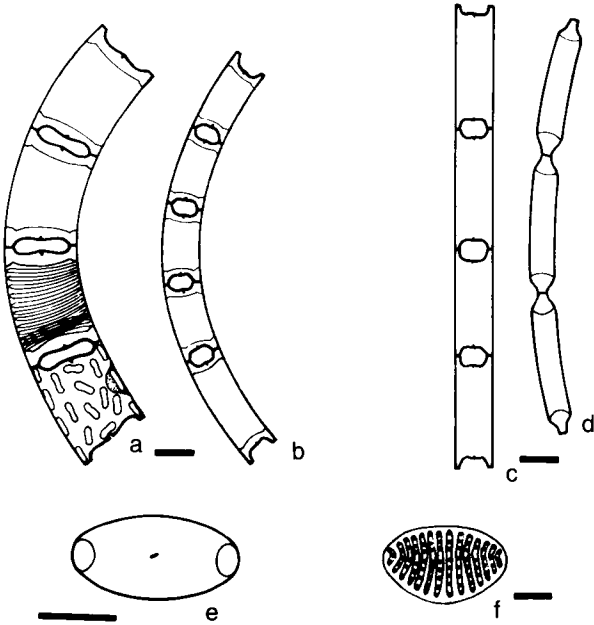

*E. groenlandica*

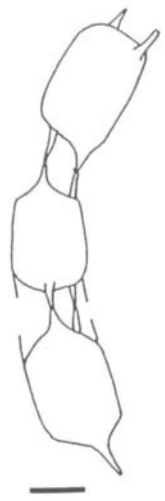
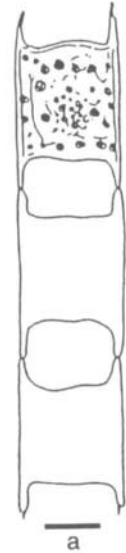
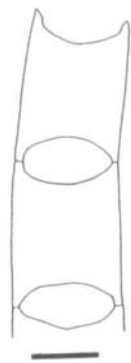
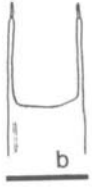
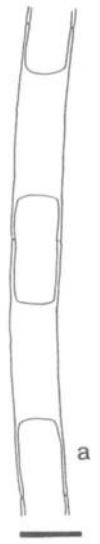
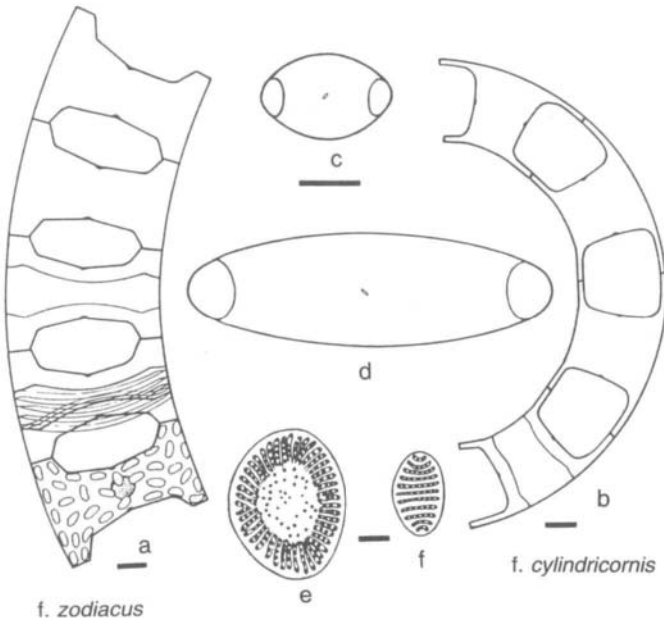

*Hemialus hauckii*

*Hemialus membranaceus*

*Hemialus sinensis*

*Hemialus indicus*

TABLE 40 Morphometric Data of *Eucampia* spp. (Syvertsen & Hasle, 1983)

Species	Apical axis ( $\mu\text{m}$ )	Valve areolae in 10 $\mu\text{m}$
<i>E. antarctica</i>	18–92	3–10
<i>E. cornuta</i>	13–60	7–21
<i>E. groenlandica</i>	10–33	38–42 (SEM)
<i>E. zodiacus</i>	8–80	10–20

Plate 2, Fig. 10; Castracane, 1886, pp. 97 and 98, Plate 18, Figs. 5 and 8; Mangin, 1915, p. 480, Figs. 7 and 8; Hustedt, 1930, p. 771, Figs. 451 and 452; Cupp, 1943, p. 145, Figs. 103 and 104; Drebes, 1974, p. 95, Fig. 79; Syvertsen & Hasle, 1983; Fryxell, 1989, p. 4, Figs. 23–26; Fryxell et al., 1989; Fryxell & Prasad, 1990; Takano, 1990, pp. 274–275.

Generic characters:

Valves elliptical.

Apertures fairly wide.

#### KEY TO SPECIES

- 1a. Valve face concave in broad girdle view . . . . . 2  
 1b. Valve face convex or flat in broad girdle view . . . . . 3  
 2a. Bands distinct in water mounts (ribbed), cells slightly curved in broad girdle view, elevations (horns) long, narrow, apertures tall, elliptical, labiate process in a depression of valve center. . . . .  
 . . . . . *E. cornuta* (Cleve) Grunow  
 2b. Bands not ribbed, scarcely visible, cells curved in broad girdle view, chains helically coiled, horns low,<sup>12</sup> broad, apertures angular elliptical to square, labiate process central. . . . . *E. zodiacus* Ehrenberg

<sup>12</sup> The nominate form. Basionym of *Eucampia cornuta*: *Mölleria cornuta* Cleve, 1873. Synonym of *Eucampia antarctica*: *Eucampia balaustium* Castracane (see Fryxell et al., 1989).

PLATE 35 *Eucampia zodiacus*: (a and b) chains in broad girdle view. Scale bar = 10  $\mu\text{m}$ ; (c and d) valves of different sizes with central labiate process and costate ocelli. Scale bar = 10  $\mu\text{m}$ ; (e and f) costate ocelli of f. *zodiacus* and f. *cylindricornis*, respectively. Scale bar = 1  $\mu\text{m}$ . From Syvertsen & Hasle (1983). *Hemiaulus hauckii*: (a) chain in girdle view; (b) detail. After Cupp (1943). Scale bar = 20  $\mu\text{m}$ . *Hemiaulus membranaceus*. Chain in girdle view. After Cupp (1943). Scale bar = 20  $\mu\text{m}$ . *Hemiaulus sinensis*: chain, (a) in broad girdle view and (b) detail of broad girdle view. After Cupp (1943). Scale bars = 20  $\mu\text{m}$ . *Hemiaulus indicus*: chain after Allen & Cupp (1935). Scale bar = 20  $\mu\text{m}$ .

- 3a. Cells fairly coarsely silicified, cells curved or straight, horns fairly broad, apertures square to hexagonal, labiate process submarginal. . . . .  
 . . . . . *E. antarctica* (Castracane) Mangin
- 3b. Cells lightly silicified, cells curved or straight, helical chains rare, horns usually low, apertures almost square or low elliptical, labiate process large, central . . . . . *E. groenlandica* Cleve

**Distribution:**

*E. antarctica*—southern cold water region.

*E. cornuta*—warm water region.

*E. groenlandica*—northern cold water region

*E. zodiacus*—cosmopolitan, probably absent from polar waters.

**How to identify:** The species may be identified in girdle view in water mounts. Location of labiate process is more easily seen in material embedded in a medium of a high refractive index.

**Remarks:** Syvertsen & Hasle (1983) distinguished between two forms of *E. zodiacus*, *E. zodiacus* f. *cylindricornis* Syvertsen and the nominate form mainly based on the shape and length of the elevations. Fryxell & Prasad (1990) distinguished between two varieties of *E. antarctica*, *E. antarctica* var. *recta* (Mangin) Fryxell & Prasad and the nominate variety mainly based on the shape of cells in broad girdle view. *Eucampia antarctica* var. *recta* has a more polar distribution, and both taxa have heavily silicified “winter stages,” often termed resting spores.

**Genus *Hemiaulus* Heiberg 1863 (Plate 35, Table 41)**

**Type:** *Hemiaulus proteus* Heiberg.

**References:** Greville, 1865a, p. 5, Plate 5, Fig. 9; Cleve, 1873a, p. 6, Plate 1, Fig. 5; Van Heurck, 1880–1885, Plate 103, Fig. 10; Karsten, 1907, p. 394, Plate 46, Figs. 4 and 4a; Hustedt, 1930, p. 874, Figs. 518 and 519; Cupp,

**TABLE 41 Morphometric Data of *Hemiaulus* spp.**

Species	Apical axis ( $\mu\text{m}$ )	Areolae in 10 $\mu\text{m}$
<i>H. hauckii</i>	12–35	16–17
<i>H. indicus</i>	34–40	—
<i>H. membranaceus</i>	30–97	ca. 30 (TEM)
<i>H. sinensis</i>	15–36	7–9 (Valve center) 11–13 (Valve mantle)

Note. —, No data.

1943, p. 168, Figs. 118–120; Sournia, 1968, p. 32, Fig. 29; Ross et al., 1977, p. 187, Figs. 20–41.

The genus has four recent marine plankton species and numerous fossil species.

**Generic characters:**

Cells straight in broad girdle view.

Chains sometimes curved or turned about the long axis.

Valves elliptical.

Elevations mainly long and ends claw like, flattened, or pointed.

**KEY TO RECENT SPECIES**

- 1a. Chains straight, curved or twisted, horns with claw like or narrow, flattened tips. . . . . 2
- 1b. Chains twisted, horns short, with a more or less sharp point, cell wall lightly silicified, areolation and labiate process indistinct. . . . .  
. . . . . *H. membranaceus* Cleve
- 2a. Chains often twisted, horns ending in claw like spines, areolation and labiate process indistinct . . . . . 3
- 2b. Chains straight or curved, horns with flattened tips, areolae and labiate process distinct . . . . . *H. sinensis* Greville
- 3a. Horns long, valve surface flat or slightly concave, apertures large and rectangular. . . . . *H. hauckii* Grunow in Van Heurck
- 3b. Horns shorter, valve surface convex. . . . . *H. indicus* Karsten

**Distribution:**

*H. hauckii* and *H. sinensis*—warm water region to temperate.

*H. indicus*—Indian Ocean, Sea of Java.

*H. membranaceus*—warm water region.

**How to identify:** The species may be identified as whole cells, especially in chains, in water mounts. The single process and the areolation are more distinct on permanent mounts of rinsed or cleaned specimens.

**Remarks:** EM investigations showed that the single labiate process is offset from center in *H. membranaceus* and *H. sinensis*, and apical in *H. hauckii* (Ross et al., 1977). The areolae of *H. sinensis* have well developed vela which seem to be missing in the other two species. *Hemiaulus indicus* has not been examined with EM.

**Family Cymatosiraceae Hasle, von Stosch, & Syvertsen 1983**

Round et al. (1990) established the order Cymatosirales Round & Crawford and a subclass Cymatosiropycidae Round & Crawford for this family,

whereas Glezer et al. (1988) followed the authors of the family and retained it in Biddulphiales. Most of the species of this family are inhabitants of sand and mud flats. *Brockmanniella*, *Cymatosira*, and *Plagiogrammopsis* occur occasionally in plankton, and two genera, *Arcocellulus* and *Minutocellus*, belong to marine plankton and have been recorded as predominant in inshore nano-plankton (Hasle et al., 1983, p. 82).

Terminology partially specific to Cymatosiraceae:

**Fascia** (Fig. 18)—an extension of the central area forming a hyaline (unperforated) band extending the valve, i.e., transapically.

**Linking spines**—marginal spines that link sibling valves in chains.

**Pilus**—long hair flattened proximally.

**Pilus valve**—valve with two pili (the other valve of a cell has a process = heterovalvy).

**Pseudoseptum**—a membranous costa on the inner side of the valve (here in perivalvar direction).

**Tubular process** (Fig. 8)—a simple tube penetrating the valve wall; distinguished from a labiate process with EM.

**Ocellulus**—basically structured the same as an ocellus (see Hemiaulaceae), but with few porelli and a raised rim (EM).

The genera dealt with here are characterized by:

Cells single, in tight chains by linking spines, or in loose ribbons.

Low elevations, each with an ocellulus.

Bipolar symmetry.

One process per cell.

Heterovalvy.

One chloroplast.

#### KEY TO GENERA

- 1a. Pili present . . . . . 2
- 1b. Pili absent . . . . . 4
- 2a. Cells curved in broad girdle view . . . . . 3
- 2b. Cells straight in broad girdle view . . . . . *Plagiogrammopsis*, p. 183
- 3a. Pilus valves concave . . . . . *Arcocellulus*, p. 179
- 3b. Pilus valves convex or convex in the middle and concave closer to the elevations . . . . . *Minutocellus*, p. 182
- 4a. Fascia present, linking spines absent. . . . . *Brockmanniella*, p. 179
- 4b. Fascia absent, linking spines present. . . . . *Cymatosira*, p. 181

**Genus *Arcocellulus*** Hasle, von Stosch, & Syvertsen 1983 (Plate 36, Table 42)

**Type:** *Arcocellulus mammifer* Hasle, von Stosch, & Syvertsen.

**References:** Hasle et al., 1983, p. 54, Text Figs. 10 and 11, Figs. 272–333 and 408–421.

Generic characters:

Solitary or in loose ribbons.

Valve outline narrowly lanceolate, elliptical to subcircular, smaller valves oblong to subcircular, often without pili.

No marginal linking spines.

Marginal ridge inconspicuous.

Cell wall weakly silicified; structure not resolved with LM.

Tubular process.

#### KEY TO SPECIES

- 1a. Cells in girdle view curved in the middle and nearly straight close to apices ( genuflexed ), the two pili of a valve crossing . . . . .  
 . . . . . *A. mammifer* Hasle, von Stosch, & Syvertsen
- 1b. Cells in girdle view evenly curved, the two pili of a valve not crossing . .  
 . . . . . *A. cornucervis* Hasle, von Stosch, & Syvertsen

#### Distribution:

*A. cornucervis*—many records from polar and temperate waters of the northern hemisphere; two records from the South Island, New Zealand.

*A. mammifer*—temperate waters of the North Sea, subtropical habitats along the Texas coast of the Gulf of Mexico.

**Genus *Brockmanniella*** Hasle, von Stosch, & Syvertsen 1983

**Type:** *Brockmanniella brockmannii* (Hustedt) Hasle, von Stosch, & Syvertsen.

Monospecific genus.

***Brockmanniella brockmannii*** (Hustedt) Hasle, von Stosch, & Syvertsen (Plate 36)

**Basionym:** *Plagiogramma brockmannii* Hustedt.

**References:** Hustedt, 1939, p. 595, Figs. 11 and 12; Drebes, 1974, p. 101, Fig. 82; Hasle et al., 1983, p. 34, Text Fig. 5, Figs. 132–155; Gardner & Crawford, 1994, Figs. 30–37.

**Girdle view:** Long, loose, partly twisted ribbons. Cells rectangular, bulging in the middle. Sibling valves abutting in the middle and at the elevations.



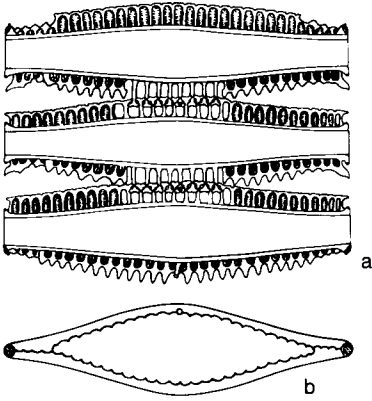

*Cymatosira lorenziana*

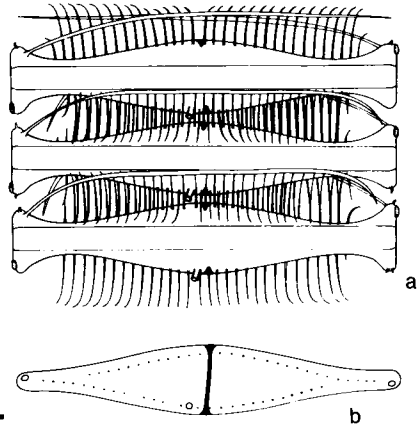

*Plagiogrammopsis vanheurekii*

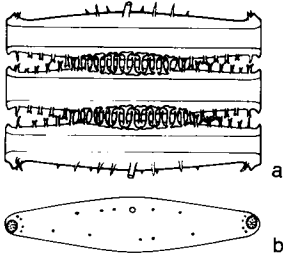

*Cymatosira belgica*

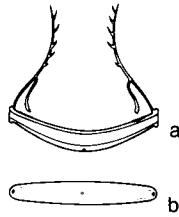

*Arcocellulus cornucervis*

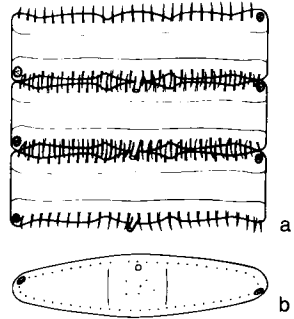

*Brockmanniella brockmannii*

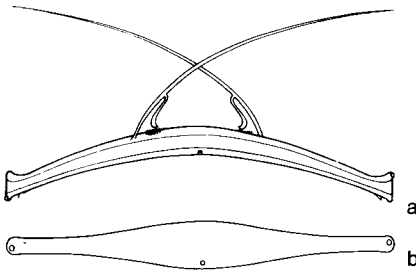

*Minutocellus polymorphus*

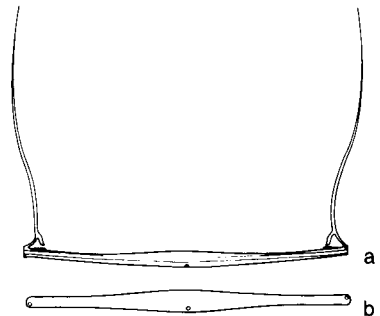

*Minutocellus scriptus*

TABLE 42 Morphometric Data of *Arcocellulus* spp.

Species	Pervalvar axis ( $\mu\text{m}$ )	Apical axis ( $\mu\text{m}$ )	Transapical axis ( $\mu\text{m}$ )
<i>A. cornucervis</i>	1–17	1.2–13	0.7–1.5
<i>A. mammifer</i>	2–4	2–12.5	1.1–1.4

**Valve view:** Valve outline narrowly lanceolate and oblong to subcircular.

Process submarginal in the fascia. Coarse areolation. Labiate process.

**Morphometric data:** Apical axis, 4–36  $\mu\text{m}$ , transapical axis, 3–5  $\mu\text{m}$ ; poroid areolae, 13–15 in 10  $\mu\text{m}$ .

**Distribution:** North European coastal waters in sediment and in spring plankton (in bloom proportions).

#### Genus *Cymatosira* Grunow 1862 (Plate 36, Table 43)

**Type:** *Cymatosira lorenziana* Grunow.

**References:** Grunow, 1862, p. 378, Plate 7, Figs. 25a–25c; Van Heurck, 1880–1885, Plate 45, Figs. 38–42; Hustedt, 1959, p. 127, Figs. 648 and 649; Fryxell & Miller, 1978, p. 122, Figs. 20–31; Hasle et al., 1983, p. 17, Text Figs. 1 and 2, Figs. 1–71.

TABLE 43 Morphometric Data of *Cymatosira* spp.

Species	Pervalvar axis ( $\mu\text{m}$ )	Apical axis ( $\mu\text{m}$ )	Transapical axis ( $\mu\text{m}$ )	Valve areolae in 10 $\mu\text{m}$
<i>C. belgica</i>	ca. 4	10–40	3–5	9–12
<i>C. lorenziana</i>	—	12–60	6–11	8–10

Note. —, No data.

PLATE 36 *Cymatosira lorenziana*: (a) short chain in girdle view with central linking spines and separation valves on end cells; (b) valve with marginal ridge, labiate process, and ocelluli. *Cymatosira belgica*: (a) typical triplet with linking spines and separation valves; (b) separation valve with spines, labiate process, and ocelluli. *Plagiogrammopsis vanheurckii*: (a) short chain with marginal spines and pili; (b) valve with labiate process, pseudoseptum, and ocelluli. *Brockmanniella brockmannii*: (a) chain and (b) valve with fascia, labiate process, and ocelluli. *Arcocellulus cornucervis*: (a) cell in girdle view with branched pili; (b) process valve (tubular process). *Minutocellus polymorphus*: (a) cell in girdle view with pili; (b) process valve (tubular process). *Minutocellus scriptus*: (a) cell in girdle view; (b) Process valve. From Hasle et al. (1983). Scale bar = 10  $\mu\text{m}$ .

## Generic characters:

Partly twisted ribbons.

Marginal spines linking the middle part of the valves.

Cell wall coarsely silicified.

Labiate process.

## KEY TO SPECIES

- 1a. Cells rectangular in girdle view, both valves slightly convex in the middle, valve outline broadly lanceolate with produced ends, nonareolated valve area absent. . . . . *C. lorenziana* Grunow
- 1b. Larger cells curved in girdle view, one valve convex in the middle, the other slightly concave or almost straight, valve outline lanceolate to linear oblong, nonareolated area present in the middle of the valve . . . . .  
. . . . . *C. belgica* Grunow

## Distribution:

*C. belgica*—cosmopolitan, mostly on sandy beaches.*C. lorenziana*—warm water region to temperate, coastal.

Genus *Minutocellus* Hasle, von Stosch, & Syvertsen 1983 (Plate 36, Table 44)

Type: *Minutocellus polymorphus* (Hargraves & Guillard) Hasle, von Stosch, & Syvertsen.

Basionym: *Bellerochea polymorpha* Hargraves & Guillard.

References: Hargraves & Guillard, 1974, p. 167, Figs. 1–8; Hasle et al., 1983, p. 38, Text Figs. 6 and 8, Figs. 156–189 and 220–242; Takano, 1990, pp. 278–279.

## Generic characters:

Solitary or in ribbons.

Cell outline narrowly lanceolate, elliptical to subcircular.

Cell wall weakly silicified, structure not resolved with LM.

Tubular process.

TABLE 44 Morphometric Data of *Minutocellus* spp.

Species	Pervalvar axis ( $\mu\text{m}$ )	Apical axis ( $\mu\text{m}$ )	Transapical axis ( $\mu\text{m}$ )
<i>M. polymorphus</i>	2	2–30	2–3
<i>M. scriptus</i>	0.6–3	3–36	2–2.5

## KEY TO SPECIES

- 1a. Both valves of cells in girdle view evenly curved, pili usually arising at some distance from the elevations on the convex valve, crossing each other in girdle view, smaller cells in ribbons . . . . .  
*M. polymorphus* (Hargraves & Guillard) Hasle, von Stosch, & Syvertsen
- 1b. Pilus valve convex in the middle and concave distally, the other valve slightly convex, pili arising close to the elevations, more or less parallel in girdle view, diverging from the apical axis when seen in valve view, solitary . . . . .  
*M. scriptus* Hasle, von Stosch, & Syvertsen

**Distribution:**

*M. polymorphus*—probably cosmopolitan, marine, planktonic.

*M. scriptus*—known only from Helgoland and Bremerhaven, Germany, probably planktonic.

**Genus** *Plagiogrammopsis* Hasle, von Stosch, & Syvertsen, 1983

**Type:** *Plagiogrammopsis vanheurckii* (Grunow) Hasle, von Stosch, & Syvertsen.

Monospecific genus.

*Plagiogrammopsis vanheurckii* (Grunow) Hasle, von Stosch, & Syvertsen (Plate 36)

**Basionym:** *Plagiogramma vanheurckii* Grunow in Van Heurck.

**References:** Van Heurck, 1880–1885, Plate 36, Fig. 4; Hasle et al., 1983, p. 30, Text Fig. 4, Figs. 104–131; Gardner & Crawford, 1994, Figs. 20–29.

**Girdle view:** Ribbons, often twisted around their long axis. Cells in girdle view convex in the middle and constricted near the elevations.

**Valve view:** Valve outline narrowly lanceolate with rostrate apices or broadly lanceolate, rhombic or subcircular. Fascia with a pseudoseptum.

Labiate process submarginal in the fascia. Coarse areolation.

**Morphometric data:** Apical axis 3–50  $\mu\text{m}$ ; transapical axis, 4  $\mu\text{m}$ ; valve areolae, 12 in 10  $\mu\text{m}$ .

**Distribution:** Cosmopolitan.

**How to identify:** *Brockmanniella*, *Cymatosira*, and *Plagiogrammopsis* may be identified in water mounts in girdle as well as in valve view. *Arcocellulus* and *Minutocellus* may easily be overlooked in water mounts, especially the smaller specimens. The larger and medium sized specimens with pili are characteristic and readily observable. The extreme variation in valve outline depending on cell size, present in all genera, also complicates the identification when cleaned material mounted in a medium of a high refractive index or in EM is examined.

**Remarks:** The labiate process of *Brockmanniella*, *Cymatosira* and *Plagiogrammopsis* has a tubular external part (EM) and is discernible with

LM. The tubular process of *Arcocellulus* and *Minutocellus* is short externally and internally and is visible with EM.

*Incertae sedis* (Cymatosiraceae):

**Genus** *Lennoxia* Thomsen & Buck 1993

**Type:** *Lennoxia faveolata* Thomsen & Buck.

Monotypic genus.

*Lennoxia faveolata* Thomsen & Buck

**Reference:** Thomsen et al., 1993, p. 279, Figs. 1–16.

**Girdle view:** Cells bipolar and rostrate. Approximately eight weakly silicified bands without ornamentation. One chloroplast.

**Valve view:** Spindle shaped, apical axis curved; middle part roughly triangular. Valve face with honeycomb pattern of flat, hexagonal chambers (TEM). Reminiscent marginal tubular process on one valve (TEM).

**Morphometric data:** Apical axis, 10–22  $\mu\text{m}$ ; pervalvar axis, 1.5–2  $\mu\text{m}$ ; hexagonal chambers, 0.15–0.2  $\mu\text{m}$  in diameter.

**Distribution:** South America, central California, West Greenland, and Denmark. Cell counts published by Thomsen et al. (1993) characterize the species as an important, frequently and abundantly occurring species in marine plankton.

**How to identify:** When examined with LM *L. faveolata* is confusingly similar to certain species of the subgenus *Nitzschiella*, and if ever observed, it has most probably been identified as *Nitzschia closterium*/*Cylindrotheca closterium*.

**Family Chaetocerotaceae** Ralfs in Prichard 1861

*Bacteriastrum* and *Chaetoceros* belong in this family (Simonsen, 1979; Glezer et al., 1988; Round et al., 1990). For the sake of convenience *Attheya* is also mentioned here since two former *Chaetoceros* species, *C. armatus* and *C. septentrionalis*, are now transferred to *Attheya* (Crawford et al., 1994). *Attheya* is usually not classified under Chaetocerotaceae, and it is not primarily planktonic. Simonsen (1979) placed *Attheya* in Hemiauloideae, subfamily of Biddulphiaceae. The family Hemiaulaceae is, in this chapter, used for diatoms with valve outgrowths, called elevations or horns, structured like the rest of the valve and not projecting laterally beyond the valve margin. The valve outgrowths of Hemiaulaceae thus differ from the setae of Chaetocerotaceae in structure and orientation (see below). The valve outgrowths of *Attheya* spp. are structured very much like the rest of the valve, and they do not project outside the valve margin in the generitype *A. decora* but they do in the former *C. armatus* and *C. septentrionalis* (Plate 47; Round et al., 1990, p. 334). Round et al. (1990) solved the problem concerning the classification of *Attheya* by

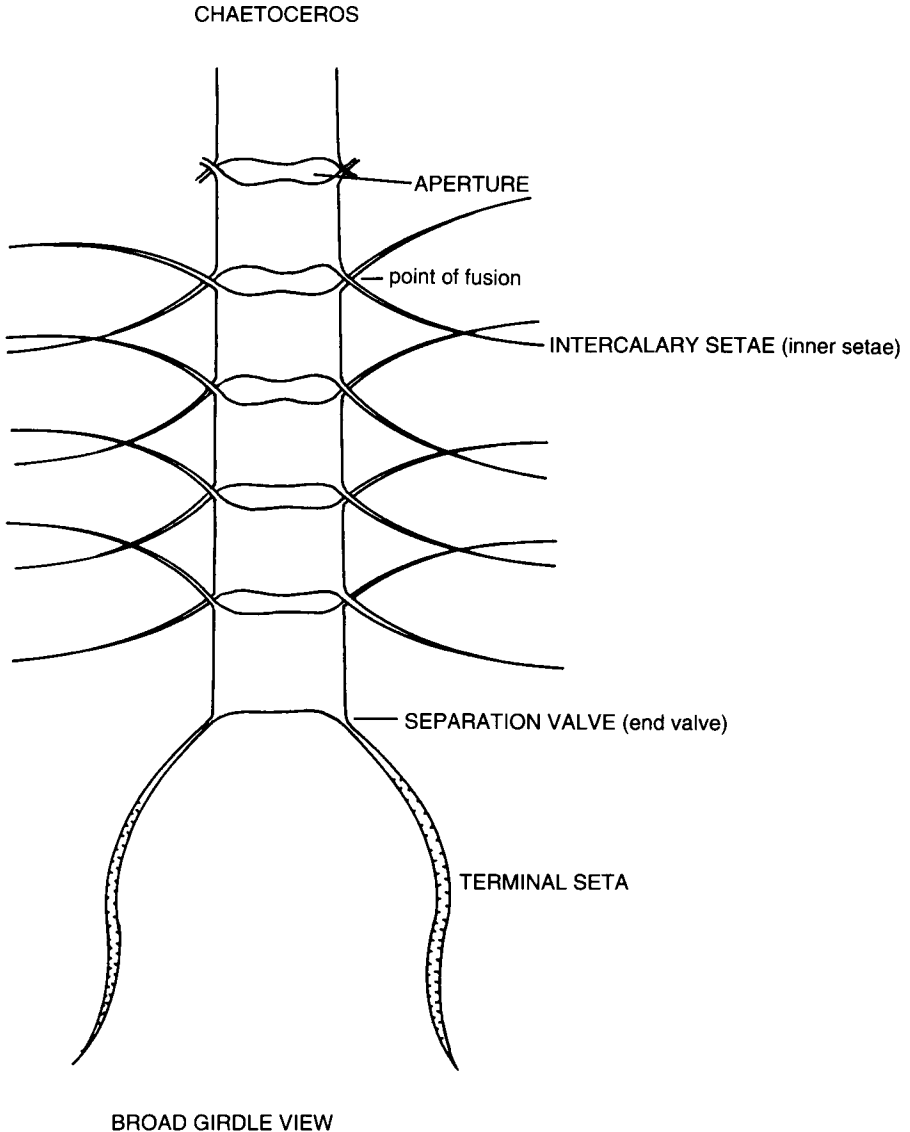

FIGURE 16 Schematic illustration of *Chaetoceros* sp. in broad girdle view with terminology.

describing a new monotypic family Attheyaceae Round & Crawford. The new family and Chaetocerotaceae were placed in the order Chaetocerotales Round & Crawford in the subclass Chaetocerotophycidae Round & Crawford. Terminology specific to Chaetocerotaceae (partially after Rines & Hargraves, 1988) (Fig. 16):

**Aperture—foramen**—open space between adjacent (sibling) cells/valves in chains.

**Seta**—hollow outgrowth of valve projecting outside the valve margin, with structure different from that of the valve.

**Inner setae**—intercalary setae—setae occurring within the chain.

**Terminal setae**—setae of end valves of a chain (= separation valves).

**Basal part**—portion of a terminal seta closest to valve face, portion of an inner seta between its point of origin on valve face and its point of fusion or crossing with its sibling seta.

Family characters:

Valves with long setae.

Cells solitary or, in chains, mostly inseparable, formed by fusion of silica between setae.

Resting spores common, always endogenous and distinctly different from the vegetative cells.

Because of the fusion of silica between setae, sibling valves from cells within a chain are usually held together by their setae when organic material has been removed, as in *Skeletonema costatum*, by the external parts of the strutted processes.

### KEY TO GENERA

- 1a. Generally two setae per valve, one at each end of the apical axis . . . . .  
 . . . . . *Chaetoceros*, p. 189
- 1b. More than two setae per valve, regularly arranged around its margin . .  
 . . . . . *Bacteriastrum*, p. 186

**Genus *Bacteriastrum*** Shadbolt 1854 (Plate 37, Table 45)

**Lectotype:** *Bacteriastrum furcatum* Shadbolt (*vide* Boyer, 1927, p. 114).

**Synonym:** *Bacteriastrum varians* Lauder.

**References:** Shadbolt, 1854, p. 14, Plate 1, Fig. 1; Lauder, 1864a, p. 8, Plate 3, Figs. 1–6; Cleve, 1897a, p. 19, Plate 1, Fig. 19; Ikari, 1927; Pavillard,

---

**PLATE 37** *Bacteriastrum elongatum*: (a) part of chain in girdle view. After Cupp (1943). *Bacteriastrum comosum*: chain in girdle view. After Cupp (1943). *Bacteriastrum hyalinum*: (a) terminal parts of chain, girdle view; (b) terminal valve with central process. After Cupp (1943). *Bacteriastrum delicatulum*: (a) part of chain in girdle view; (b) intercalary valve in valve view. After Cupp (1943). *Bacteriastrum furcatum*: (a) terminal parts of chain in girdle view; (b) terminal, (d) middle valve, and (c and e) intercalary valves in valve view. After Hustedt (1930). Scale bars = 20  $\mu\text{m}$ .

Bacteriastrum

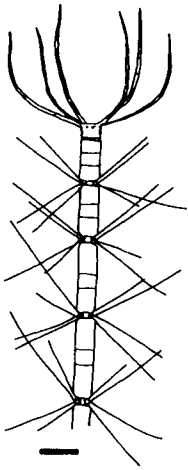

*B. elongatum*

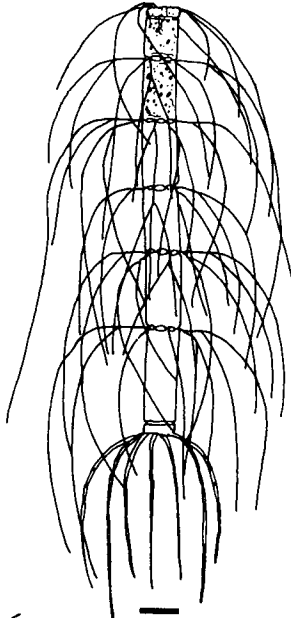

*B. comosum*

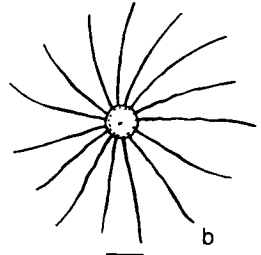
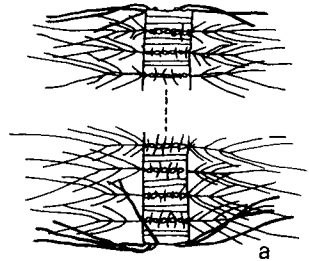

*B. hyalinum*

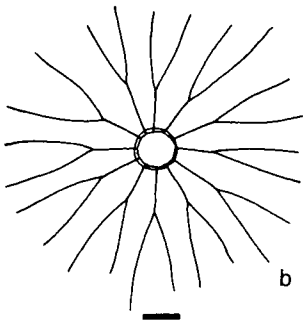
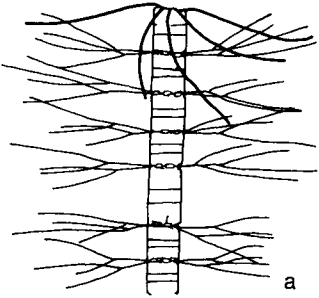

*B. delicatulum*

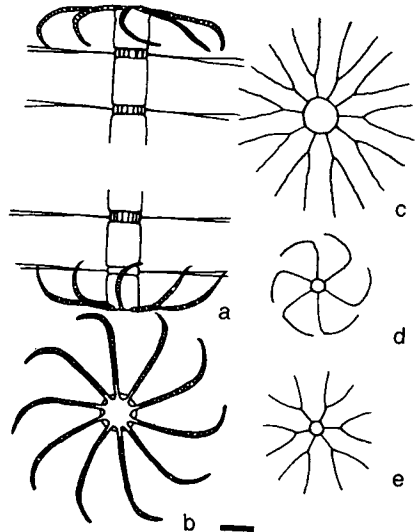

*B. furcatum*

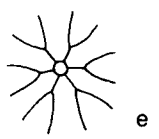
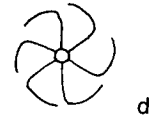
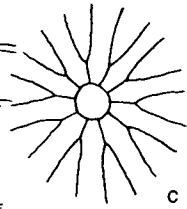



TABLE 45 Morphometric Data of *Bacteriastrum* spp.

Species	Pervalvar axis (µm)	Diameter (µm)	No. of inner setae per valve
<i>B. comosum</i>	—	5–22	6–8
<i>B. delicatulum</i>	20–60	6–20	6–12
<i>B. elongatum</i>	Up to 50	6–27	5–9
<i>B. furcatum</i>	—	—	6–10 ?
<i>B. hyalinum</i>	—	13–56	7–32

Note. —, No data; ?, data uncertain.

1924; Hustedt, 1930, p. 610, Figs. 353–624; Cupp, 1943, p. 95, Figs. 55–58; Drebes, 1972; Drebes, 1974, p. 60, Figs. 45–47; Boalch, 1975; Fryxell, 1978c, p. 63, Figs. 1–17.

*Bacteriastrum* is exclusively marine and planktonic. Five of the most frequently recorded species are dealt with here. Boalch (1975) showed that *B. varians* was a later synonym of *B. furcatum* and that *B. hyalinum* could be considered to be a distinct species. *Bacteriastrum delicatulum* was suggested to be synonymous with *B. furcatum* (Hustedt, 1930) but was retained as a separate species by Cupp (1943).

Generic characters:

Cells cylindrical.

Chloroplasts numerous, small, and roundish and more or less lobed.

Setae of two adjacent cells fused for a certain distance beyond point of origin on valve surface, further out divided, and branched again (bifurcation).

Terminal setae different from the others; not fused, not branched, and often curved.

One central process within an annulus on terminal valves; no such process on intercalary valves, inner opening of process with or without labiate-shaped protrusions or thickenings; outer part a low tube (EM).

Valve structure consisting of fine costae branching out from the annulus in a fan-shaped pattern close to valve margin and small scattered pores (TEM).

Resting spores (endogenous) in *B. hyalinum*.

KEY TO SPECIES

- 1a. Terminal setae of similar construction and form on both ends of chains ..... 2

- 1b. Terminal setae on either end of chain different in form and direction, inner setae very long and curved in the same direction along chain axis. . . . .  
 . . . . . *B. comosum* Pavillard
- 2a. Bifurcation in the apical plane ( parallel to chain axis), fused part of inner setae short . . . . . 3
- 2b. Bifurcation in the valvar plane ( transverse to chain axis), fused part of inner setae long. . . . . 4
- 3a. Terminal setae with arched base, then running outward nearly parallel to chain axis, bell shaped, inner setae usually six on each valve . . . . .  
 . . . . . *B. elongatum* Cleve
- 3b. Terminal setae umbrella shaped, inner setae numerous on each valve . . .  
 . . . . . *B. hyalinum* Lauder
- 4a. Terminal setae of both ends directed toward the chain. . . . .  
 . . . . . *B. delicatulum* Cleve
- 4b. Terminal setae first transverse to chain axis, then abruptly obliquely curved toward the chain in their outer part. . . . . *B. furcatum* Shadbolt

**Distribution:**

*B. comosum*—warm water region.

*B. delicatulum*—temperate waters.

*B. elongatum*—warm water region to temperate.

*B. furcatum*—poorly known, often recorded under the name *B. varians* and confused with *B. hyalinum* (Hustedt, 1930; Cupp, 1943).

*B. hyalinum*—common in temperate waters.

**How to identify:** The species may be identified in water mounts, especially if it is present as intact chains showing the shape of the terminal setae. Some other characters may be used for identification of single cells or part of chains, e.g., for *B. comosum*, the long, inner setae bent toward the one terminal valve with coarse setae; for *B. elongatum*, the long cells; for *B. hyalinum*, the large number of inner setae and the hairy appearance caused by bifurcation of the setae in the apical plane; for *B. delicatulum*, the slightly curved and wavy branches of the inner setae; and for *B. furcatum*, the inner part of the terminal setae perpendicular to the end valve surface.

**Remarks:** *Bacteriastrium furcatum* was found in “near-bloom numbers” in the northwest Gulf of Mexico (Fryxell, 1978c). *Bacteriastrium hyalinum* seems to be the most common species of the genus in the North Sea and the north Atlantic Ocean, especially in summer (Hendey, 1964; Drebes, 1972).

**Genus *Chaetoceros* Ehrenberg 1844**

**Lectotype:** *Chaetoceros tetrachaeta* Ehrenberg (*vide* Boyer, 1927, p. 104).

The genus, *Chaetoceros dictchaeta* and *C. tetrachaeta*, were described in the same paper based on Antarctic material (Ehrenberg, 1844b, pp. 198 and 200, genus and species, respectively). *Chaetoceros tetrachaeta* is regarded as a taxonomic entry not recommended for use (VanLandingham, 1968), whereas *C. dictchaeta* is frequently recorded from the Antarctic.

*Chaetoceros* is one of the largest, if not the largest genus of marine planktonic diatoms with approximately 400 species described. Although it is assumed that only a fraction, “no more than one-third to one-half,” are still valid (Rines & Hargraves, 1988, p. 19), it leaves us with a high number of species, almost all of which are marine.

Several attempts have been made to impose structure on this large genus by a division into two subgenera and numerous sections (see Hustedt, 1930, p. 630; Cupp, 1943, p. 101; Rines & Hargraves, 1988, pp. 21, and 117). For the sake of simplicity only the names of the subgenera, *Phaeoceros* and *Hyalochaete*, will be used here, and species within both subgenera are grouped according to prominent morphological character(s). Hernández-Becerril (1993a) proposed a new sugenus *Bacteriastroidea* for *Chaetoceros bacteriastroides* Karsten and changed the subgenus name *Phaeoceros* to *Chaetoceros*. Hernández-Becerril (1992b; 1993a,b) and Hernandez-Becerril et al. (1993) examined seven warm water *Chaetoceros* species which are not dealt with in this chapter.

#### Generic characters:

Cells more or less rectangular in girdle view.

Cells elliptical to almost or rarely circular in valve view.

Opposite setae of adjacent cells (sibling setae) “touch” one another near their origin.

#### Characters showing differences between species (partially after Rines & Hargraves, 1988):

##### Chloroplasts

The presence/absence in setae.

Number.

Shape.

Size.

##### Setae

Coarseness (thickness, spines).

Direction.

Terminal setae different from the inner setae in shape and coarseness (e.g., *C. affinis*) and in direction (e.g., *C. atlanticus*).

Some inner setae different from the others (e.g., *C. compressus* and *C. diversus*).

Adjacent (sibling) setae fused for some distance (e.g., *C. decipiens*).

One seta of a cell longer than the three others (e.g., *C. socialis*).

Direction of basal part of setae.

Point of fusion of sibling setae: inside valve or chain margin, at the margin, external to the margin.

Shape and size of aperture determined by

Point of origin of setae on valve surface.

Point of fusion of sibling setae (e.g., basal part absent; i.e., apices of sibling valves touching: *C. curvisetus* and *C. constrictus*; basal part present and point of fusion of sibling setae at some distance away from the valves: *C. debilis* and *C. diadema*).

Height of girdle

e.g., in *C. convolutus* > one-third of perivalvar axis; in *C. concavicornis* < one-third of perivalvar axis.

Direction of chain

Straight (e.g., *C. lacinosus*).

Curved or helical (e.g., *C. debilis*).

Twisted (e.g., *C. tortissimus*).

Resting spores

Primary valve (epivalve) and secondary valve (hypovalve) similar or dissimilar.

Spiny or smooth.

Protuberances with branches.

Paired spores with fused setae of parent hypothecae.

For information on resting spores see Proschkina-Lavrenko (1955) who also includes species not mentioned in this chapter.

#### A. Subgenus *Phaeoceros* Gran 1897

Subgeneric characters:

Chloroplasts numerous small granules throughout the whole cell, the setae included.

Large robust forms.

Setae strong, thick, often very long, striated, and armed with conspicuous spines.

One, seldom many, central processes on every valve, often located closer to one side of the valve; no protrusion or thickening around the inner opening (EM).

Valves irregularly perforated with simple holes; more weakly silicified valves with a weak pattern of costae branching out from an annulus (TEM).

Mostly oceanic.

Resting spores reported for one species.

1. Cells solitary or in short chains; external part of central process inconspicuous: *C. aequatorialis*, *C. criophilus*, *C. danicus*, *C. peruvianus*, and *C. rostratus* (Table 46).

2. Terminal setae differentiated from the others by length and direction, straight chains, wide apertures; external part of central process long and tubular: *C. atlanticus* and *C. dictyota* (Table 47).
3. Terminal setae not distinctly differentiated from the others; setae often diverging in all directions; apertures smaller than cell body; external part of processes inconspicuous: *C. borealis*, *C. castracanei*, *C. coarctatus*, *C. concavicornis*, *C. convolutus*, *C. dadayi*, *C. densus*, *C. eibenii*, and *C. tetrastichon* (Table 48).
4. Setae not fused; apertures narrow in apical and perivalvar directions; setae delicate; external part of central process inconspicuous: *C. flexuosus*

#### B. Subgenus *Hyalochaetae* Gran 1897

##### Subgeneric characters:

Chloroplasts, one or a few plates or, more rarely, numerous small granules.

Setae thin, often hair-like; spines and structure seen with LM in some species; no chloroplasts.

One, seldom several, central processes on terminal valves and no such processes on intercalary valves; inner opening of processes with or without labiate-shaped protrusions (EM).

Valves with a more or less regular pattern of costae branching out from an annulus; often holes or poroids between the costae (TEM).

Mainly distributed in coastal and inshore waters.

Resting spores in many species.

1. Cells with more than two chloroplasts.
  - a. Four to 10 chloroplasts; terminal setae more or less differentiated from the others by coarseness and orientation: *C. decipiens*, *C. lorenzianus*, and *C. mitra* (Table 49).
  - b. Numerous small plate-like chloroplasts; terminal setae scarcely different from the others: *C. compressus*, *C. teres*, and *C. lauderi* (Table 49).
2. Cells with two chloroplasts.
  - a. Cells with a hemispherical or conical protuberance: *C. didymus* (Table 50).
  - b. Cells with deep constriction between valve and girdle band: *C. constrictus* (Table 50).
  - c. Apertures high, elliptical, and square to rectangular: *C. lacinosus* (Table 50).
  - d. Adjacent cells touching each other in the middle by a central raised region; apertures narrow and divided into two parts: *C. similis* (Table 50).

- e. Setae of adjacent cells not crossing; connected by a pervalvarly directed bridge: *C. anastomomosans* (Table 50).
- 3. Cells with one chloroplast.
  - a. Chains curved or helical; intercalary setae all bent in one direction: *C. curvisetus*, *C. debilis*, and *C. pseudocurvisetus* (Table 51).
  - b. Chains mostly loose; resting spores united in pairs; resting spore parent cells with fused hypoalvar setae and no apertures: *C. cintus*, *C. furcellatus*, and *C. radicans* (Table 52).
  - c. Inner setae of two kinds: *C. diversus* and *C. messanensis* (Table 53).
  - d. Valves of adjacent cells touch: *C. affinis*, *C. costatus*, *C. karianus*, *C. subtilis*, and *C. wighamii* (Table 54).
  - e. Valves of adjacent cells do **not** touch: *C. diadema*, *C. holsaticus*, and *C. seriacanthus* (Table 54).
  - f. Chains curved and joined in irregular spherical colonies: *C. socialis* and *C. radians*.
  - g. Unicellular species: *C. ceratosporus*, *C. simplex*, and *C. tenuissimus* (Table 55).
- 4. Cells with one chloroplast; unicellular; two, seldom three, setae per cell: *C. minimus* and *C. thronsdonii* (Table 56).

#### A. Subgenus *Phaeoceros*

- 1. Cells solitary or in short chains.

##### *Chaetoceros aequatorialis* Cleve (Plate 38, Table 46)

Synonym?: *Chaetoceros pendulus* Karsten.

References: Cleve, 1873a, p. 10, Fig. 9; Karsten, 1905, p. 118, Plate 15, Fig. 7; Karsten, 1907, p. 389, Plate 45, Fig. 1; Schmidt, 1920, Plate 325, Figs. 1 and 2; Hendey, 1937, p. 294.

Cells heterovalvate; upper valve with central depression or smoothly concave and lower valve with projecting corners and sometimes short tubular extension of the central process. Setae long, very coarse, emerging well inside valve margin, not abutting at point of emergence, proceeding outwards almost at right angles to pervalvar axis, then curving downwards. Setae of upper and lower valves almost parallel and armed with spines.

##### *Chaetoceros criophilus* Castracane (Plate 38, Table 46)

References: Castracane, 1886, p. 78; Mangin, 1915, p. 34, Figs. 13 and 14; Hendey, 1937, p. 295, Plate 13, Fig. 7; Hasle, 1968b, p. 7, Plate 10, Fig. 12, Map 4; Fryxell, 1989, p. 10, Figs. 33–38.

Cells heterovalvate; upper valve almost flat and lower valve curved. Setae long, coarse, and curved. Upper setae emerge at valve margin giving the

*Chaetoceros*

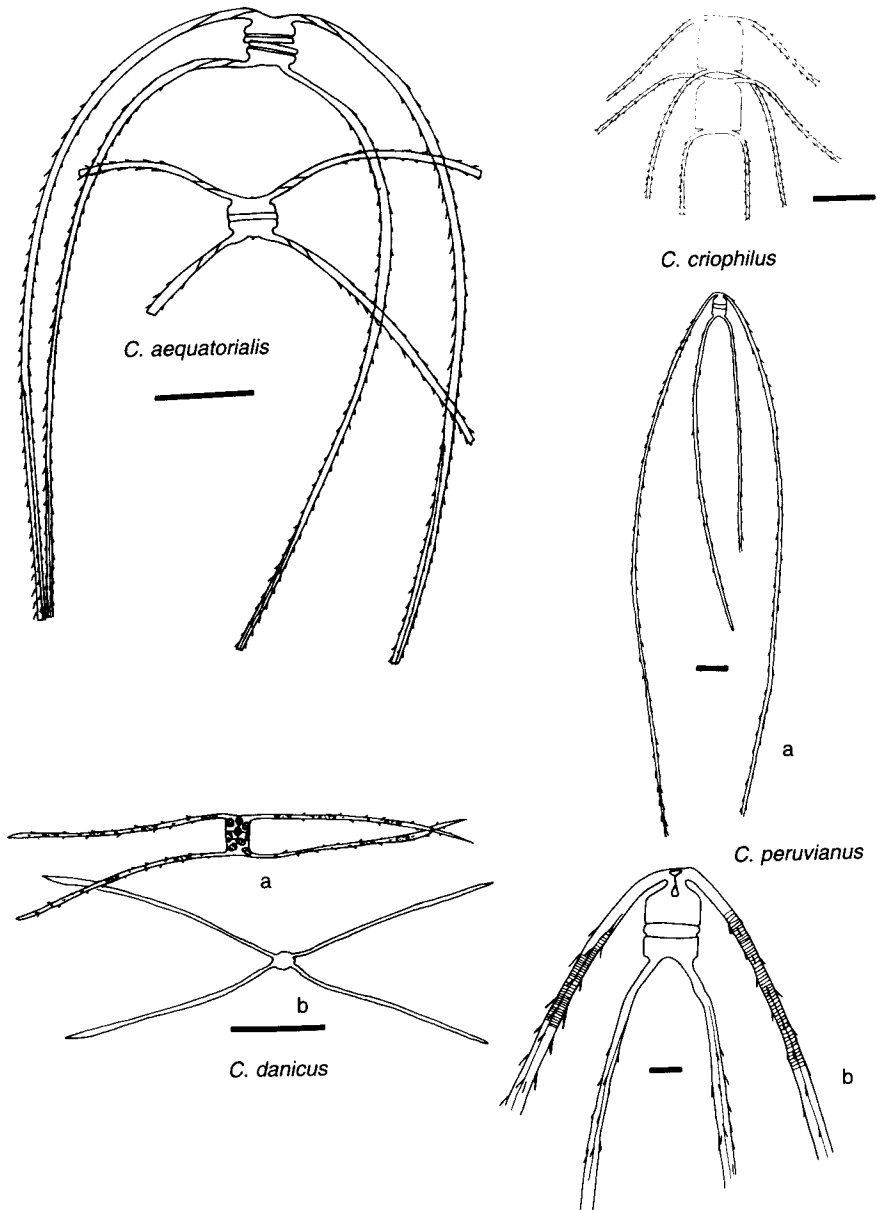

PLATE 38 *Chaetoceros aequatorialis*: cells in broad girdle view. After Schmidt (1920). Scale bar = 50  $\mu$ m. *Chaetoceros criophilus*: chain in broad girdle view. Scale bar = 50  $\mu$ m. *Chaetoceros danicus*: (a) cell in broad girdle view; (b) cell in valve view. Scale bar = 50  $\mu$ m. *Chaetoceros peruvianus*: (a) cell in broad girdle view. Scale bar = 50  $\mu$ m; (b) detail of cell in broad girdle view. Scale bar = 10  $\mu$ m.

TABLE 46 Morphometric Data of *Chaetoceros* spp. Appearing as Solitary Cells or Short Chains

Species	Apical axis ( $\mu\text{m}$ )
<i>C. aequatorialis</i>	ca. 25
<i>C. criophilus</i>	16–50
<i>C. danicus</i>	8–20
<i>C. peruvianus</i>	10–32
<i>C. rostratus</i>	10–37

appearance of being a continuation of valve surface; lower setae emerge inside valve margin. Chains with lanceolate; narrow apertures.

***Chaetoceros danicus* Cleve (Plate 38, Table 46)**

**References:** Cleve, 1889, p. 55; Hustedt, 1930, pp. 659 and 373; Cupp, 1943, p. 109, Fig. 65; Hendeby, 1964, p. 122, Plate 10, Fig. 5; Drebes, 1974, p. 66, Fig. 50; Koch & Rivera, 1984, p. 71, Figs. 53–56; Rines & Hargraves, 1988, p. 49, Figs. 95–99.

Cells isovalvate; valve surface flat. Setae long, stiff, perpendicular to peralvar or chain axis, and originating at valve margin. Chains with small apertures—terminal setae perpendicular to chain axis, intercalary setae basally directed toward one end of the chain then become parallel to the terminal setae. External part of central process a short, flattened tube (Koch & Rivera, 1984, Fig. 54, SEM).

***Chaetoceros peruvianus* Brightwell (Plate 38, Table 46)**

**Synonym:** *Chaetoceros chilensis* Krasske.

**References:** Brightwell, 1856, p. 107, Plate 7, Figs. 16–18; Brightwell, 1858b, p. 155, Plate 8, Figs. 9 and 10; Hustedt, 1930, p. 671, Figs. 380 and 381; Krasske, 1941, p. 266, Plate 4, Fig. 3, Plate 6, Figs. 1 and 2; Cupp, 1943, p. 113, Fig. 68; Hendeby, 1937, p. 296, Plate 13, Fig. 6; Hasle, 1960, p. 15, Fig. 2; Koch & Rivera, 1984, p. 69, Figs. 36–47.

Cells heterovalvate; upper valve rounded and lower valve flat. Setae of upper valve arising in peralvar direction from near valve center, abutting with a groove between them, turning sharply, and running backward in more or less outwardly convex curves. Setae of lower valve originating inside valve margin and slightly convex toward outside. Central process between the bases of the setae, subcentral in location; external part conical (Koch & Rivera, 1984, EM).



***Chaetoceros rostratus* Lauder (Table 46)**

**References:** Lauder, 1864b, p. 79, Fig. 10; Hustedt, 1930, p. 660, Fig. 374; Rines & Hargraves, 1988, p. 55, Figs. 105–107; Guiffré & Ragusa, 1988.

Cells isovalvate; valve surface flat or slightly convex. Cells in chains (two to six cells) held together by a central intervalvar connection [not a labiate-like process (Rines & Hargraves, 1988)]. Setae perpendicular to the perivalvar axis. Terminal cells heterovalvate i.e. terminal valve lacking the protuberance forming the intervalvar connection. External part of subcentrally located process a laterally compressed tube, slightly cone shaped (Guiffré & Ragusa, 1988, SEM).

**Distribution:**

- C. aequatorialis* and *C. rostratus*—warm water region.
- C. criophilus*—southern cold water region.
- C. danicus*—cosmopolitan?
- C. peruvianus*—warm water region to temperate.

2. Terminal setae differentiated from the others by length and direction.

***Chaetoceros atlanticus* Cleve (Plate 39, Table 47)**

**References:** Cleve, 1873b, p. 11, Plate 2, Fig. 8; Hustedt, 1930, p. 641, Figs. 363 and 364; Cupp, 1943, p. 103, Fig. 59; Evensen & Hasle, 1975, p. 157, Figs. 6–11; Koch & Rivera, 1984, p. 63, Figs. 1–5; Takano, 1990, pp. 282–283.

Cells rectangular in broad girdle view. Apertures hexagonal and smaller than the cells. Setae arising slightly within valve margin; basal part first narrow, then widened, and diagonally oriented. Inner setae almost straight. Terminal setae shorter than others, usually forming a V.

***Chaetoceros dichchaeta* Ehrenberg (Plate 39, Table 47)**

**References:** Ehrenberg, 1844b, p. 200; Mangin, 1922, p. 60, Fig. 6; Hendey, 1937, p. 291, Plate 6, Figs. 9 and 10; Evensen & Hasle, 1975, p. 157, Figs. 1–5; Koch & Rivera, 1984, p. 64, Figs. 6–12.

Cells rounded in broad girdle view. Apertures hexagonal to square, usually larger in perivalvar direction than the cell proper. Setae arising far inside valve margin; basal part long, more or less parallel to the chain axis, then bent outward at nearly right angles to chain axis; terminal setae later bent again so they are once more nearly parallel to chain axis.

---

**PLATE 39** *Chaetoceros atlanticus*: (a) chain. Scale bar = 50  $\mu\text{m}$ ; (b) detail of end cell in broad girdle view with external part of process. Scale bar = 10  $\mu\text{m}$ . After Cupp (1943). *Chaetoceros dichchaeta*: partial chain in broad girdle view. After Mangin (1922). Scale bar = 50  $\mu\text{m}$ . *Chaetoceros borealis*: chain in broad girdle view. Scale bar = 50  $\mu\text{m}$ . *Chaetoceros castracanei*: partial chain in broad girdle view. After Karsten (1905). Scale bar = 50  $\mu\text{m}$ .

Chaetoceros

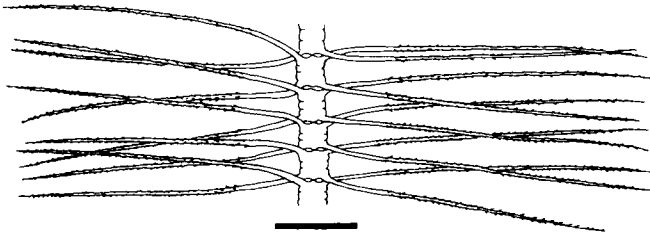
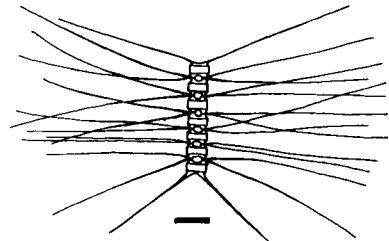
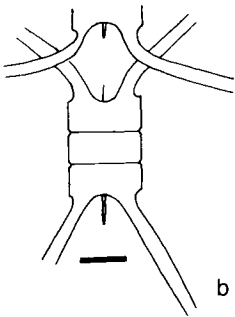
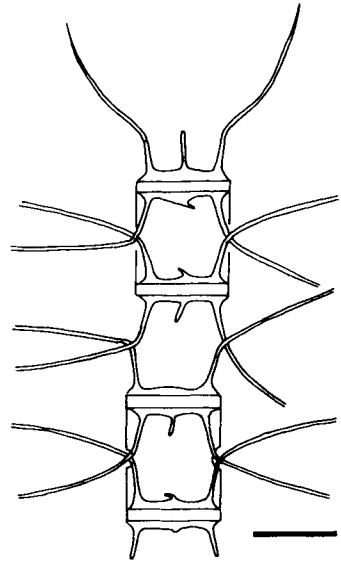
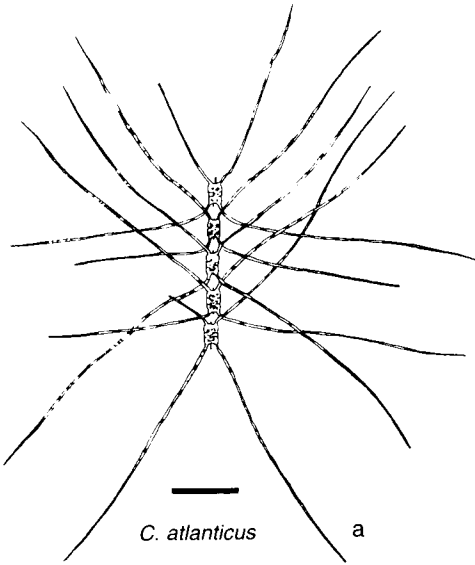

TABLE 47 Morphometric Data of *Chaetoceros* spp. with Terminal Setae Differing from Intercalary Setae

Species	Apical axis ( $\mu\text{m}$ )
<i>C. atlanticus</i>	10–40
<i>C. dichæta</i>	7–45

**Distribution:**

*C. atlanticus*—cosmopolitan—observed as far north as ca. 82°N (Heimdal, 1983) and as far south as ca. 50°S (Lange & Mostajo, 1985), observations from the southern cold water region are more complex (Hasle, 1969; Priddle & Fryxell, 1985).

*C. dichæta*—southern cold water region.

**Remarks:** Several varieties of *C. atlanticus* as well as of *C. dichæta* have been described. Those especially from the Antarctic, which may belong to *C. atlanticus*, need further study until their taxonomic position and geographic distribution can be settled.

3. Terminal setae not differentiated from the others.

*Chaetoceros borealis* Bailey (Plate 39, Table 48)

**References:** Bailey, 1854, p. 8, Figs. 22 and 23; Hustedt, 1930, p. 661, Fig. 375; Hendeny, 1964, p. 120, Plate 18, Fig. 2; Drebes, 1974, p. 66, Fig. 51;

TABLE 48 Morphometric Data of *Chaetoceros* spp. without Special Terminal Setae

Species	Apical axis ( $\mu\text{m}$ )
<i>C. borealis</i>	12–46
<i>C. castracanei</i>	ca. 15
<i>C. coarctatus</i>	30–44
<i>C. concavicornis</i>	12–30
<i>C. convolutus</i>	10–27
<i>C. dadayi</i>	10–15
<i>C. densus</i>	10–55
<i>C. eibenii</i>	25–78
<i>C. tetrastichon</i>	10–20

Evensen & Hasle, 1975, p. 158, Figs. 12–14; Rines & Hargraves, 1988, p. 45, Fig. 93.

Chains straight, not twisted. Cells isovalvate; apertures elliptical to hexagonal. Setae arising well inside valve margin having a distinct basal part; point of fusion near chain edge, setae often crossing each other. External part of central process a short tube (Evensen & Hasle, 1975, EM).

***Chaetoceros castracanei* Karsten (Plate 39, Table 48)**

**References:** Karsten, 1905, p. 116, Plate 15, Fig. 1; Priddle & Fryxell, 1985, p. 26.

Chains straight. Cells isovalvate. Apertures narrow, almost closed by a central valve protuberance. Setae emerging within valve margin, fused outside chain edge, and perpendicular to chain axis in their outer part.

***Chaetoceros coarctatus* Lauder (Plate 40, Table 48)**

**References:** Lauder, 1864b, p. 79, Fig. 8; Hustedt, 1930, p. 655, Fig. 370; Hendey, 1937, p. 293, Plate 5, Figs. 7 and 8; Cupp, 1943, p. 107, Fig. 62; Hernández-Becerril, 1991b.

Chains long and robust. Cells isovalvate. Apertures almost absent. Valve surface flat. Posterior terminal setae large, strongly curved, and shorter than the others and anterior terminal setae less robust. Usually found with a species of *Vorticella* attached. Eighteen to 22 small, slit-like processes on each valve (Hernández-Becerril, 1991b, EM).

***Chaetoceros concavicornis* Mangin (Plate 40, Table 48)**

**References:** Mangin, 1917, p. 9, Figs. 5–7; Hustedt, 1930, p. 665, Figs. 376 and 377; Cupp, 1943, p. 109, Fig. 66; Hendey, 1964, p. 122, Plate 9, Fig. 1; Evensen & Hasle, 1975, p. 158, Figs. 15–22.

Chains straight. Cells heterovalvate; upper valve rounded, setae arising from near center; lower valve flat, setae emerging from inside valve margin. Apertures trapezoid like. Girdle zone narrow (less than one-third of the length of peralvar axis). Setae thin at base, wider outward, and all bent toward lower end of chain, and outside line concave. External part of central process a short tube (Evensen & Hasle, 1975, EM).

***Chaetoceros convolutus* Castracane (Plate 41, Table 48)**

**References:** Castracane, 1886, p. 78; Hustedt, 1930, p. 668, Fig. 378; Cupp, 1943, p. 110, Fig. 67; Fryxell & Medlin, 1981, p. 9, Figs. 43–49; Koch & Rivera, 1984, p. 67, Figs. 23–35; Rines & Hargraves, 1988, p. 47, Fig. 94.

Chains sometimes twisted about peralvar axis. Cells heterovalvate, upper valve vaulted, setae arising from near center; lower valve flat, setae emerging from well inside valve margin. Setae of the lower valves bent

*Chaetoceros*

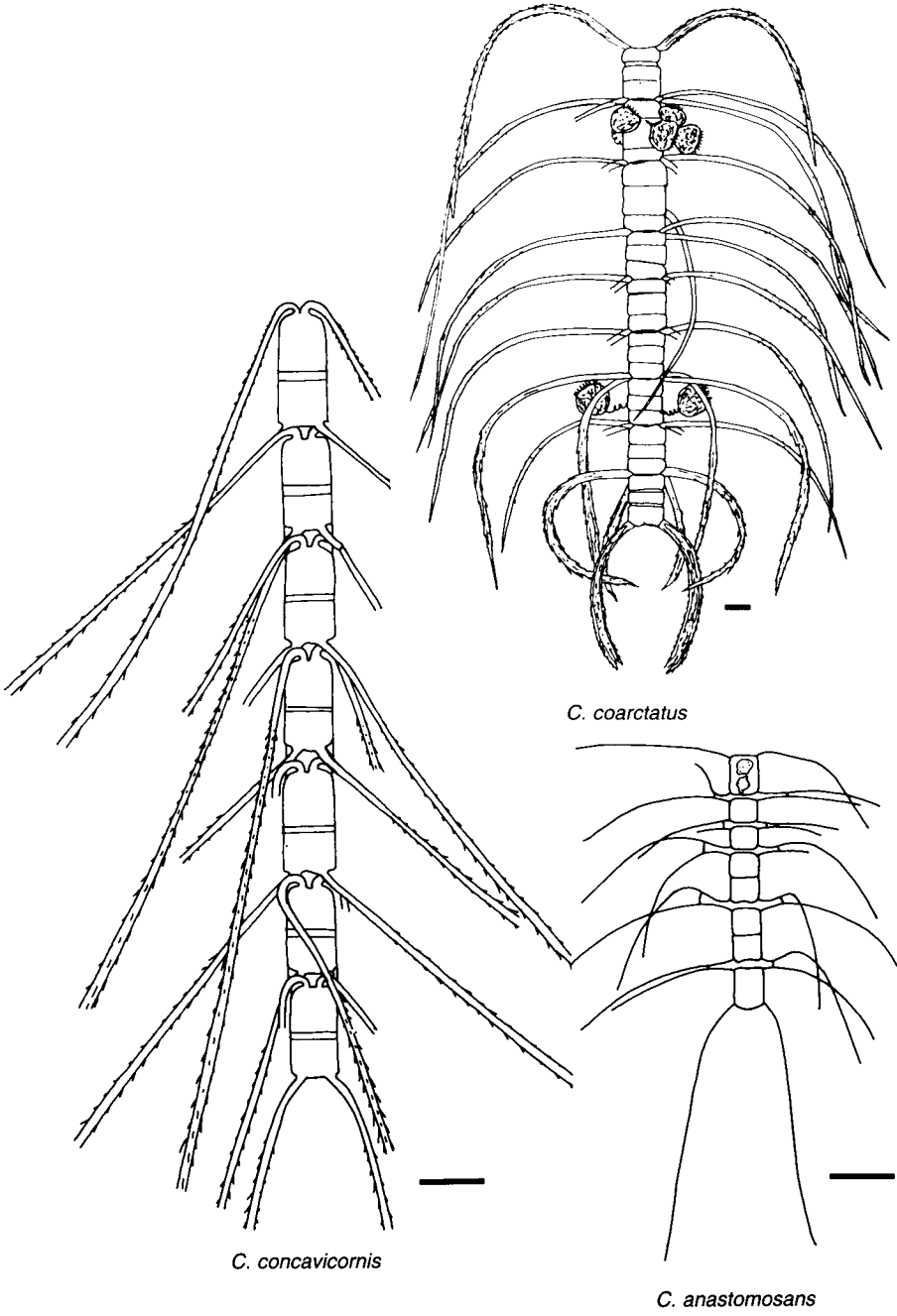

toward the same end of the chain. Sibling setae often twisted at their basal part thus partially or wholly covering the apertures. Sibling valves held together by siliceous flaps on setae of upper valve (Fryxell & Medlin, 1981; Koch & Rivera, 1984, EM). Girdle zone fairly broad (about one-third of the length of perivalvar axis). Setae not increasing in width from base and outward (cf. *C. concavicornis*). External part of central process short and tubular (Fryxell & Medlin, 1981; Koch & Rivera, 1984, EM).

***Chaetoceros dadayi* Pavillard (Plate 41, Table 48)**

References: Pavillard, 1913, p. 131, Fig. 2b; Hustedt, 1930, p. 658, Fig. 372; Cupp, 1943, p. 109, Fig. 64; Hernández-Becerril, 1992c, p. 367, Figs. 9–22.

Recognized and differentiated from *C. tetrastichon* by formation and direction of setae (Cupp, 1943). Setae arising from valve margin without a basal part. Setae on one side of the chain short and on the other side very long with some running toward one end of the chain and some toward the other. Usually found with a tintinnid attached.

***Chaetoceros densus* (Cleve) Cleve (Table 48)**

Basionym: *Chaetoceros borealis* var. *densus* Cleve.

References: Cleve, 1897a, p. 20, Plate 1, Figs. 3 and 4; Cleve, 1901a, p. 299; Hustedt, 1930, p. 651, Fig. 368; Drebes, 1974, p. 64, Fig. 48; Rines & Hargraves, 1988, p. 50, Figs. 100 and 101.

Cells tightly packed together in chains. Cells isovalvate; valve surface slightly convex. Apertures narrowly lanceolate. Setae perpendicular to chain axis or bent slightly toward chain ends, diverging strongly from apical plane.

***Chaetoceros eibenii* Grunow in Van Heurck (Plate 41, Table 48)**

References: Van Heurck, 1880–1885, Plate 82, Figs. 9 and 10; Pavillard, 1921, p. 469, Figs. 1–11; Hustedt, 1930, p. 653, Fig. 369; Cupp, 1943, p. 106, Fig. 61; Drebes, 1974, p. 64, Fig. 49; Koch & Rivera, 1984, p. 65, Figs. 13–22; Rines & Hargraves, 1988, p. 52, Figs. 102–104.

Cells isovalvate; valve surface slightly concave with a small central process on each valve (LM). Apertures lanceolate to hexagonal. Setae generally bent toward nearest end of the chain. Resting spores formed inside lateral auxospores (“in need of further study” according to Rines & Hargraves, 1988). External part of central process laterally flattened; internally visible as a slit (Koch & Rivera, 1984, Figs. 17–20, SEM).

Chaetoceros

PLATE 41 *Chaetoceros convolutus*: chain in broad girdle view. *Chaetoceros dadayi*: with tintinnid. After Cupp (1943). *Chaetoceros tetrastichon*: chain. After Cupp (1943). *Chaetoceros flexuosus*: chain. *Chaetoceros eibonii*: Chain. After Cupp (1943). Scale bars = 20  $\mu\text{m}$ .

***Chaetoceros tetrastichon* Cleve (Plate 41, Table 48)**

**References:** Cleve, 1897a, p. 22, Plate 1, Fig. 7; Hustedt, 1930, p. 657, Fig. 371; Cupp, 1943, p. 108, Fig. 63; Hendey, 1964, p. 123, Plate 11, Fig. 1; Hernández-Becerril, 1992c, p. 367, Figs. 1–8.

Chains straight. Cells isovalvate; valve surface flat. Apertures almost absent. Setae emerging from valve margin, curved outward, almost at right angles to chain, toward ends turned nearly parallel to chain axis.

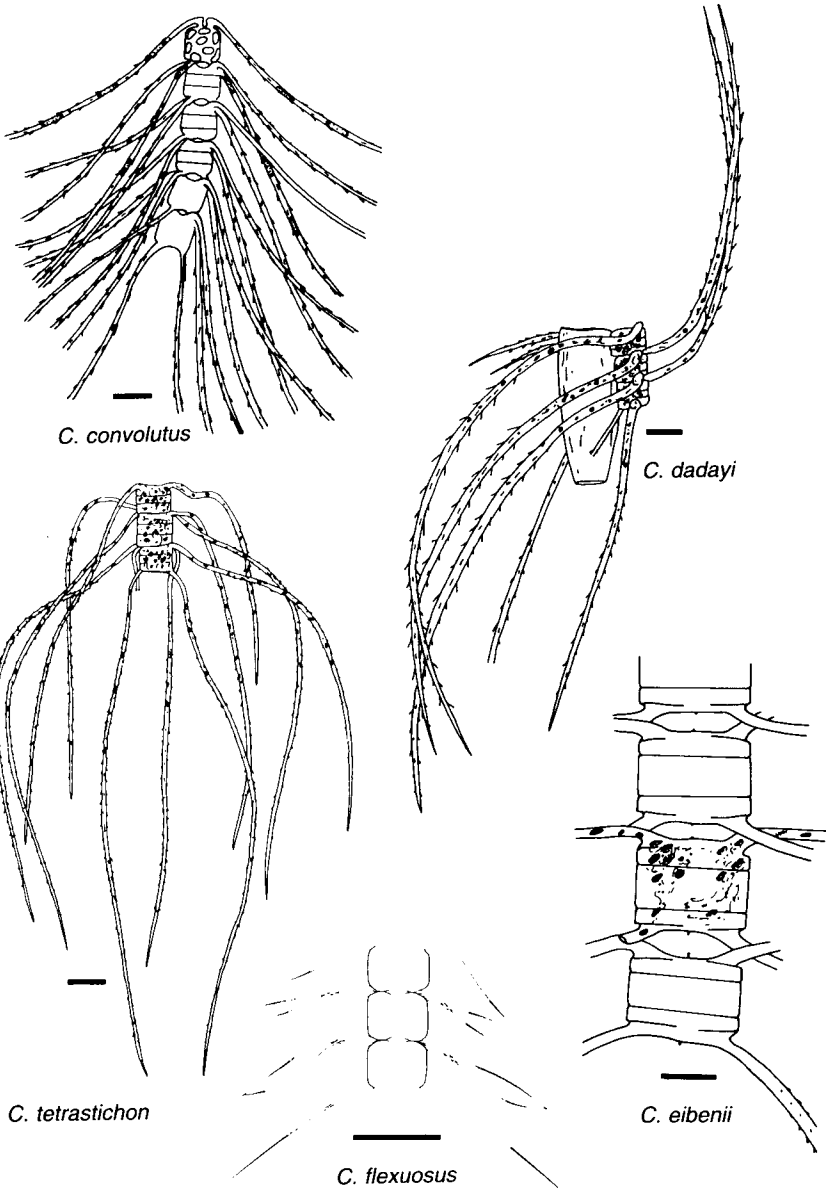
One pair of setae generally curve more strongly and may be attached to a tintinnid (Hernández-Becerril, 1992b).

**Distribution:**

*C. borealis*—cosmopolitan?, probably most common in temperate and cold water.

*C. concavicornis*—cosmopolitan but absent from southern cold water region, common in northern cold water region and temperate waters.

*C. convolutus* and *C. densus*—cosmopolitan, probably most common in temperate waters.

*C. castracanei*—southern cold water region.

*C. coarctatus*, *C. dadayi*, and *C. tetrastichon*—warm water region.

*C. eibenii*—warm water region to temperate.

**Remarks:** It may be questioned whether *C. hendeyi* Mangin is a separate species endemic to the southern cold water region or conspecific with *C. borealis*. It should be noted that specimens including at the same time features specific to *C. borealis* and *C. concavicornis*, are present in the northern cold water region (Gran, 1904; Braarud, 1935; Holmes, 1956). Based on these findings, Braarud (1935, p. 92) proposed *C. concavicornis* to be a form of *C. borealis*. *Chaetoceros convolutus* and *C. concavicornis* are similar in gross morphology as are *C. tetrastichon* and *C. dadayi*; distinctive characters have been pointed out previously.

4. Setae not fused.

***Chaetoceros flexuosus* Mangin (Plate 41)**

**References:** Mangin, 1915, p. 45, Fig. 27; Hasle, 1968b, p. 7, Plate 10, Fig. 14, Map 4; Fryxell & Medlin, 1981, p. 6, Figs. 1–5 and 16–28.

Cells held together in colonies by sibling setae twisted around each other in one or two turns (no fusion of silica, Fryxell & Medlin, 1981, EM observations). Apertures narrow but conspicuous. A process located toward one margin from the valve center, externally forms a cone cut at the top (Fryxell & Medlin, 1981, SEM).

**Morphometric data:** Pervalvar axis, 9–20  $\mu\text{m}$ ; apical axis, 9–15  $\mu\text{m}$ .

**Distribution:** Southern cold water region.

**Remarks:** *Chaetoceros flexuosus* has been found crowded with chloroplasts extending into the setae (Fryxell & Medlin, 1981). Despite the extremely



delicate setae it thus belongs in *Phaeoceros*, which is a taxonomic position also supported by the presence of a central process on every valve.

### B. Subgenus *Hyalochaete*

#### 1a. Four to 10 chloroplasts.

#### *Chaetoceros decipiens* Cleve (Plate 42, Table 49)

**References:** Cleve, 1873b, p. 11, Plate 1, Figs. 5a and 5b; Hustedt, 1930, p. 675, Fig. 383; Cupp, 1943, p. 115, Fig. 70; Hendey, 1964, p. 123, Plate 12, Fig. 2; Drebes, 1974, p. 69, Fig. 52a; Evensen & Hasle, 1975, p. 161, Figs. 55–69; Rines & Hargraves, 1988, p. 75, Figs. 148, 149, and 152.

Chains straight and stiff. Valve corners touching those of adjacent cell. Apertures slit-like to broadly lanceolate. Sibling setae fused for a length several times their diameter and then diverging in perivalvar direction. Terminal setae thicker than the others, initially divergent, then bent, becoming parallel to chain axis. No resting spores. Central process with no distinct protrusion on the outside and a labiate structure on the inside (Evensen & Hasle, 1975, Figs. 63–66, EM).

#### *Chaetoceros lorenzianus* Grunow (Plate 42, Table 49)

**References:** Grunow, 1863, p. 157, Plate 5, Fig. 13; Hustedt, 1930, p. 679, Fig. 385; Cupp, 1943, p. 118, Fig. 71; Hendey, 1964, p. 124, Plate 16, Fig. 1; Rines & Hargraves, 1988, p. 85, Figs. 178–184.

Chains straight and stiff. Apertures elliptical to oval. Sibling setae fused only at the point of exit from margin; setae with distinct transverse rows of pores. Terminal setae divergent in broad girdle view for their whole length. Primary valve of resting spores with two conical protuberances which branch repeatedly and dichotomously at the tips; secondary valve smooth.

#### *Chaetoceros mitra* (Bailey) Cleve (Plate 42, Table 49)

**Basionym:** *Di cladia mitra* Bailey.

**Synonym:** *Di cladia groenlandica* Cleve.

**References:** Bailey, 1856, p. 4, Plate 1, Fig. 6; Cleve, 1873b, p. 12, Plate 2, Figs. 1 and 2; Cleve, 1896a, p. 8, Plate 2, Figs. 1 and 2; Hustedt, 1930, p. 677, Fig. 384; Hasle & Syvertsen, 1990b, p. 288, Figs. 5–9 and 11.

Chains straight. Apertures narrowly lanceolate and slightly constricted centrally. Setae crossing only at the point of exit from margin, setae without distinct structure (LM). Terminal setae parallel or convergent in broad girdle view and divergent in narrow girdle view. Primary valve of resting spores with two conical protuberances, terminating into a stalk which branches dichotomously at the tip; secondary valve smooth.

**Remarks:** Intermediate forms between *C. decipiens* and *C. lorenzianus* exist (Rines & Hargraves, 1988). Usually the two species are distinguished by the

Chaetoceros

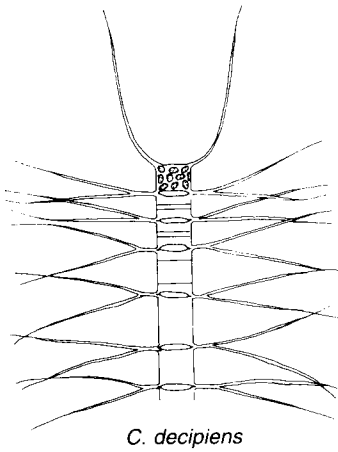

*C. decipiens*

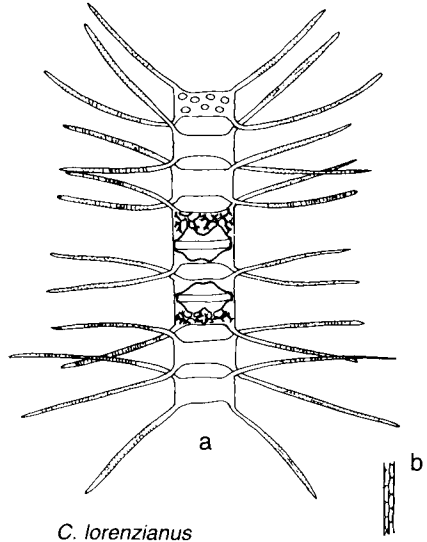

*C. lorenzianus*

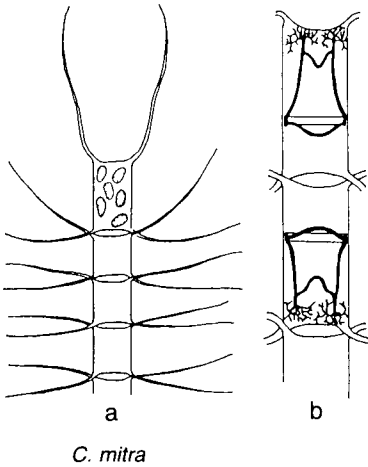

*C. mitra*

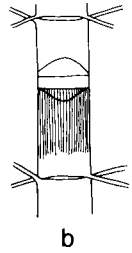

b

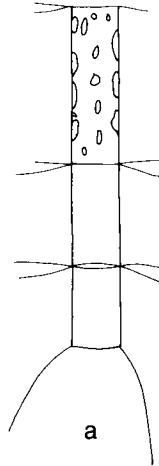

a

*C. teres*

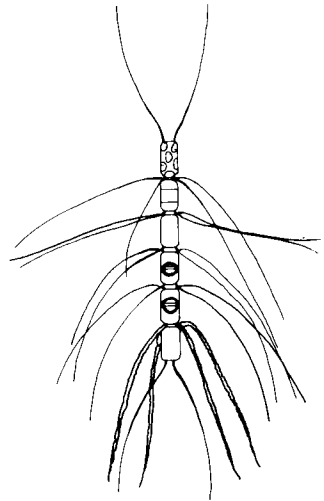

*C. compressus*

**PLATE 42** *Chaetoceros decipiens*: setae fused at base. *Chaetoceros lorenzianus*: (a) chain; (b) detail of seta. Partly after Cupp (1943). *Chaetoceros mitra*: (a) partial chain with chloroplasts; (b) cells with resting spores. After Hustedt (1930). *Chaetoceros teres*: (a) chain with chloroplasts; (b) cell with resting spore. After Hustedt (1930). *Chaetoceros compressus*: chain with one pair of thickened intercalary setae and resting spores. Scale bars = 20  $\mu$ m.

TABLE 49 Morphometric Data of *Chaetoceros* spp. with More Than Two Chloroplasts

Species	Apical axis ( $\mu\text{m}$ )
<i>C. decipiens</i>	9–84
<i>C. lorenzianus</i>	7–80
<i>C. mitra</i>	25–80
<i>C. compressus</i>	7–40
<i>C. teres</i>	18–50
<i>C. lauderi</i>	18–24

coarser structure of the setae and the presence of resting spores in *C. lorenzianus* in addition to the fused setae of *C. decipiens*. *Chaetoceros mitra* also lacks this fusion and is furthermore distinguished from *C. decipiens* and from *C. lorenzianus* by its terminal setae being divergent and lying almost on the transapical axis. Differences in the distribution pattern support the status of the three species as separate taxa.

1b. Numerous small plate-like chloroplasts.

*Chaetoceros compressus* Lauder (Plate 42, Table 49)

**References:** Lauder, 1864b, p. 78, Plate 8, Figs. 6a and 6b; Hustedt, 1930, p. 684, Figs. 388 and 389; Cupp, 1943, p. 119, Fig. 74; Hendey, 1964, p. 125, Plate 16, Fig. 5; Drebes, 1974, p. 72, Fig. 56; Rines & Hargraves, 1988, p. 64, Figs. 131–134 and 218; Rines & Hargraves, 1990.

Chains often very long and straight with cells more or less twisted about chain axis. Apertures variable in shape—four or six-sided to slit like.

Setae arising well inside valve margin; basal part distinct; point of crossing near chain edge. Two types of inner setae: most are thin, some pairs are shorter, thickened, spirally undulate, covered with small spines, and strongly directed toward one end of chain. Resting spores smooth, primary valve highly vaulted and secondary valve slightly vaulted.

**Remarks:** Terminal valves of *C. compressus* var. *hirtisetus* Rines & Hargraves usually have three processes, and the thin intercalary setae have fine, long, hair-like siliceous spines (Rines & Hargraves, 1990).

*Chaetoceros teres* Cleve (Plate 42, Table 49)

**References:** Cleve, 1896b, p. 30, Fig. 7; Hustedt, 1930, p. 681, Fig. 386; Cupp, 1943, p. 118, Fig. 72; Hendey, 1964, p. 124, Plate 10, Fig. 3;

Drebes, 1974, p. 70, Figs. 53 and 54; Rines & Hargraves, 1988, p. 102, Fig. 203.

Chains straight and tight. Cells cylindrical. Apertures narrow slits. Inner setae more or less perpendicular to chain axis; terminal setae widely divergent. Resting spores with evenly vaulted and smooth primary valve; secondary valve slightly vaulted, often with a ring of long hair-like siliceous spines.

***Chaetoceros lauderi* Ralfs in Lauder (Table 49)**

**References:** Lauder, 1864b, p. 77, Plate 8, Figs. 4a and 4b; Hustedt, 1930, p. 683, Fig. 387; Cupp, 1943, p. 118, Fig. 73; Hendey, 1964, p. 125, Plate 13, Fig. 3; Drebes, 1974, p. 72, Fig. 55; Rines & Hargraves, 1988, p. 84, Figs. 170–173.

Chains somewhat twisted. Otherwise distinguished from *C. teres* by the shape of the primary valves of the resting spores, which are highly vaulted or capitate and spiny.

**Distribution:**

*C. decipiens*—cosmopolitan.

*C. lorenzianus*—warm water region.

*C. mitra*—northern cold water region.

*C. compressus* and *C. lauderi*—warm water region to temperate.

*C. teres*—northern cold water region to temperate.

**Remarks:** *Chaetoceros compressus* is a common species, often occurring in great abundances. *Chaetoceros teres* and *C. lauderi* are less frequently recorded, and they are differentiated by their resting spores and distribution.

***Chaetoceros neglectus* Karsten (Plate 44)**

**References:** Karsten, 1905, p. 119, Plate 16, Fig. 5; Hasle, 1968b, p. 7, Plate 10, Fig. 13, Map 4; Priddle & Fryxell, 1985, p. 46.

Weakly silicified; one chloroplast, one type of inner setae, and one resting spore valve with setae extending into the setae of the parent cell (G. Hasle and E. Syvertsen, personal observations). Except for this difference, the description of *C. compressus* is also valid for *C. neglectus*.

**Morphometric data:** Apical axis, 10–15  $\mu\text{m}$ .

**Distribution:** Southern cold water region.

2. Cells with two chloroplasts.

***Chaetoceros didymus* Ehrenberg (Plate 43, Table 50)**

**References:** Ehrenberg, 1845b, p. 75; Hustedt, 1930, p. 688, Figs. 390 and 391; Cupp, 1943, p. 121, Fig. 75; Hendey, 1964, p. 125, Plate 17, Fig. 2; von Stosch et al., 1973; Drebes, 1974, p. 73, Fig. 57; Rines & Hargraves, 1988, p. 77, Figs. 154–163; Takano, 1990, pp. 288–289; Hernández-Becerril, 1991c.

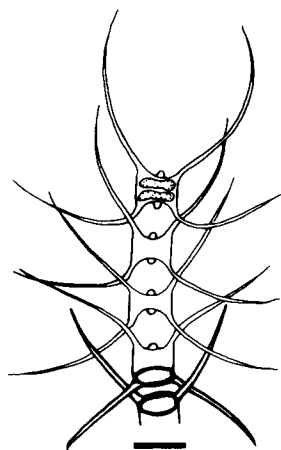
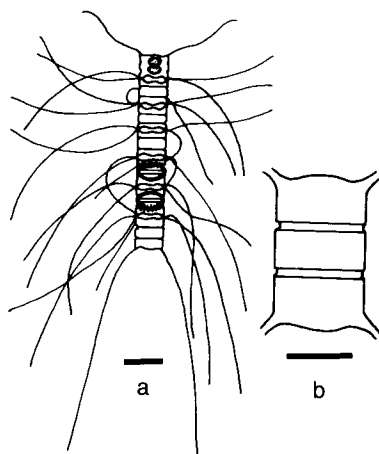
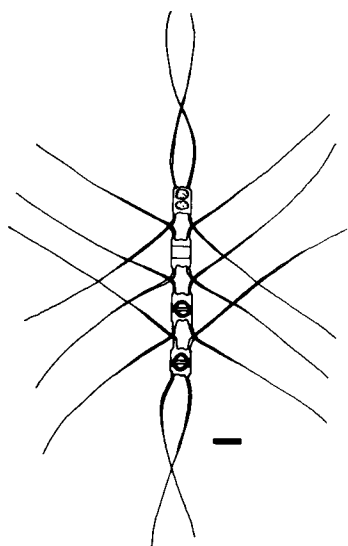
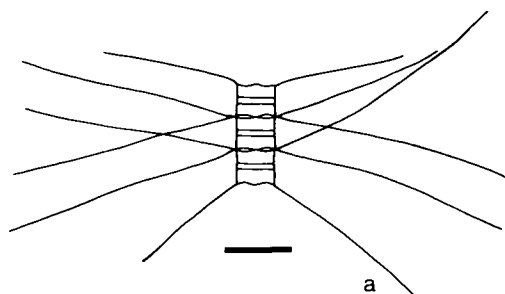
*Chaetoceros**C. didymus**C. constrictus**C. lacinosus*

a

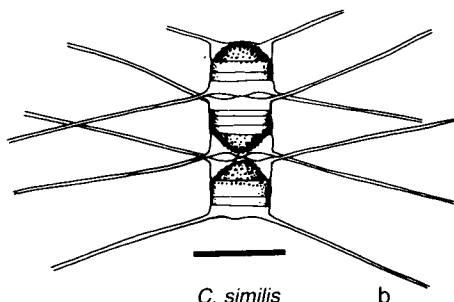
*C. similis*

b

**PLATE 43** *Chaetoceros didymus*: valve protrusions and resting spores. *Chaetoceros constrictus*: (a) chain with two resting spores; (b) detail of cell with strong constriction between valve mantle and band. *Chaetoceros lacinosus*: chain with two resting spores. *Chaetoceros similis*: (a) chain; (b) chain with partly developed resting spores. After Hustedt (1930). Scale bars = 20  $\mu\text{m}$ .

TABLE 50 Morphometric Data of *Chaetoceros* spp. with Two Chloroplasts

Species	Apical axis ( $\mu\text{m}$ )
<i>C. anastomosans</i>	8–20
<i>C. constrictus</i>	12–36
<i>C. didymus</i>	10–40
<i>C. lacinosus</i>	9–42
<i>C. similis</i>	7–17

Chains straight. Apertures large and partly filled by the valve protuberance. Setae arising from corners of cells, crossing at their bases or farther out, sometimes far outside chain edge. Each chloroplast with a pyrenoid located in the protuberance. Resting spores smooth; within pairs of resting spore parent cells with short, thick setae on hypovalve.

**Remarks:** Rines & Hargraves (1988) interpreted *C. didymus* as a complex of taxa including a number of varieties. Based on EM investigations Hernández-Becerril (1991c) suggested that *Chaetoceros protuberans* Lauder should be regarded as a separate species and not as a variety of *C. didymus*. According to the same investigation *C. didymus* has a centrally located process consisting of a slit-like hollow with a very short projection to the outside; a similar process is located at the center of the typical protuberance of *C. protuberans*.

***Chaetoceros constrictus* Gran (Plate 43, Table 50)**

**References:** Gran, 1897b, p. 17, Plate 1, Figs. 11-13, Plate 3, Fig. 42; Hustedt, 1930, p. 694, Fig. 395; Cupp, 1943, p. 122, Fig. 76; Hendey, 1964, p. 126, Plate 9, Fig. 2; Rines & Hargraves, 1988, p. 67, Figs. 128–130.

Chains straight. Valve poles drawn up; corners of adjacent cells touching. Apertures lanceolate, slightly narrowing in center. Terminal setae diverging at an acute angle. Constriction between valve mantle and band conspicuous. Resting spores with unequally vaulted, spiny valves.

***Chaetoceros lacinosus* Schütt (Plate 43, Table 50)**

**References:** Schütt, 1895, p. 38, Plate 4, Fig. 5; Hustedt, 1930, p. 701, Fig. 401; Cupp, 1943, p. 128, Fig. 80; Hendey, 1964, p. 127, Plate 13, Fig. 2; Evensen & Hasle, 1975, p. 160, Figs. 42–45; Rines & Hargraves, 1988, p. 83, Figs. 167–169.

Chains straight and loose. Setae thin; basal part parallel to chain axis and then perpendicular to chain axis; far outer part usually bent toward one

chain end. Terminal setae different from the others—almost parallel in broad girdle view and more diverging in narrow girdle view. Apertures high, elliptical, and square to rectangular. Each chloroplast with a central pyrenoid. Resting spore valves smooth; primary valve more or less highly vaulted and secondary valve almost flat to highly vaulted. Central process built as that in *C. curvisetus* but located near the edge of valve face (Evensen & Hasle, 1975, EM).

***Chaetoceros similis* Cleve (Plate 43, Table 50)**

References: Cleve, 1896b, p. 30, Fig. 1; Hustedt, 1930, p. 720, Fig. 411; Cupp, 1943, p. 135, Fig. 90; Hendey, 1964, p. 130, Plate 15, Fig. 2; Rines & Hargraves, 1988, p. 94, Figs. 222 and 223.

Short and straight chains. Apertures narrow and divided into two parts by a central, raised region of the valve. Setae arising from cell corners, directed diagonally toward chain ends, crossing outside chain margin. Terminal setae parallel to the others. Resting spores pear shaped with small spines.

***Chaetoceros anastomosans* Grunow in Van Heurck (Plate 40, Table 50)**

References: Van Heurck, 1880-1885, Plate 82, Figs. 6-8; Hustedt, 1930, p. 743, Fig. 429; Cupp, 1943, p. 140, Fig. 96; Drebes, 1974, p. 81, Fig. 65 as *C. externus* Gran.

Chains straight or slightly curved, mostly loose. Setae thin, arising from cell corners, variously bent, and not crossing but connected by perivalvarly directed bridges. Apertures wide.

**Distribution:**

*C. anastomosans* and *C. didymus*—warm-water region to temperate.

*C. constrictus*, *C. lacinosus*, and *C. similis*—northern cold water region to temperate?

**Remarks:** Except for the two chloroplasts these species have few characters in common, whereas each of them is readily identified by their specific features. *Chaetoceros vanheurckii* Gran is very similar to *C. constrictus*, differing only by some minor features of the resting spores. *Chaetoceros pelagicus* Cleve and *C. brevis* Schütt have both one chloroplast but are otherwise similar to *C. lacinosus*. Resting spores are unknown for *C. pelagicus*, those of *C. brevis* and *C. lacinosus* are similar. There seems to be a general consensus that positive identification of *C. brevis* is problematic.

3. Cells with one chloroplast.

3a. Chains curved or helical; intercalary setae all bent in one direction.

***Chaetoceros curvisetus* Cleve (Plate 44, Table 51)**

**References:** Cleve, 1889, p. 55; Hustedt, 1930, p. 737, Fig. 426; Cupp, 1943, p. 137, Fig. 93; Hendeby, 1964, p. 133, Plate 17, Fig. 6; Drebes, 1974, p. 79, Fig. 63; Evensen & Hasle, 1975, p. 159, Figs. 23–26; Rines & Hargraves, 1988, p. 71, Figs. 141 and 142.

Adjacent cells in chains connected by drawn up poles of the concave valves; basal part of setae short or missing. All setae directed toward the outside of the chain spiral (best seen in narrow girdle view). Apertures a lanceolate slit, elliptical, or nearly circular. Resting spores smooth; primary valve evenly rounded and secondary valve less rounded to almost flat. Central process short, flattened with no protrusion or thickening on the inside (Evensen & Hasle, 1975, Figs. 25 and 26).

***Chaetoceros debilis* Cleve (Plate 44, Table 51)**

**References:** Cleve, 1894a, p. 13, Plate 1, Fig. 2; Hustedt, 1930, p. 740, Fig. 428; Cupp, 1943, p. 138, Fig. 95; Hendeby, 1964, p. 133, Plate 14, Fig. 7; Drebes, 1974, p. 81, Fig. 64; Evensen & Hasle, 1975, p. 159, Figs. 27–32; Rines & Hargraves, 1988, p. 72, Figs. 143–147; Takano, 1990, pp. 286–287.

Valves flat or slightly convex. Valves of adjacent cells in chains do not touch. Basal part of setae conspicuous. Setae crossing slightly outside chain edge, extending outward from the spiral. Apertures almost rectangular or slightly constricted in the middle. Primary valve of resting spores with two humps and two setae extending into the corners of the parent cell. Secondary valve smooth or with setae.

***Chaetoceros pseudocurvisetus* Mangin (Plate 44, Table 51)**

**References:** Mangin, 1910, p. 350, Fig. 3, II, Fig. 4, II; Hustedt, 1930, p. 739, Fig. 427; Cupp, 1943, p. 138, Fig. 94; Hendeby, 1964, p. 134, Plate 18, Fig. 1; Fryxell, 1978c, p. 68, Figs. 22–26; Rines & Hargraves, 1988, p. 89, Figs. 185–191; Takano, 1990, pp. 290–291.

Cells in colonies joined by fusion of sibling setae and at the edges of valves by four elevated projections leaving a large lenticular aperture in the center between cells in broad girdle view.

**Distribution:**

- C. curvisetus*—cosmopolitan, mainly temperate and warm waters.
- C. debilis*—cosmopolitan, mainly cooler waters.
- C. pseudocurvisetus*—warm water region.

- 3b. Resting spores in pairs; resting spore parent cells with fused hypovalvar setae and no apertures.

***Chaetoceros cinctus* Gran (Plate 45, Table 52)**

**References:** Gran, 1897b, p. 24, Plate 2, Figs. 23–27; Hustedt, 1930, p. 748, Fig. 432; Cupp, 1943, p. 142, Fig. 98; Hendeby, 1964, p. 135, Plate 11, Fig. 4.



Chaetoceros

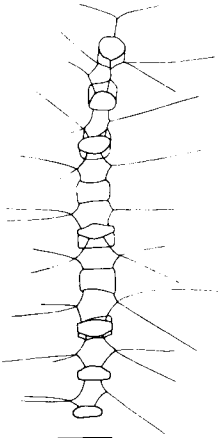

*C. neglectus*

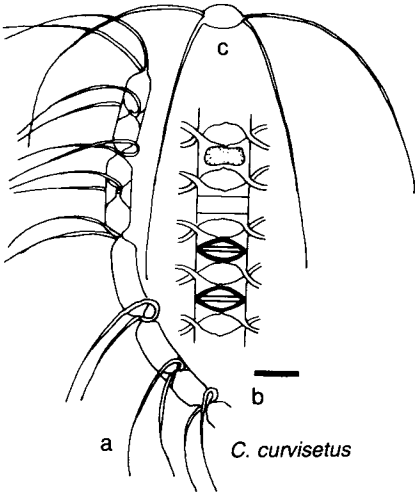

*C. curvisetus*

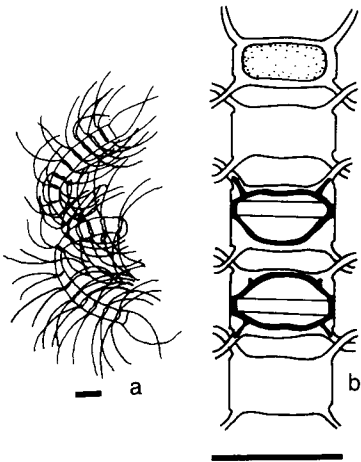

*C. debilis*

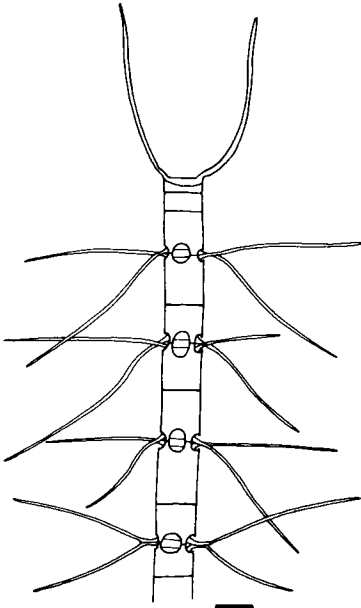

*C. pseudocurvisetus*

TABLE 51 Morphometric Data of *Chaetoceros* spp. with One Chloroplast and Curved or Helical Chains

Species	Apical axis ( $\mu\text{m}$ )
<i>C. curvisetus</i>	7–30
<i>C. debilis</i>	8–40
<i>C. pseudocurvisetus</i>	12–50

Chains straight or weakly curved. Setae thin, arising somewhat inside valve margin; basal part short, diagonal, and conspicuous. Setae crossing outside chain edge, perpendicular to chain axis. Apertures fairly large and rectangular. Resting spore setae curved to surround the cell like a girdle.

***Chaetoceros furcellatus* Bailey (Plate 45, Table 52)**

**References:** Bailey, 1856, Plate 1, Fig. 4; Hustedt, 1930, p. 749, Fig. 433.

Chains straight or weakly curved. Setae thin, arising slightly inside valve margin; short and diagonal basal part. Setae of vegetative cells crossing slightly outside chain edge, irregularly oriented toward chain axis. Apertures rectangular, slightly compressed in center. Resting spores smooth, within resting spore parent cells with coarse hypoalvar setae (E. Syvertsen, personal observations), which are often fused for a fairly long distance, perpendicular to chain axis, twisting, branching, and diverging at a low angle.

***Chaetoceros radicans* Schütt (Plate 45, Table 52)**

**References:** Schütt, 1895, p. 48, Fig. 27; Hustedt, 1930, p. 746, Fig. 431; Cupp, 1943, p. 141, Fig. 97; Hendey, 1964, p. 134, Plate 14, Fig. 4; Drebes, 1974, p. 82, Fig. 66; Fryxell & Medlin, 1981, p. 8, Figs. 9–15, and 29–35; Rines & Hargraves, 1988, p. 90, Figs. 192–198.

Chains straight or slightly curved, twisted about the chain axis. Setae arising from just inside the valve margin, all bent out transversely. Intercalary setae with hair-like siliceous spines; terminal setae without spines. Apertures narrow and elliptical with central constriction. Hypoalvar setae of resting spore parent cell thick and smooth and separate after the fused space to surround the cell like a girdle.

---

**PLATE 44** *Chaetoceros neglectus*: part of chain with resting spores. *Chaetoceros curvisetus*: (a) narrow girdle view; (b) broad girdle view; (c) valve view. *Chaetoceros debilis*: (a) spiralled chain; (b) part of chain with resting spores. Partly after Cupp (1943). *Chaetoceros pseudocurvisetus*: partial chain. After Cupp (1943). Scale bars = 20  $\mu\text{m}$ .

Chaetoceros

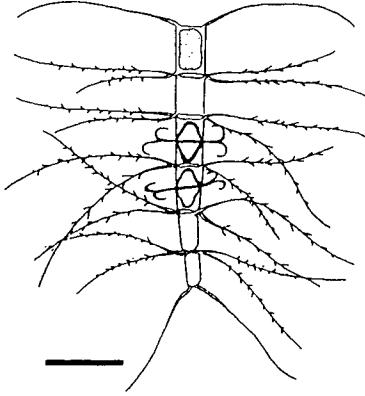

*C. radicans*

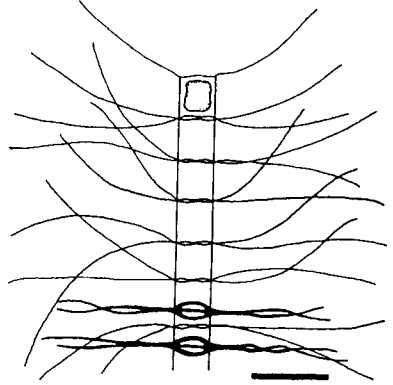

*C. furcellatus*

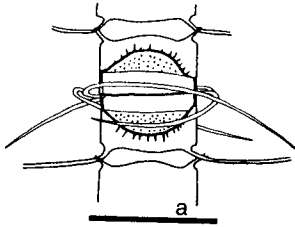

*C. cinctus*

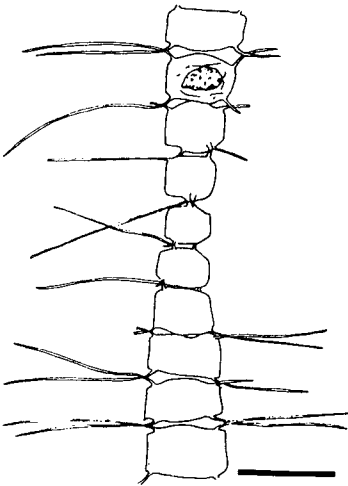
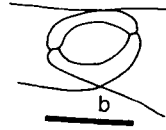

*C. tortissimus*

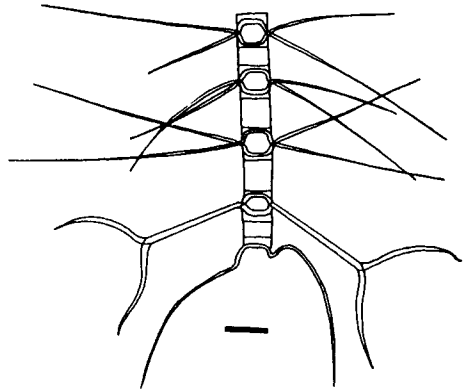

*C. messanensis*

TABLE 52 Morphometric Data of *Chaetoceros* spp. with One Chloroplast and Paired Resting Spores

Species	Apical axis ( $\mu\text{m}$ )
<i>C. cinctus</i>	5–15
<i>C. furcellatus</i>	8–20
<i>C. radicans</i>	6–25
<i>C. tortissimus</i>	11–20

*Chaetoceros tortissimus* Gran (Plate 45, Table 52)

**References:** Gran, 1900, p. 122, Plate 9, Fig. 25; Hustedt, 1930, p. 751, Fig. 434; Cupp, 1943, p. 142, Fig. 99; Hendey, 1964, p. 135, Plate 11, Fig. 2; Drebes, 1974, p. 82, Fig. 67.

Chains straight or slightly bent, very strongly twisted about chain axis.

Setae thin, arising somewhat inside the valve margin, perpendicular to chain axis but going in all directions. Apertures apparent only at corners; slightly convex valve surfaces of sibling cells touching in the middle.

Gross morphology similar to that of the three species previously described. Resting spores unknown.

**Distribution:**

*C. cinctus*, *C. radicans*, and *C. tortissimus*—cosmopolitan.

*C. furcellatus*—northern cold water region.

**Remarks:** *Chaetoceros furcellatus* and *C. cinctus* can hardly be distinguished without resting spores. The typical *C. radicans* is conspicuous by the spiny setae and the twisted chains, but Rines & Hargraves (1988) found forms with few or no spines on the setae. Also, the shape of the *C. radicans* chains and apertures varied during the season, and a similarity with *C. cinctus* and *C. tortissimus* was therefore striking. *Chaetoceros furcellatus* is one of the most common species of this genus in the Arctic.

---

PLATE 45 *Chaetoceros radicans*: slightly twisted chain with two resting spores. *Chaetoceros furcellatus*: chain with two resting spores. *Chaetoceros cinctus*: (a) partial chain with resting spore; (b) resting spore in valve view. After Cupp (1943). *Chaetoceros tortissimus*: twisted chain. After Cupp (1943). *Chaetoceros messanensis*: part of chain with characteristic intercalary setae. After Hustedt (1930). Scale bars = 20  $\mu\text{m}$ .

3c. Short rigid chains; two kinds of intercalary setae.

*Chaetoceros diversus* Cleve (Table 53)

**References:** Cleve, 1873a, p. 9, Plate 2, Fig. 12; Hustedt, 1930, p. 716, Fig. 409; Cupp, 1943, p. 132, Fig. 87; Hendey, 1964, p. 130, Plate 17, Fig. 4.

Chains straight and usually short. Setae arising from cell corners, no basal part. Apertures slit like. One type of intercalary setae thin, more or less curved, and usually turned toward chain ends; and the other type heavy, almost club shaped, first straight and at a sharp angle from chain axis, then turning and running almost parallel to chain axis in outer part.

Terminal setae thin and differ from the intercalary setae in position, being first U shaped, then nearly parallel to chain axis in outer part.

*Chaetoceros messanensis* Castracane (Plate 45, Table 53)

**References:** Castracane, 1875, p. 394, Plate 1, Fig. 1a; Hustedt, 1930, p. 718, Fig. 410; Cupp, 1943, p. 133, Fig. 89; Hendey, 1964, p. 129, Plate 12, Fig. 3; Evensen & Hasle, 1975, p. 162, Figs. 70–74.

Chains straight. Cells connected by drawn up poles of concave valves.

Apertures wide and linear six sided to almost round. Setae thin; no basal part. Terminal setae strongly diverging, unlike, and usually one directed backward from the chain. Some intercalary setae thicker than the others, first fused, then forked. Central process as in *C. curvisetus* (Evensen & Hasle, 1975, Figs. 71b).

**Distribution:** *C. diversus*, and *C. messanensis*—warm water region.

**Remarks:** *Chaetoceros laevis* Leuduger-Fortmorel is listed as a separate species in Cupp (1943). Hustedt (1930) suggested that *C. laevis* and *C. diversus* are conspecific.

3d. Valves of adjacent cells touch at valve poles.

*Chaetoceros affinis* Lauder (Plate 46, Table 54)

**References:** Lauder, 1864b, p. 78, Plate 8, Fig. 5; Hustedt, 1930, p. 695, Figs. 396–398; Cupp, 1943, p. 125, Fig. 78; Hendey, 1964, p. 127, Plate

TABLE 53 Morphometric Data of *Chaetoceros* spp. with One Chloroplast and Two Types of Intercalary Setae

Species	Apical axis ( $\mu\text{m}$ )
<i>C. diversus</i>	8–12
<i>C. messanensis</i>	9–40

*Chaetoceros*

PLATE 46 *Chaetoceros affinis*: chain with two resting spores. *Chaetoceros costatus*: chain with resting spores. After Cupp (1943). *Chaetoceros seiracanthus*: (a) chain in broad girdle view; (b) part of chain with two resting spores; (c) single resting spore. After Hustedt (1930). *Chaetoceros wighamii*: chain with typical orientation of setae. After Hustedt (1930). *Chaetoceros subtilis*: (a) chain; (b) resting spores. After Hustedt (1930). *Chaetoceros diadema*: (a) partial chain; (b) two cells with resting spores. After Cupp (1943). Scale bars = 20  $\mu\text{m}$ .

TABLE 54 Morphometric Data of *Chaetoceros* spp. with One Chloroplast and Straight Chains

Species	Apical axis ( $\mu\text{m}$ )
<i>C. affinis</i>	7–30
<i>C. costatus</i>	8–40
<i>C. diadema</i>	10–50
<i>C. holsaticus</i>	6–30
<i>C. karianus</i>	5–15
<i>C. seiracanthus</i>	12–24
<i>C. subtilis</i>	2–14
<i>C. wighamii</i>	7–18

18, Fig. 3; Drebes, 1974, p. 75, Fig. 58; Evensen & Hasle, 1975, p. 161, Figs. 46–54; Rines & Hargraves, 1988, p. 59, Figs. 113 and 114.

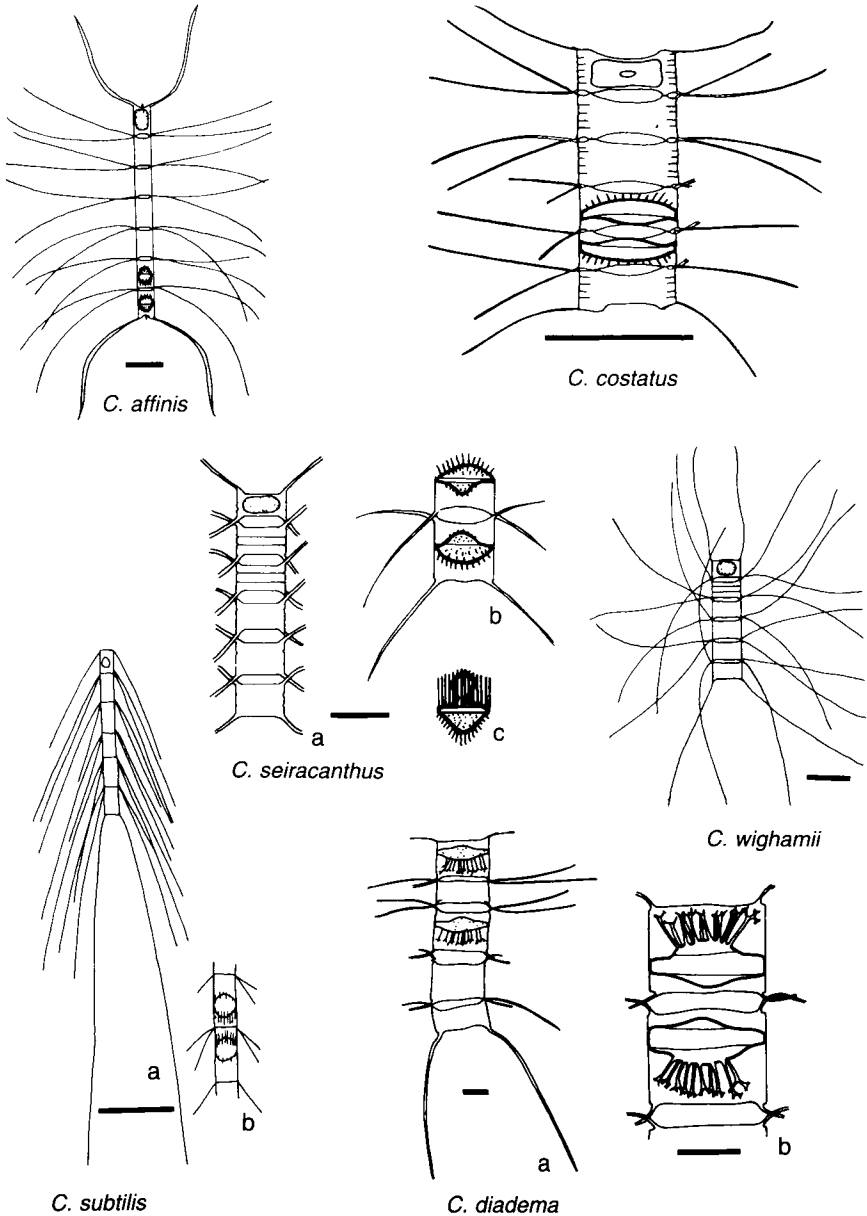
Chains straight. Poles of adjacent cells touch. Apertures narrow. Inner setae thin and without basal part. Terminal setae large, strongly divergent, and different from the inner setae. Resting spores with more or less vaulted valves; secondary valve often higher and bulging in the middle. Both valves with small spines; secondary valve with some longer and stouter spines.

**Remarks:** Lauder (1864b, p. 78) described the resting spores of *C. affinis* “with unequal, convex, hirsute valves,” whereas later descriptions reported a slight dissimilarity between the two valve surfaces (e.g., Hendey, 1964). *Chaetoceros willei* Gran has very narrow apertures, thin setae, and terminal setae “shorter, slightly thickened in the middle, diverging at an acute angle” (Gran, 1897b, p. 19). Resting spores were unknown at the time of the description of the species and have apparently never been reported. Hustedt (1930) regarded Gran’s species as a variety of *C. affinis* based on a certain variability of the shape of the terminal setae and the resting spore spines. Hendey (1964) retained *C. willei* as a separate species. Evensen & Hasle (1975) compared one culture from the Trondheimsfjord, Norway, probably identical to *C. affinis* var. *willei*, and a culture from California identified as *C. affinis*. Investigations (EM) showed certain differences regarding process and valve structure. The central process of both diatoms had a true labiate structure on the inside (Evensen & Hasle, 1975, Figs. 51 and 54). However, the external parts differed.

*Chaetoceros costatus* Pavillard (Plate 46, Table 54)

References: Pavillard, 1911, p. 24, Fig. 1b; Hustedt, 1930, p. 699, Fig. 399;

Cupp, 1943, p. 127, Fig. 79; Hendeby, 1964, p. 126, Plate 19, Fig. 3; Drebes, 1974, p. 77, Fig. 59; Rines & Hargraves, 1988, p. 69, Figs. 139 and 140.

Chains straight. Adjacent valves touch by two symmetrical valve protuberances at a short distance inside chain edge. Apertures small, elliptical, and shorter than apical axis. Setae thin and at nearly right angles to chain axis. Girdle bands conspicuous. Primary valve of resting spores evenly vaulted, with short spines; secondary valve smaller, centrally vaulted, and smooth.

***Chaetoceros karianus* Grunow (Table 54)**

**References:** Grunow, in Cleve & Grunow, 1880, p. 120, Plate 7, Fig. 135; Hustedt, 1930, p. 736, Fig. 424.

Chains straight and short. Poles of adjacent valves touch. Apertures narrowly lanceolate to elliptical. Setae thin and without basal part. Some of the inner setae perpendicular to chain axis, others curved around the chain. Inner part of terminal setae U shaped and outer part bent and outward divergent. Resting spores not known.

***Chaetoceros subtilis* Cleve (Plate 46, Table 54)**

**References:** Cleve, 1896b, p. 30, Fig. 8; Hustedt, 1930, p. 723, Fig. 413; Hendeby, 1964, p. 130, Plate 10, Fig. 2; Rines & Hargraves, 1988, p. 96, Figs. 204–206.

Chains short. Valves flat adjacent valves fitting tightly together. Apertures missing. Setae thin, arising at valve edge, straight, and all directed toward one end of chain. Resting spores with spines; the two valves unequally vaulted.

*Chaetoceros subtilis* var. *abnormis* Proschkina-Lavrenko is characterized by having only one terminal seta (Proschkina-Lavrenko, 1955 as *Chaetoceros abnormis*).

***Chaetoceros wighamii* Brightwell (Plate 46, Table 54)**

**References:** Brightwell, 1856, p. 108, Plate 7, Figs. 19–36; Hustedt, 1930, p. 724, Fig. 414; Cupp, 1943, p. 136, Fig. 91; Hendeby, 1964, p. 131, Plate 11, Fig. 3.

Chains delicate and straight. Poles of adjacent valves touch. Apertures narrowly lanceolate to lanceolate. Setae thin, arising from valve margin, without basal part. Inner setae running very irregularly being perpendicular, bowed, or parallel to chain axis. Terminal setae not thicker than the others, often nearly parallel to chain axis. Primary valve of resting spores rounded, with fine spines, secondary valve constricted at base and blunt cone shaped in the middle.



3e. Valves of adjacent cells do not touch at the valve poles.

***Chaetoceros diadema* (Ehrenberg) Gran (Plate 46, Table 54)**

**Basionym:** *Syndendrium diadema* Ehrenberg (= resting spore).

**Synonyms:** *Chaetoceros distans* var. *subsecunda* Grunow in Van Heurck, *Chaetoceros subsecundus* (Grunow) Hustedt.

**References:** Ehrenberg, 1854, Plate 35a, Fig. 18/13; Van Heurck, 1880–1885, Plate 82bis, Figs. 6 and 7; Gran, 1897b, p. 20, Plate 2, Figs. 16–18; Hustedt, 1930, p. 709, Fig. 404; Cupp, 1943, p. 130, Fig. 83; Hendeby, 1964, p. 128, Plate 10, Fig. 1; Drebes, 1974, p. 77, Fig. 60; Rines & Hargraves, 1988, p. 76, Figs. 150, 151, and 153.

Chains slightly twisted about central axis. Setae arising inside valve margin; basal part extending outward in valvar plane, crossing at chain edge, generally perpendicular to chain axis but running fairly irregularly. Terminal setae diverging at an acute angle. Apertures rather wide and elliptical with a slight central constriction. Primary valve of resting spore topped with 4–12 dichotomously branching spines; secondary valve centrally inflated and smooth.

***Chaetoceros holsaticus* Schütt (Table 54)**

**References:** Schütt, 1895, p. 40, Figs. 9a and 9b; Hustedt, 1930, p. 714, Fig. 407; Cupp, 1943, p. 131, Fig. 85; Hendeby, 1964, p. 128, Plate 15, Fig. 4.

Chains straight and sometimes slightly twisted. Setae thin, arising from inside valve margin, basal part running diagonally outward, crossing at chain edge; outer part of setae perpendicular to chain axis or bent toward chain ends. Terminal setae diverging at an acute angle. Apertures wide and hexagonal. Resting spores with small spines; primary valve larger than secondary valve.

***Chaetoceros seiracanthus* Gran (Plate 46, Table 54)**

**References:** Gran, 1897b, p. 21, Plate 3, Figs. 39–41; Hustedt, 1930, p. 711, Fig. 405; Cupp, 1943, p. 131, Fig. 84; Hendeby, 1964, p. 129, Plate 15, Fig. 1; Rines & Hargraves, 1988, p. 92, Fig. 199.

Setae thin. Otherwise as described for *C. diadema*. Primary valve of resting spores smoothly vaulted and covered with small spines, secondary valve rounded to capitate, also covered by spines.

**Distribution:**

*C. affinis* and *C. diadema*—cosmopolitan.

*C. costatus* and *C. seiracanthus*—warm water region to temperate.

*C. karianus*—northern cold water region.

*C. holsaticus*—cold water (Cupp, 1943), common in brackish water.

*C. subtilis* and *C. wighamii*—probably restricted to brackish water.

3f. Chains curved and in irregular, spherical colonies.

***Chaetoceros socialis* Lauder (Plate 47)**

**References:** Lauder, 1864b, p. 77, Plate 8, Fig. 1; Hustedt, 1930, p. 751, Fig. 435; Cupp, 1943, p. 143, Fig. 100; Hendey, 1964, p. 136, Plate 15, Fig. 3; Drebes, 1974, p. 82, Fig. 68; Evensen & Hasle, 1975, p. 160, Figs. 33–39; Rines & Hargraves, 1988, p. 95, Fig. 207; Takano, 1990, pp. 292–293.

Chains short. Poles of adjacent valves not touching one another. Three setae of two adjacent valves short, the fourth one straight, elongated, and serving in formation of the more or less spherical secondary colonies by being entwined in the colony center with the elongated setae of other chains. Resting spores, both valves rounded and smooth. The central process is similar to that of *C. curvisetus* (Hasle & Evensen, 1975, EM).

**Morphometric data:** Apical axis, 2–14  $\mu\text{m}$ .

**Distribution:** Probably cosmopolitan, very important in plankton close to the ice in the northern cold water region and, according to Cupp (1943), also one of the most prominent species in the Gulf of California.

**Remarks:** *Chaetoceros radians* Schütt, also appearing in spherical colony, has usually been regarded as a separate species distinguished from *C. socialis* by spiny resting spores (Plate 47) but was reduced in rank to a variety of *C. socialis* by Proschkina-Lavrenko (1953).

3g. Unicellular species.

Rines & Hargraves (1988) mention seven unicellular *Chaetoceros* species commonly reported in the literature, one of them has now been transferred to *Attheya* and is discussed here. Of the other six Rines & Hargraves regarded *C. ceratosporus* Ostefeld, *C. muelleri* Lemmermann (inland waters), *C. simplex* Ostefeld, and *C. tenuissimus* Meunier as adequately described species possible to recognize. According to the same authors “names such as *C. gracilis* Schütt and *C. calcitrans* have most likely been applied to many different, not necessarily related forms which happen to have a similar appearance” (Rines & Hargraves, 1988, p. 99).

***Chaetoceros ceratosporus* Ostefeld (Plate 47, Table 55)**

**References:** Ostefeld, 1910, p. 278; Hustedt, 1930, p. 760, Fig. 442; Hendey, 1964, p. 138, Plate 17, Fig. 7; Rines & Hargraves, 1986, p. 104, Figs. 1, 2, 22, and 23.

Cells most commonly single or in pairs. Valves drawn up at the poles, each valve with one central process, usually visible with LM. Setae, thin, originate at poles of apical axis and bend sharply outward. Primary valve

*Chaetoceros*

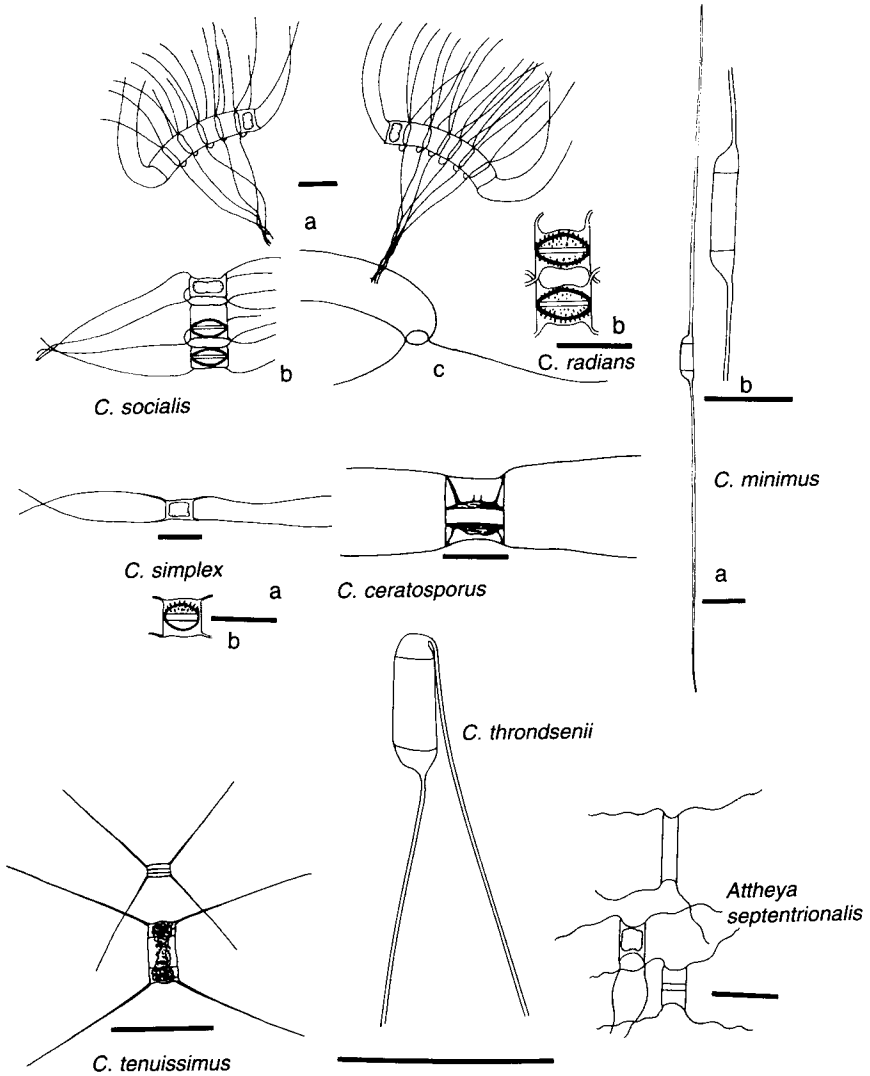

PLATE 47 *Chaetoceros socialis* and *Chaetoceros radians*: (a) chains and secondary colonies; (b) cells with resting spores; (c) cell in valve view. *Chaetoceros simplex*: (a) cell with chloroplast; (b) cell with resting spore. *Chaetoceros ceratosporus*: Cell with resting spore. After Hustedt (1930). *Chaetoceros minimus*: (a) whole cell; (b) detail. After Hustedt (1930). *Chaetoceros tenuissimus*: two cells. After Hustedt (1930). *Chaetoceros thronsenii*: part of cell with characteristic setae. After Marino et al. (1987). *Attheya septentrionalis*: three cells with characteristic setae. Scale bars = 20  $\mu\text{m}$ .

TABLE 55 Morphometric Data of Unicellular *Chaetoceros* spp.—Solitary Cells

Species	Apical axis ( $\mu\text{m}$ )
<i>C. ceratosporus</i>	4–20
<i>C. simplex</i>	4–30
<i>C. tenuissimus</i>	3–5

of resting spores more or less evenly vaulted with two large processes originating near valve edge, growing toward or into setae of vegetative valve, valve center covered with numerous small spines; secondary valve evenly vaulted to bluntly truncated, occasionally with processes and spines.

*Chaetoceros ceratosporus* var. *brachysetus* Rines & Hargraves

Reference: Rines & Hargraves, 1986, p. 105, Figs. 7–21 and 24–26; Rines & Hargraves, 1988, p. 63, Figs. 123–127.

Setae thicker and shorter than in the nominate variety and constricted at the base.

*Chaetoceros simplex* Ostenfeld (Plate 47, Table 55)

References: Ostenfeld, 1901b, p. 137, Fig. 8; Hustedt, 1930, p. 755, Fig. 437; Hendey, 1964, p. 137, Plate 19, Fig. 2.

Setae thin, long, straight and lying in the direction of apical axis of the cell. Resting spores with vaulted valves with spines.

*Chaetoceros tenuissimus* Meunier (Plate 47, Table 55)

Synonym: *Chaetoceros simplex* var. *calcitrans* Paulsen.

References: Paulsen, 1905, p. 6; Meunier, 1913, p. 49, Plate 7, Fig. 55; Hustedt, 1930, p. 756, Fig. 438; Rines & Hargraves, 1988, p. 97.

Cells extremely small with apical and perivalvar axes approximately equal. Setae straight, sometimes scarcely longer than apical axis, emerging from poles of valve at a 45° angle to both apical and perivalvar axes. Resting spores unknown. Probably one chloroplast. See Rines & Hargraves (1988, p. 97) for discussion about *C. galvestonensis* Collier & Murphy and *C. calcitrans* f. *pumilus* Takano as synonyms of *C. tenuissimus*.

Remarks: In light of the evident identification problems the distribution of these species can scarcely be given. They seem to occur mainly in brackish and other inshore waters.

4. Two, seldom three, setae per cell.

*Chaetoceros minimus* (Levander) Marino, Giuffr , Montresor, & Zingone, 1991 (Plate 47, Table 56)

**Basionym:** *Rhizosolenia minima* Levander.

**Synonym:** *Monoceros isthmiiiformis* Van Goor.

**References:** Levander, 1904, p. 115, Figs. 7 and 8; Van Goor, 1924, p. 303, Fig. 3; Hustedt, 1930, p. 598, Fig. 343; Marino et al., 1991, p. 318, Figs. 1–9.

Cells isovalvate. One seta per valve; the two setae running in opposite directions. Resting spores ellipsoidal; primary valve with scattered protuberances, knobs, and sometimes spines; secondary valve with regularly arranged numerous small knobs, a strong stud-like central protuberance, a wide flange, and a marginal collar.

*Chaetoceros thronsdensei* (Marino, Montresor, & Zingone) Marino, Montresor, & Zingone var. *thronsdensei* (Plate 47, Table 56)

**Basionym:** *Miraltia thronsdensei* Marino, Montresor, & Zingone.

**References:** Marino et al., 1987; Marino et al., 1991.

Cells heterovalvate. One seta per valve; the two setae of a cell running in same direction. Primary valve of resting spores strongly convex with numerous small protuberances; secondary valve more flattened, with one or two central stud like protuberances, a wide flange and a marginal collar.

*Chaetoceros thronsdensei* var. *trisetosus* Zingone (in Marino et al., 1991)

**Reference:** Marino et al., 1991, p. 319

Differs from the nominate variety by having a third seta.

#### Distribution:

*C. minimus*—brackish water: northern part of the Baltic Sea, Dutch inshore waters, Tyrrhenian brackish water lagoons.

*C. thronsdensei*—Gulf of Naples.

**Remarks:** The small size and the weak silicification make the species difficult to recognize. Both species may appear in cell concentrations amounting to millions per liter (Marino et al., 1987). Whereas *C. minimus* is a typical

TABLE 56 Morphometric Data of *Chaetoceros* spp. with Two or Three Setae per Cell

Species	Pervalvar axis ( $\mu\text{m}$ )	Apical axis ( $\mu\text{m}$ )	Length of setae ( $\mu\text{m}$ )
<i>C. minimus</i>	6–32	2–7	10–220
<i>C. thronsdensei</i>	8–15	1.5–5	30–40; 10–40

brackish water species, *C. thronsdensei* made up 45% of the diatom population at salinity of 35.9‰.

**Genus *Attheya*** T. West

**Type:** *Attheya decora* T. West.

**References:** West, 1860, p. 152, Plate 7, Fig. 15; Hustedt, 1930, p. 768, Fig. 449; Crawford et al., 1994.

*Attheya* is distinguished morphologically from *Chaetoceros* by structure of valve outgrowths or horns and by type of girdle bands as revealed with EM (Crawford et al., 1994). The frequent appearance of resting spores in *Chaetoceros* but not in *Attheya*, the planktonic habitat of *Chaetoceros*, and *Attheya* being attached to sand grains and other diatoms are other distinctive features.

***Attheya septentrionalis*** (Østrup) Crawford (Plate 47)

**Basionym:** *Chaetoceros septentrionalis* Østrup.

**Synonym:** *Gonioceros septentrionalis* (Østrup) Round, Crawford, & Mann.

**References:** Østrup, 1895, p. 457, Plate 7, Fig. 88; Hustedt, 1930, p. 759, Fig. 441; Hendey, 1964, p. 137, Plate 14, Fig. 5; Duke et al., 1973; Evensen & Hasle, 1975, p. 164, Figs 79–82; Round et al., 1990, pp. 334 and 340; Crawford et al., 1994, p. 41, Figs. 42–49.

Solitary or in pairs. Horns fairly long [three times cell length (Crawford et al., 1994, Table 2)], arising at the poles of the valves and projecting parallel to the valvar plane. Tips of the horns open and thickened.

Chloroplasts one or two per cell.

**Morphometric data:** Apical axis, 4–6  $\mu\text{m}$ .

**Distribution:** Northern cold water region to temperate(?).

**Remarks:** *Attheya longicornis* Crawford & Gardner (Crawford et al., 1994, p. 38) has long (8–10 times cell length) and not markedly flexuous horns. It has most likely been identified as *Chaetoceros septentrionalis* in the past, and it may well be that specimens recorded as *C. septentrionalis* in temperate waters belong to *A. longicornis*.

**How to identify:** *Bacteriastrum* spp., *Chaetoceros* spp., as well as *A. septentrionalis* and *A. longicornis* may be identified in water mounts. Phase contrast is recommended for the identification of the more delicately structured, weakly silicified species especially for recognizing the setae.

**Family Lithodesmiaceae** H. & M. Peragallo 1897–1908 emend. Simonsen 1979

The circumscription of this family varies from including *Bellerochaeta*, *Ditylum*, and *Lithodesmium* (H. & M. Peragallo, 1897–1908; Glezer et al., 1988) to including, in addition, *Streptothecha* and *Neostreptothecha* (Simonsen, 1979; Ricard, 1987) and, finally *Lithodesmioides* (von Stosch, 1987).

Lithodesmiaceae Round within the order Lithodesmiales Round & Crawford and subclass Lithodesmiophycidae Round & Crawford [all taxa described in Round et al. (1990)] includes *Lithodesmium*, *Lithodesmioides*, and *Ditylum*. Here, we follow von Stosch (1987) using the widest circumscription of the family.

We have taken into consideration the new name *Helicotheca* Ricard for the diatom genus described by Shrubsole (1890) as *Streptotheca*, the fungal genus *Streptotheca*, Vuillemin being described in 1887 (Farr et al., 1979, p. 1692). The diatom genus *Streptotheca* was designated as the type of the new family Streptothecaceae Crawford (Round et al., 1990). Possible consequences regarding the name of the family should be taken into account by those using the classification by these authors.

Terminology specific to Lithodesmiaceae (after von Stosch, 1977, 1980, 1986, 1987):

**Ansula**—single element of the fringed marginal ridge of *Ditylum*, shaped as a ribbon longitudinally split in its medium part.

**Bilabiate process**—a process consisting of an external shorter or longer tube, sometimes reduced to a low ring (LM), and an internal part with a longer or shorter stalk and a trapezoid end piece closed at the tip but open at each of the two slanting sides by a longitudinal slit (EM, Fig. 8).

**Fissipariety**—split wall character, i.e., a localized *in vivo* separation of the siliceous and diatotopic layers of the cell wall, the diatotopic layer being the acidic layer rich in carbohydrates between the siliceous layer and the plasmalemma.

The two slits of the bilabiate process can hardly be seen with LM; however, the trapezoid shape of the internal part of a process in side view is discernible, e.g., in *Helicotheca*. The term bilabiate process was first introduced for *Bellerochea* and *Helicotheca* (von Stosch, 1977, p. 125). Von Stosch evidently considered fissipariety as an important descriptive character. We are not convinced of its usefulness for identification purposes, especially when dealing with preserved material, and it has therefore not been used here.

Family characters:

Cells solitary or in separable or inseparable ribbons.

Cells in girdle view rectangular, square, or shaped as a parallelogram.

Girdle consisting of several rows (columns) of bands (segments).

Valve outline biangular, triangular, quadrangular or quinqueangular.

Each valve with one bilabiate process.

Resting spores known in one genus.

## KEY TO GENERA

- 1a. Marginal ridge present . . . . . 2  
 1b. Marginal ridge absent, intercellular spaces missing . . . . . 3  
 2a. Cells in inseparable or separable ribbons, seldom solitary . . . . . 4  
 2b. Cells solitary . . . . . 5  
 3a. Cells rectangular in broad girdle view . . . . . *Helicotheca*, p. 234  
 3b. Cells like a parallelogram in broad girdle view . *Neostreptothecha*, p. 235  
 4a. Ribbons with conspicuous intercellular spaces . . . . *Bellerochea*, p. 227  
 4b. Cells in ribbons joined by a slight overlap of a conspicuous marginal ridge  
 . . . . . *Lithodesmium*, p. 232  
 5a. Marginal ridge conspicuous, often fringed, no defined elevations at valve  
 corners . . . . . *Ditylum*, p. 230  
 5b. Marginal ridge inconspicuous, well defined elevations at valve corners. .  
 . . . . . *Lithodesmioides*, p. 231

Genus *Bellerochea* Van Heurck 1885 emend. von Stosch 1977 (Plate 48, Table 57)

Type: *Bellerochea malleus* (Brightwell) Van Heurck.

Basionym: *Triceratium malleus* Brightwell.

References: Brightwell, 1858b, p. 155, Plate 8, Figs. 6 and 7; Van Heurck, 1880–1885, p. 203, Plate 114, Fig. 1; Hustedt, 1930, p. 781, Fig. 456; Hendeby, 1964, p. 122, Plate 6, Fig. 5; Drebes, 1974, p. 95, Figs. 80a and 80b; Hasle, 1975, Figs. 152–154; von Stosch, 1977, p. 128, Text Fig. 1, Figs. 1–70; von Stosch, 1987, p. 74, Figs. 204–208; Takano, 1990, pp. 294–295.

Generic characters:

Cells in ribbons.

Cells very weakly silicified.

Cells in broad girdle view roughly rectangular.

Cells in valve view biangular to quadrangular, rarely three or four armed.

Short elevation at each corner of the valve; those of adjacent cells in ribbons abutting.

Valves consisting of tracery of siliceous costae covering valve mantle, marginal ridge and most of valve face.

Bilabiate process with long external tube.

Chloroplasts numerous, oval and slightly constricted.

Characters showing differences between species:

Type of ribbons (separable or inseparable).

Shape of intercellular spaces.

Location of bilabiate process.



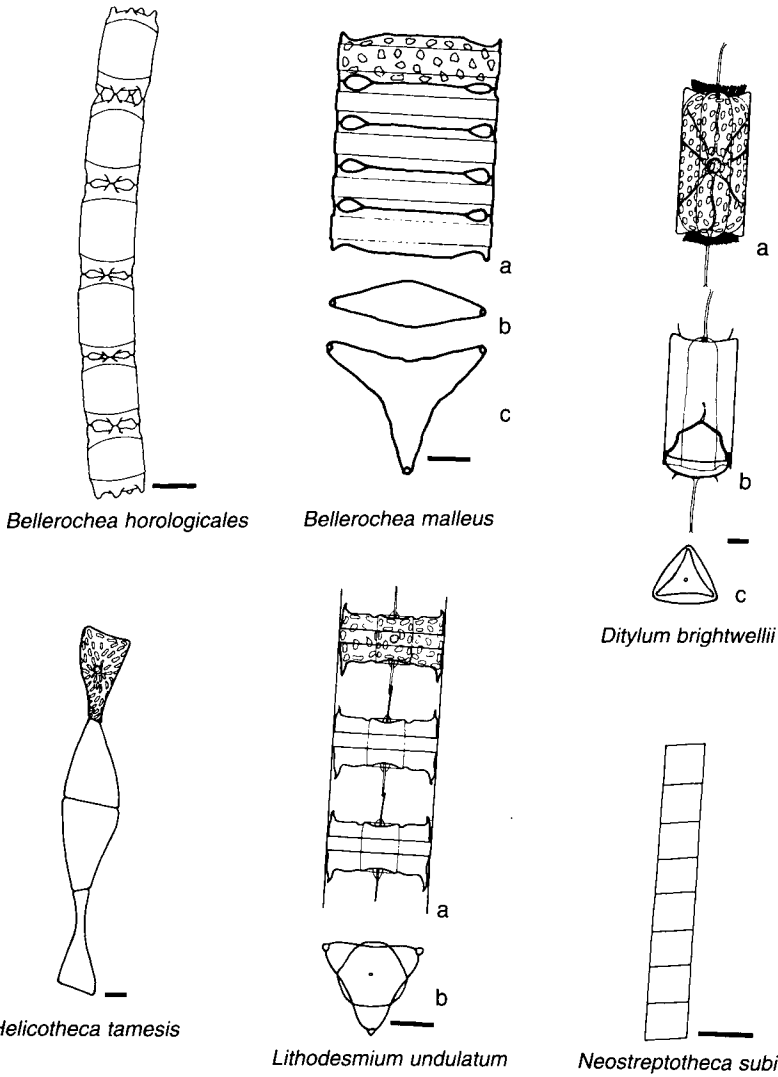

**PLATE 48** *Bellerochea horologicales*: chain, short valve elevations and intercellular spaces. *Bellerochea malleus*: (a) short chain; (b and c) two types of valves. *Ditylum brightwellii*: (a) single cell with outer parts of bilabiate process; (b) cell with resting spore; (c) valve view. *Helicotheca tamesis*: twisted chain. *Lithodesmium undulatum*: (a) short chain; (b) valve with central bilabiate process and depressions across the corners. *Neostreptothecha subindica*: chain in girdle view. Scale bars = 20  $\mu$ m.

TABLE 57 Morphometric Data of *Bellerochea* spp.

Species	Pervalvar axis ( $\mu\text{m}$ )	Apical axis ( $\mu\text{m}$ )	Transapical axis ( $\mu\text{m}$ )	Mantle costae in 10 $\mu\text{m}$
<i>B. horologicalis</i>	40–54	28–98	25–32	23–27
<i>B. malleus</i> <sup>a</sup>	13–34	22–210	20–27	10–22
<i>B. yucatanensis</i>	34–70	16–33	15.5–21	ca. 33 (EM)

<sup>a</sup> Side length of triangular cells: 52–180  $\mu\text{m}$ .

### KEY TO SPECIES

- 1a. Ribbons inseparable, cells tightly joined, bilabiate process marginal
- 1b. Ribbons separable, cells loosely joined, bilabiate process central . . . . .  
 . . . . . *B. yucatanensis* von Stosch
- 2a. Ribbons usually straight, cells biangular, triangular, or quadrangular, intercellular spaces drop shaped, open only near elevations, costae interrupted in valve center . . . . .  
 . . . . . *B. malleus* (Brightwell) Van Heurck emend. von Stosch
- 2b. Ribbons curved in transapical plane, or straight or nearly straight, cells biangular (quadrangular?), intercellular spaces dumbbell shaped, costae partly continuous . . . . . *B. horologicalis* von Stosch

### Distribution:

*B. horologicalis*—known from Florida (Gulf of Mexico) and Melville Bay, Australia.

*B. malleus*—known with certainty only from the North Sea, the English Channel, the French and Portuguese Atlantic coasts, Portuguese Guinea, and Leigh, New Zealand.

*B. yucatanensis*—known from Australia and the type locality, Porto Progreso, Yucatan.

**How to identify:** The species are distinguished mainly by the shape of the ribbons and may thus be identified in water mounts. Details of valve structure may be recognized by phase contrast examination of material cleaned of organic matter as air mounts (von Stosch, 1977, 1987) or mounted in a medium of a high refractive index.

**Remarks:** The information on distribution is from von Stosch (1977, 1987), who emphasized that all three species might have been identified as *B. malleus* in the past. *Bellerochea yucatanensis* is characterized by the loosely connected cells in ribbons implying that only single valves will be present in cleaned material. The two other species occur mostly as pairs connected by the filaments of the marginal ridges (except for terminal valves). In valve view *B. malleus* differs from *B. horologicalis* by the median part of the valve being

without costae and by an unevenly ribbed marginal ridge. Von Stosch (1986) described *B. horologicalis* var. *recta* from Townsville, north Queensland, Australia, as distinguishable from the nominate variety by having straight or nearly straight chains.

**Genus *Ditylum*** J. W. Bailey ex L. W. Bailey 1861 (Plate 48, Table 58)  
**Lectotype:** *Ditylum trigonum* J. W. Bailey ex L. W. Bailey (*vide* Round et al., 1990, pp. 292 and 689).

**Correct name:** *Ditylum brightwellii* (West) Grunow (*vide* Van Heurck, 1880–1885, plate 114).

**References:** West, 1860, p. 149, Plate 7, Figs. 6a and 6b; Bailey, 1861, p. 332, Plate 7; Van Heurck, 1880–1885, Plate 114, Figs. 3–9, Plate 115, Figs. 1 and 2; Schröder, 1906, p. 355, Fig. 24; Hustedt, 1930, p. 784, Figs. 457–460; Cupp, 1943, p. 148, Fig. 107; Hendey, 1964, p. 111, Plate 5, Fig. 1; Drebes, 1974, p. 59, Fig. 44; Hasle, 1975, Figs. 144–148; Hargraves, 1982; von Stosch, 1987, p. 57, Figs. 112–203; Takano, 1990, pp. 296–297; Delgado & Fortuño, 1991, Plate 60, Figs. b, c, and d.

Generic characters:

Cells solitary.

Cells in girdle view rectangular.

Cells in valve view usually triangular.

Marginal ridge fimbriate (with ansulae) or slotted (a basal membrane with entire margin but perforated by evenly spaced pervalvar slots).

Valve structure consisting of radially arranged poroid areolae and/or ribs starting from a nonperforated area around a central bilabiate process.

External part of process long.

Chloroplasts numerous small granules.

TABLE 58 Morphometric Data of *Ditylum* spp.

Species	Pervalvar axis ( $\mu\text{m}$ )	Diameter ( $\mu\text{m}$ )	Valve areolae or ribs in 10 $\mu\text{m}$	Mantle areolae in 10 $\mu\text{m}$
<i>D. brightwellii</i>	80–130	25–100	10	18
<i>D. buchananii</i>	52–112	73–139 <sup>a</sup>	14–15	23–24
<i>D. pernodii</i>	— <sup>b</sup>	—	27–28	ca. 36
<i>D. sol</i>	—	40–225	19–20	—

<sup>a</sup> Side length.

<sup>b</sup>—, No data.

Characters showing differences between species:

Shape and structure of marginal ridge.

Valve structure: areolae, interareolar costae, discernible or not discernible with LM.

### KEY TO SPECIES

- 1a. Areolae around valve central area elongated . . . . . 2  
 1b. Areolae around valve central area not elongated. . . . . 3  
 2a. Areolae on valve face conspicuously larger than those on valve mantle, marginal ridge entire and slotted, or fimbriate with ansulae. . . . .  
 . . . . . *D. brightwellii*<sup>13</sup> (West) Grunow in Van Heurck  
 2b. Areolae close to central area especially large, the rest on valve face like those on valve mantle, the presence of ansulae variable . . . . .  
 . . . . . *D. sol*<sup>13</sup> Grunow in Van Heurck  
 3a. Ansulae restricted to apical fourth of marginal ridge. . . . .  
 . . . . . *D. buchananii* von Stosch  
 3b. Ansulae along whole marginal ridge. . . . . *D. pernodii* Schröder

#### Distribution:

*D. brightwellii*—cosmopolitan although not recorded from polar regions.

*D. buchananii*—Gulf of Carpentaria, Australia, Gulf of Thailand (von Stosch, 1987).

*D. pernodii*—Papua, New Guinea, Gulf of Carpentaria, Townsville and Melville Bay, Australia (von Stosch, 1987).

*D. sol*—warm water region.

**How to identify:** The species may be discriminated by combined phase contrast examinations of whole frustules, preferably in a medium of a high refractive index (e.g., Pleurax) and of single valves cleaned of organic matter and mounted in a medium of a high refractive index.

**Remarks:** *Ditylum brightwellii* and *D. buchananii* form resting spores (Hargraves, 1982; von Stosch, 1987). *Ditylum buchananii* and *D. pernodii* both have a very delicate ornamentation of the valve face. The triangular marginal ridge of *D. buchananii* has rounded corners, whereas the marginal ridges of *D. pernodii* and *D. sol* have subacute and narrow corners.

**Genus** *Lithodesmioides* von Stosch 1987 (Table 59)

**Type:** *Lithodesmioides polymorpha* von Stosch.

**Reference:** von Stosch, 1987, p. 46, Figs. 60–111.

<sup>13</sup> Basionyms: *Triceratium brightwellii* T. West and *Triceratium sol* Grunow in Van Heurck, respectively.

TABLE 59 Morphometric Data of *Lithodesmioides* spp.

Species	Pervalvar axis ( $\mu\text{m}$ )	Width ( $\mu\text{m}$ )	Valve areolae in 10 $\mu\text{m}$	Length of external processes in $\mu\text{m}$
<i>L. minuta</i>	14–28	17–25	21–26	ca. 3
<i>L. polymorpha</i>	27–65	33–66	18	ca. 3

## Generic characters:

Cells solitary.

Cells in valve view regularly quadrangular and in one species alternatively irregularly triangular to quinqueangular.

Central bilabiate process with short external tube.

Poroid areolae in radial rows from nonperforated central area.

Circular concavity in middle of valve face.

No depressions between valve corners and central area.

## Characters showing differences between species:

Cell size.

Valve outline.

Size of central depression.

## KEY TO SPECIES

- 1a. Valves regularly quadrangular, valve face smooth . . . . .  
 . . . . . *L. minuta* von Stosch
- 1b. Valves regularly quadrangular, or irregularly triangular, quadrangular, or quinqueangular, spines around valve center . . . . .  
 . . . . . *L. polymorpha* von Stosch

## Distribution

*L. minuta*—Townsville, north Queensland, Australia.

*L. polymorpha*—mouth of Norman River, Australia, probably benthic.

**How to identify:** Examination in phase contrast or interference contrast of whole frustules mounted in Pleurax is evidently the superior method for identification (von Stosch, 1986, 1987).

**Genus *Lithodesmium*** Ehrenberg 1839 (Plate 48, Table 60)

**Type:** *Lithodesmium undulatum* Ehrenberg.

**References:** Ehrenberg, 1841a, p. 127, Plate 4, Figs. 13a–13c; West, 1860, p. 148, Plate 7, Fig. 5; H. & M. Peragallo, 1897–1908, p. 394, Plate 96, Figs. 4 and

TABLE 60 Morphometric Data of *Lithodesmium* spp.

Species	Pervalvar axis ( $\mu\text{m}$ )	Side length ( $\mu\text{m}$ )	Valve areolae in 10 $\mu\text{m}$	Length of external processes in $\mu\text{m}$
<i>L. duckerae</i>	17–43	22–61	9–10	18
<i>L. intricatum</i>	Up to 55	34–63	21–24	8
<i>L. undulatum</i>	Up to 74	37–93	12–13	— <sup>b</sup>
<i>L. variabile</i>	<Width	25–65 <sup>a</sup>	30 (SEM)	3.5–4.5

<sup>a</sup> Width (Takano, 1979).

<sup>b</sup>—, No data.

5; Hustedt, 1930, p. 789, Fig. 461; Cupp, 1943, p. 150, Fig. 108; Hendeby, 1964, p. 111, Plate 6, Fig. 6; Hasle, 1975, Figs. 149–151; Takano, 1979; von Stosch, 1980; von Stosch, 1987, p. 42, Figs. 46–59; Takano, 1990, pp. 298–299.

#### Generic characters:

Cells solitary or in ribbons.

Cells in girdle view rectangular to square.

Cells in valve view triangular, rarely biangular or quadrangular.

Marginal ridge membranous.

Each valve with a central bilabiate process with long external tube.

Valve face with radial rows of poroid areolae starting from a nonperforated area around the process.

Conspicuous elevations at valve corners.

Proximal to each elevation a depression in valve face across the corners.

Chloroplasts, numerous small bodies.

#### Characters showing differences between species:

Solitary or in ribbons.

Direction of marginal ridge in relation to valve mantle.

Structure of marginal ridge.

Shape of valve mantle.

Height of elevations.

Size of valve areolae.

#### KEY TO SPECIES

- 1a. Cells solitary or in ribbons. . . . . 2  
 1b. Cells solitary . . . . . *L. duckerae* von Stosch  
 2a. Marginal ridge only partly perforated. . . . . 3

- 2b. Marginal ridge with clear pattern of perforation . . . . . *L. undulatum* Ehrenberg
- 3a. Valves triangular, perforation of marginal ridge without a clear pattern and restricted to its advalvar half . . . . . *L. intricatum*<sup>14</sup> (T. West) H. & M. Peragallo
- 3b. Valves more or less irregularly biangular, triangular, or quadrangular, marginal ridge sparsely or not perforated . . . . . *L. variabile* Takano

**Distribution:**

*L. duckerae*—warm water region, probably benthic (von Stosch, 1987).

*L. intricatum* and *L. undulatum*—warm water region to temperate.

*L. variabile*—recorded in the literature only from Japanese coastal waters, but probably also present in Gulf of Naples (G. Hasle, personal observations).

**How to identify:** As for the other genera of this family a combination of girdle and valve view examinations may be needed. The distinction between *L. undulatum* and *L. intricatum* manifest in the perforation of the marginal ridge may be seen in water mounts but more clearly in a medium of a high refractive index.

**Remarks:** *Lithodesmium undulatum* and *L. intricatum* differ in the shape of the valve mantle and the marginal ridge. The valve mantle of *L. intricatum* has a widening in its transition to the girdle and the marginal ridge is inclined outwards or inwards. The valve mantle of *L. undulatum* is at a right angle to the valvar plane, and the marginal ridge is in the same plane as the mantle and the girdle. The sides of *L. undulatum* valves are undulated, whereas those of *L. intricatum* are straight or slightly concave. *Lithodesmium duckerae* is similar to *L. intricatum* but has higher elevations; the depressions across the corners are on an average deeper, the valve face areolation is much coarser, and there are siliceous spines in the valve center. The taxonomic position of *L. variabile* is dubious. Von Stosch (1987) suggested a similarity to *Lithodesmioides* based on the presence of a nonperforated and low marginal ridge. It has, however, depressions across the valve corners, and our own observations indicate the presence of some perforation of the marginal ridge, and, as also concluded by von Stosch (1987), its correct position therefore seems to be in *Lithodesmium*.

**Genus *Helicotheca*** Ricard 1987

**Synonym:** *Streptothecha* Shrubsole 1890.

**Type:** *Helicotheca tamesis* (Shrubsole) Ricard; see Ricard (1987, p.75).  
Monospecific genus.

***Helicotheca tamesis*** (Shrubsole) Ricard (Plate 48)

**Basionym:** *Streptothecha tamesis* Shrubsole.

<sup>14</sup> Basionym: *Triceratium intricatum* T. West.

**References:** Shrubsole, 1890; Hustedt, 1930, p. 778, Fig. 455; Cupp, 1943, p. 147, Fig. 106; Hendeby, 1964, p. 113, Plate 7, Fig. 2; Drebes, 1974, p. 98, Fig. 80c; Hasle, 1975, p. 126, Figs. 131–141; von Stosch, 1977, p. 134, Figs. 78–84.

**Girdle view:** Chains ribbon shaped and separable. Chains and cells with a torsion in relation to pervalvar axis. Cells in broad girdle view rectangular apart from the torsion. Chloroplasts numerous and broadly oval with a slight constriction, each with a pyrenoid.

**Valve view:** Valves linear oblong and slightly inflated in the middle. Each valve with a subcentral bilabiate process, the external part a low ring, and the internal part with a long stalk. Valve structure not resolvable with LM.

**Morphometric data:** Pervalvar axis, 56–120  $\mu\text{m}$ , apical axis, 26–160  $\mu\text{m}$ ; transapical axis, 9–11  $\mu\text{m}$ .

**Distribution:** Warm water region to temperate.

**How to identify:** The species may be identified in chains in water mounts and as single cleaned valves mounted in a medium of a high refractive index by the valve outline and shape and position of the process.

**Genus *Neostreptotheca*** von Stosch 1977 emend. von Stosch 1987 (Plate 48, Table 61)

**Type:** *Neostreptotheca subindica* von Stosch.

**References:** von Stosch, 1977, p. 134, Figs. 85–94; von Stosch, 1987, p. 78, Figs. 209–234.

Generic characters:

Cells in straight separable ribbons.

Intercellular spaces missing.

Cells in broad girdle view shaped like a parallelogram.

Cells in valve view linear oblong and slightly inflated at the apices and in the middle.

TABLE 61 Morphometric Data of *Neostreptotheca* spp.

Specie	Pervalvar axis ( $\mu\text{m}$ )	Apical axis ( $\mu\text{m}$ )	Transapical axis ( $\mu\text{m}$ )
<i>N. subindica</i>	72–157	70–138	8–12
<i>N. torta</i>	—	28–77 (104)	—

*Note:* —, No data; number in parentheses occasionally found.



Each valve with a marginal bilabiate process, the external part a low ring, and the internal part with a long stalk.

Valve structure not resolvable with LM.

Chloroplasts numerous and rounded.

**KEY TO SPECIES (von Stosch, 1987, p. 82)**

- 1a. Ribbons (or solitary), flat, valves oblique to girdle in broad girdle view . . . . . *N. subindica* von Stosch  
 1b. Chains (or solitary) twisted or spiraled, valves oblique or sometimes perpendicular to girdle in broad girdle view. . . . . *N. torta* von Stosch

**Distribution:** Warm water region.

**Remarks:** Von Stosch (1987) described *Neostreptothecca torta* with the form *triangularis* from Australian plankton. *Neostreptothecca torta* f. *torta* sometimes has rectangular cells and is thus habitually similar to *Helicothecca* from which it differs by a special structure around the base of the process which is revealed with TEM.

**Family Eupodiscaceae Kützing 1849**

*Odontella* is the only genus included in Eupodiscaceae *sensu* Simonsen, 1979 that has typically marine planktonic species. Round et al. (1990) placed *Odontella* in Triceratiaceae (Schütt) Lemmermann, order Triceratiales Round & Crawford, subclass Biddulphiophycidae Round & Crawford, and Glezer et al. (1988) placed *Odontella* in Biddulphiaceae Kützing, order Biddulphiales.

The species listed in this chapter as *Odontella* spp. were previously regarded as *Biddulphia* spp. SEM investigations of genera of Biddulphiaceae showed, however, that they belong in *Odontella* partly because they have ocelli and labiate processes with long external tubes (Ross & Sims, 1971; Simonsen, 1974) whereas *Biddulphia* has pseudocelli.<sup>15</sup> Which species really belong to *Odontella* is still disputed (Round et al., 1990); here we include those which are usually regarded as planktonic.

**Genus *Odontella* C. A. Agardh 1832 (Plate 49, Table 62)**

**Type:** *Odontella aurita* (Lyngbye) C. A. Agardh.

**Basionym:** *Diatoma aurita* Lyngbye.

**Synonym:** *Biddulphia aurita* (Lyngbye) Brébisson.

<sup>15</sup> **Pseudocellus**—field of areolae decreasing in size from those on the main part of the valve.

**PLATE 49** *Odontella aurita*: (a) short chain; (b) valve view. *Odontella sinensis*: single cell with characteristic processes. *Odontella mobiliensis*: single cell, processes, and horns. After Cupp (1943). *Odontella longicurvis*: single cell, processes, and horns. After Cupp (1943). Scale bars = 20  $\mu\text{m}$ .

Odontella

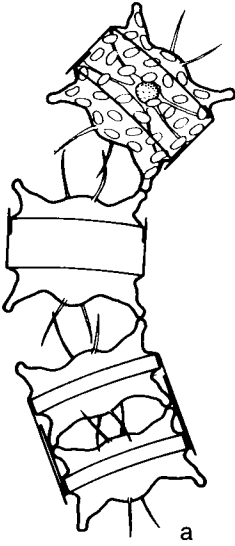

*O. aurita* —

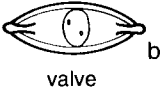

valve

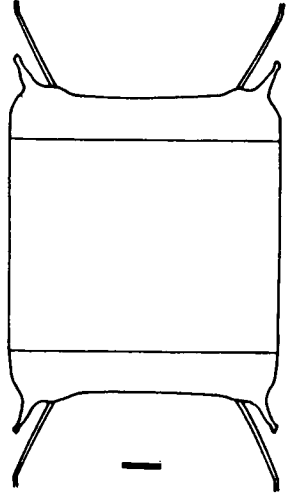

*O. sinensis*

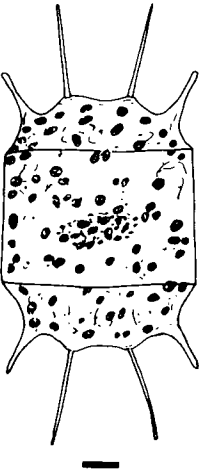

*O. mobiliensis*



*O. longicuris*

TABLE 62 Morphometric Data of *Odontella* spp.

Species	Apical axis ( $\mu\text{m}$ )	Valve areolae in 10 $\mu\text{m}$	Band areolae in 10 $\mu\text{m}$
<i>O. aurita</i>	10–97	8–11	8–14
<i>O. litigiosa</i>	30–80	— <sup>b</sup>	—
<i>O. longicuris</i>	15–110	12–17	18–21
<i>O. mobiliensis</i> <sup>a</sup>	45–200	14–16	17–18
<i>O. regia</i> <sup>a</sup>	90–200	14	16
<i>O. simensis</i>	90–260	16–18	—
<i>O. weissflogii</i>	60–84	—	—

<sup>a</sup> *O. mobiliensis*, apical axis, usually 40–80  $\mu\text{m}$ ; *O. regia*, apical axis usually >100  $\mu\text{m}$  (Hustedt, 1930).

<sup>b</sup> —, No data.

**References:** Lyngbye, 1819, p. 182, Plate 62, Fig. D; Agardh, 1832, p. 56; Brébisson & Godey, 1838, p. 12; Bailey, 1851, p. 40, Plate 2, Figs. 34 and 35; Schultze, 1858, p. 341; Schultze, 1859, p. 21; Greville, 1859b, p. 163, Plate 8, Fig. 10; Greville, 1866, p. 81, Plate 9, Fig. 16; Grunow, 1884, p. 58; Van Heurck, 1880–1885, Plate 101, Figs. 4–6; Van Heurck, 1909, p. 40, Plate 10, Fig. 141; Karsten, 1905, p. 122, Plate 17, Figs. 2 and 3; Hustedt, 1930, pp. 837, 840, and 846, Figs. 493, 495, and 501; Cupp, 1943, pp. 153, 154, and 161, Figs. 110–112; Hendey, 1964, pp. 103–105, Plate 20, Figs. 1 and 3, Plate 24, Fig. 6; Drebes, 1974, pp. 85, 90, and 91, Figs. 70, 73, and 76; Simonsen, 1974, p. 26; Hoban et al., 1980, p. 594, Figs. 15–38; Hoban, 1983, p. 283; Takano, 1984; Takano, 1990, pp. 300–303.

Generic characters:

Valves elliptical or lanceolate (bipolar).

An elevation (horn) with an ocellus at each pole.

Cells in straight (united by both elevations) or in zigzag chains (united by one elevation).

Two or more labiate processes per valve, usually with long external tubes.

Numerous small chloroplasts lying against valve wall.

Characters showing differences between species:

Planktonic species with weakly littoral with coarsely silicified cell wall.

Curvature of valve face.

- Position of processes.
- Direction of external tubes of processes.
- Shape and direction of elevations.
- Valve wall spinose or not.
- The presence or absence of resting spore formation.

### KEY TO SPECIES

- 1a. Cell wall coarsely silicified, valve face between elevations evenly inflated . . . . . 2
- 1b. Cell wall weakly silicified, middle part of valve face shaped in various ways. . . . . 3
- 2a. Valve wall with shorter or longer spines, elevations robust, slightly divergent . . . . . *O. litigiosa*<sup>16</sup> (Van Heurck) Hoban in Hoban et al.
- 2b. Valve wall coarsely areolated with no spines, elevations obtuse, inflated at base, divergent . . . . . *O. aurita* (Lyngbye) C. A. Agardh
- 3a. Processes at a fair distance from the elevations. . . . . 4
- 3b. Processes close to slender elevations, valve face between processes flat or concave. . . . . *O. sinensis*<sup>16</sup> (Greville) Grunow
- 4a. Elevations prominent, valve face flat or concave or bulging in the middle . . . . . 5
- 4b. Elevations inconspicuous, often more than two processes, divergent in direction, valve face flat or evenly convex . . . . . *O. weissflogii*<sup>16</sup> (Janisch) Grunow
- 5a. Processes close together on a narrow, bulging middle part of valve face, external tubes diverging, elevations in perivalvar direction . . . . . *O. longicuris*<sup>16</sup> (Greville) Hoban
- 5b. Middle part of valve face flat or slightly concave, external tubes of processes and elevations diverging . . . . . *O. mobiliensis*<sup>16</sup> (Bailey) Grunow

### Distribution:

*O. aurita*—cosmopolitan?, “usually in long chains attached to a substratum” (Hendey, 1964).

*O. litigiosa* and *O. weissflogii*—southern cold water region.

*O. longicuris*—warm water region to temperate.

*O. mobiliensis*, *O. sinensis*, and *O. regia*—cosmopolitan?

**How to identify:** The species may be identified in water mounts.

<sup>16</sup> Basionyms: *Biddulphia litigiosa* Van Heurck, *Biddulphia sinensis* Greville, *Biddulphia weissflogii* Janisch, *Biddulphia longicuris* Greville, *Zygoceros* (*Denticella*?) *mobiliensis* Bailey, respectively. Synonyms: *Biddulphia mobiliensis* (Bailey) Grunow in Van Heurck and *Biddulphia striata* Karsten (= *O. weissflogii*), respectively.

**Remarks:** *Odontella regia* (Schultze) Simonsen (basionym: *Denticella regia* Schultze) is close to *O. mobiliensis*. The Antarctic species have resting spores or appear in various phases (Hoban et al., 1980).

## PENNATE DIATOMS

### Order Bacillariales

Terminology specific to Pennate diatoms (Anonymous, 1975; Mann, 1978; Ross et al., 1979; Takano, 1983; Round et al., 1990): (Fig. 17)

**Apical pore field**—area of small pores at the apices of the valves; the pores are usually arranged in longitudinal rows, otherwise similar to the ocellus of the centric diatoms.

**Apical slit field**—area of elongate pores (slits) at the apices of the valves; the pores (slits) are separated laterally by long bars.

**Foot pole (basal pole) and head pole (apical pole)**—mainly used for cells in stellate, radiating, and bundle-shaped colonies in which neighboring cells are joined by valve faces of the foot poles; head pole is the other cell end.

**Sternum**—an elongate part of the valve where areolae are sparse (relative to the rest of the valve) or missing and which is often thickened pervalvarly (Mann 1978, p. 27); here used for the former pseudoraphe or axial area.

**Striae**—Parallel striae are perpendicular to the median line of the valve or to the raphe (Figs. 17a and 17c). Radiate striae are inclined from the valve

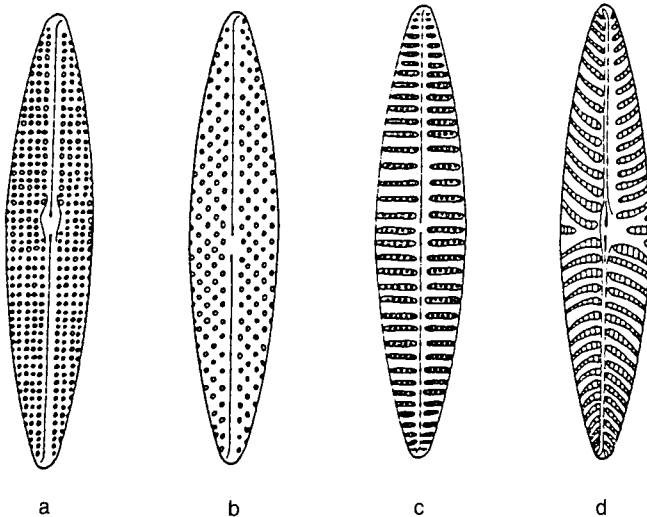

FIGURE 17 Valve striation in pennate diatoms. (a) Parallel striae; (b) radiate striae; (c) lineate, parallel striae; and (d) lineate, radiate striae.

margin toward the center of the valve (Figs. 17b and 17d). Convergent striae are inclined from the valve margin toward the apex. Lineate striae are crossed by finer longitudinal striation (Figs. 17c and 17d).

Whereas the pores and the slits will hardly be seen, the presence of an apical field is often recognized with LM as an open area lacking any resolvable structure.

### Suborder Fragilariineae—Araphid pennate diatoms

#### Family Fragilariaceae Greville 1833

The family is poorly represented in marine phytoplankton; *Asterionellopsis glacialis* and *A. kariana* may be the only species dealt with in this chapter that may be characterized as being truly marine planktonic. It should be noted that *A. glacialis* also occurs in the surf zone communities (Lewin & Norris, 1970). *Striatella* is attached to a substratum by a mucilage stalk although it is often found in plankton collected close to the coast, as is also the only *Fragilaria* species mentioned in this chapter. *Synedropsis hyperborea* is fairly common in Arctic plankton but, like other *Synedropsis* species, it may be more common on ice and as an epiphyte on other diatoms, especially on *Melosira arctica* (Syvertsen, 1991, Table 1).

#### Common characters:

One labiate process near one or both apices.

One apical pore or slit field at each apex.

Uniseriate striae of poroid areolae.

Numerous(?) narrow bands.

#### Genus *Asterionellopsis* Round in Round et al., 1990 (Plate 50)

**Type:** *Asterionellopsis glacialis* (Castracane) Round in Round et al., 1990

**Basionym:** *Asterionella glacialis* Castracane.

**Synonym:** *Asterionella japonica* Cleve in Cleve & Möller.

**References:** Cleve & Möller, 1882, p. 3, No. 307; Cleve & Grunow, 1880, p. 110, Plate 6, Fig. 121; Castracane, 1886, p. 50, Plate 14, Fig. 1; Cupp, 1943, pp. 188–190, Figs. 138 and 139; Hustedt, 1959, pp. 254–256, Figs. 734 and 735; Körner, 1970, pp. 616–632, Figs. 36–41 and 108–128; Round et al., 1990, pp. 392 and 393; Takano, 1990, pp. 304–307.

#### Generic characters:

Cells with dissimilar ends in valve as well as in girdle views.

Cells joined by valve faces of expanded foot poles in star-like, spiral chains.

Foot poles angular in girdle view and more or less rounded in valve view.

Apical pore or slit fields (EM).

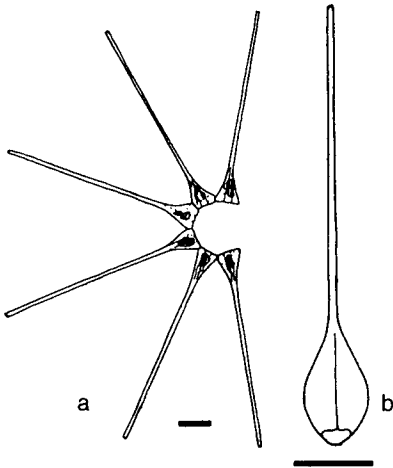

*Asterionellopsis glacialis*

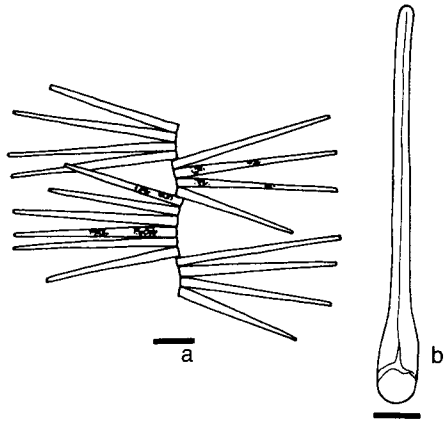

*Bleakeleya notata*

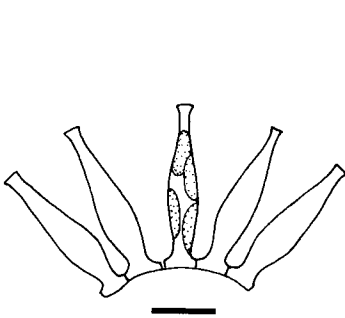

*Asterionellopsis kariana*

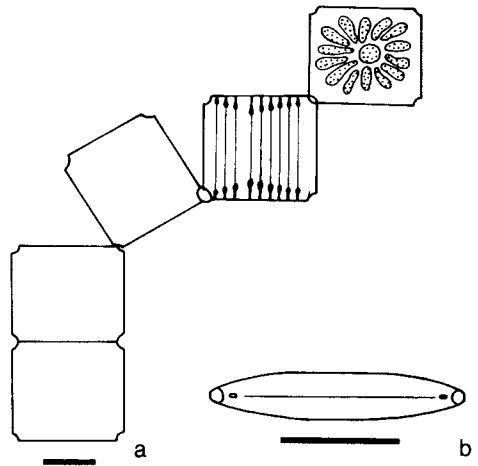

*Striatella unipunctata*

**PLATE 50** *Asterionellopsis glacialis*: (a) chain in girdle view. Scale bar = 20  $\mu\text{m}$ ; (b) valve view, with apical field and sternum indicated in head pole. After Cupp (1943). Scale bar = 10  $\mu\text{m}$ . *Asterionellopsis kariana*: chain in girdle view. Scale bar = 10  $\mu\text{m}$ . *Bleakeleya notata*: (a) chain in girdle view. Scale bar = 20  $\mu\text{m}$ ; (b) valve view, with sternum and apical field. After Hustedt (1959). Scale bar = 10  $\mu\text{m}$ . *Striatella unipunctata*: (a) chain in broad girdle view, with chloroplasts (top cell) and septa (second cell from top); (b) valve view, with sternum, apical labiate processes, and pore fields. Scale bars = 20  $\mu\text{m}$ .

## KEY TO SPECIES

- 1a. Cells in girdle view narrow with straight parallel sides and greatly expanded triangular foot pole; foot pole greatly widened and rounded in valve view, one or two chloroplasts in foot pole only . . . . .  
 . . . . . *A. glacialis* (Castracane) Round
- 1b. Cells in girdle view broad at foot pole, then suddenly constricted, then gradually widening again to the middle, then tapering toward head pole, chloroplasts 6–10 small rounded plates, scattered throughout the cell . . . . .  
 . . . . . *A. kariana*<sup>17</sup> (Grunow) Round

**Morphometric data:**

*A. glacialis*—apical axis, 30–150  $\mu\text{m}$ ; length of expanded part, 10–23  $\mu\text{m}$  (ca. one-fourth of total length); transapical axis of expanded part, 8–12  $\mu\text{m}$ ; 28–34 transapical striae in 10  $\mu\text{m}$ .

*A. kariana*—Apical axis, 16–68  $\mu\text{m}$ ; transapical axis of foot pole, ca. 3  $\mu\text{m}$ ; at constriction, ca. 1  $\mu\text{m}$ ; median part, ca. 3–4  $\mu\text{m}$ ; head pole, ca. 0.5  $\mu\text{m}$  (Körner, 1970).

**Distribution:**

*A. glacialis*—cosmopolitan, sometimes abundant in plankton in cold to temperate coastal waters.

*A. kariana*—northern cold water region to temperate (?).

**How to identify:** Whole cells in girdle view show sufficient details that the two species are distinguishable.

**Remarks:** *Asterionella socialis* Lewin & Norris (Lewin & Norris, 1970, p. 145), which was described from the surf zone in the State of Washington, should also be transferred to *Asterionellopsis* (Round et al., 1990, p. 392). *Asterionellopsis glacialis* cultured for some time regularly loses the narrow part of the cells and occurs as triangular or almost circular cells (G. Hasle and E. Syvertsen, personal observations; Körner, 1970, Figs. 119–122). Whereas both poles of *A. glacialis* have apical slit fields (Körner, 1970, Figs. 108–110; Hasle, 1973c, Figs. 22–25; Takano 1983, p. 27; Round et al., 1990, p. 393; Takano, 1990, p. 304), the broad foot pole of *A. kariana* carries pores and the narrow head pole slits (Körner, 1970, Fig. 126; Takano, 1990, pp. 306 and 307) and *A. socialis* seems to be like *A. kariana* in this respect (Lewin & Norris, 1970, Fig. 15).

**Genus** *Bleakeleya* Round in Round et al., 1990

**Type:** *Bleakeleya notata* (Grunow) Round in Round et al.

Monospecific genus.

<sup>17</sup> Basionym: *Asterionella kariana* Grunow in Cleve & Grunow



***Bleakeleya notata*** (Grunow) Round in Round et al. (Plate 50)

**Basionym:** *Asterionella bleakeleyi* var. *notata* Grunow.

**References:** Grunow, 1867, p. 2; Hustedt, 1959, p. 254, Fig. 733; Round et al., 1990, p. 394.

Cells linear in girdle and valve views with dissimilar ends. Cells united by valve faces of expanded foot poles, in flat or twisted chains. Head pole rounded in valve view. Foot pole in valve view slightly inflated with a more or less angular or rounded outline, crossed by a transverse bar from which a narrow sternum rises. Basal part of foot pole with smaller areolae in radiating striae. Chloroplasts—numerous small granules scattered throughout the cell.

**Morphometric data:** Apical axis, 50–170  $\mu\text{m}$ ; transapical axis of foot pole, 4–10  $\mu\text{m}$ ; of head pole, 1.6–3  $\mu\text{m}$ ; 30–36 transapical striae in 10  $\mu\text{m}$  (Körner, 1970).

**Distribution:** Warm water region.

**How to identify:** The shape of the colonies characterizes this species. Identification based on single cells or valves requires cleaned material mounted in a medium of a high refractive index.

**Genus *Striatella*** C. A. Agardh 1832

**Lectotype:** *Striatella unipunctata* (Lyngbye) C. A. Agardh (*vide* Ehrenberg, 1838, pp. 202 and 230).

Monospecific genus (as proposed by Round et al., 1990, p. 432).

***Striatella unipunctata*** (Lyngbye) C. A. Agardh (Plate 50)

**Basionym:** *Fragilaria unipunctata* Lyngbye.

**References:** Lyngbye, 1819, p. 183, Plate 62, Fig. G; Agardh, 1832, p. 61; Cupp, 1943, p. 173, Fig. 122; Hustedt, 1959, p. 32, Fig. 560; Hendey, 1964, p. 161, Plate 26, Figs. 17 and 18.

**Girdle view:** Tabular with corners appearing as being cut off. Cells united to form ribbons or zigzag chains. Numerous open bands with narrow septa. Chloroplasts granular to oblong and radially arranged.

**Valve view:** Lanceolate with distinct apical pore fields, slightly sunk in and surrounded by a rim (SEM), thus the impression of cut off corners when seen with LM. One labiate process at each pole. Valve areolae in three self-crossing line systems. Sternum narrow.

**Morphometric data:** Apical axis, 35–125  $\mu\text{m}$ ; transapical axis, 6–20  $\mu\text{m}$ ; 6–10 bands in 10  $\mu\text{m}$ ; areolae in 18–25 oblique lines in 10  $\mu\text{m}$ .

**Distribution:** Temperate species (Cupp, 1943).

**How to identify:** *Striatella unipunctata* is most easily identified as whole cells in girdle view in water mounts.

**Remarks:** *Tessella interrupta* Ehrenberg and *Hyalosira delicatula* Kützing, both listed as *Striatella* species by Hustedt (1959), have been transferred to *Microtabella* F. E. Round (Round et al., 1990).

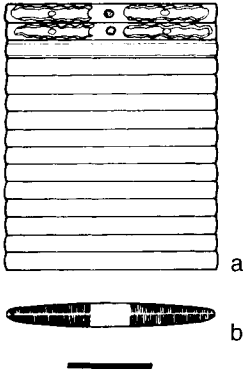

*Fragilaria striatula*

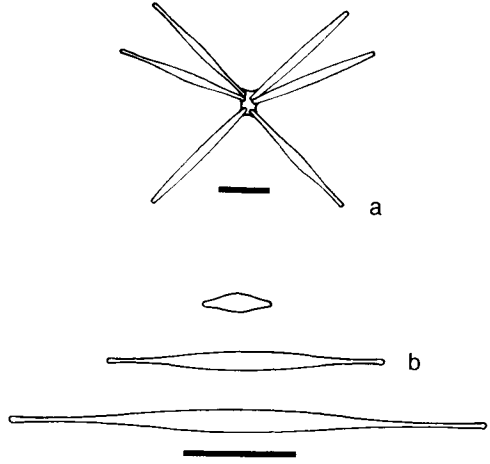

*Synedropsis hyperborea*

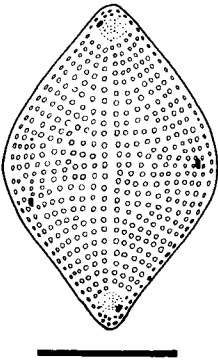

*Adoneis pacifica*

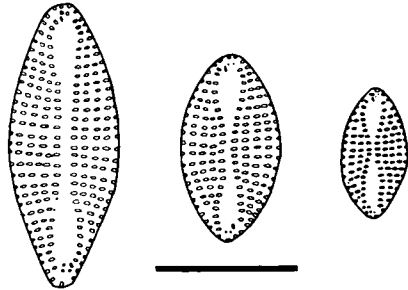

*Delphineis sureirella*

PLATE 51 *Fragilaria striatula*: (a) ribbon in broad girdle view; (b) valve view with striation and sternum. Scale bar = 20  $\mu$ m. *Synedropsis hyperborea*: (a) stellate colony, with cells in girdle and valve views; (b) valves, size variation. Scale bars = 20  $\mu$ m. *Adoneis pacifica*: valve with areolation, apical pore fields and four labiate processes. After Andrews & Rivera (1987). Scale bar = 20  $\mu$ m. *Delphineis sureirella*: valves, size variation. Sternum broadened apically, apical pores, and labiate processes. After Hustedt (1959). Scale bar = 20  $\mu$ m.

***Fragilaria striatula* Lyngbye (Plate 51)**

**References:** Lyngbye, 1819, p. 183, Plate 63; Hustedt, 1959, p. 150, Fig. 663; Hasle & Syvertsen, 1981, Figs. 18–23.

**Girdle view:** Rectangular cells close together in ribbons, numerous narrow bands. Chloroplasts large, two per cell.

**Valve view:** Valves variable in silicification and outline, the latter varying from broadly to narrowly elliptical, and the shape of apices from rounded to slightly attenuate to almost capitate. A narrow sternum, parallel striae, a labiate process at one valve pole, and apical pore fields at each pole discernible with LM.

**Morphometric data:** Apical axis, 25–53  $\mu\text{m}$ ; transapical axis, 6–10  $\mu\text{m}$ ; 17–28 transapical striae in 10  $\mu\text{m}$ .

**Distribution:** *Fragilaria striatula* is benthic and a common epiphyte on larger algae but was also reported as a “neritic plankton species” by Hendey (1964). It was described from the Faeroe Is, North Atlantic, and is often recorded from other parts of the North Atlantic and from the Arctic. Due to the shape of the chains it may be confused with *Fragilariopsis* spp.

**How to identify:** *Fragilaria striatula* cannot be identified in girdle view and has to be examined in valve view as cleaned material mounted in a medium of a high refractive index.

**Remarks:** The typification of *Fragilaria* has been disputed. Williams & Round (1987) suggested that the genus name should be conserved for freshwater species. The marine *F. striatula* was placed into this genus by the author of the genus, and the type material has been examined with EM (Hasle & Syvertsen, 1981). Boyer (1927) designated the freshwater species *F. pectinalis* as the lectotype of *Fragilaria*. The identity of this species is obscure, however.

**Genus *Synedropsis* Hasle, Medlin, & Syvertsen 1994**

**Type:** *Synedropsis hyperborea* (Grunow) Hasle, Medlin, & Syvertsen.

***Synedropsis hyperborea* (Grunow) Hasle, Medlin, & Syvertsen (Plate 51)**

**Basionym:** *Synedra hyperborea* Grunow.

**Synonyms:** *Synedra hyperborea* var. *flexuosa* Grunow; *Synedra hyperborea* var. *rostellata* Grunow.

**References:** Grunow, 1884, p. 106, Plate 2, Figs. 4–6; Hustedt, 1959, p. 217, Fig. 709; Hasle et al., 1994, p. 249, Figs. 1–12, 17–21, 24–26, 31–38, 45–47, and 142a.

**Girdle view:** Cells narrowly linear in stellate colonies.

**Valve view:** Specimens of maximum length rostrate; smaller valves with shorter prolongations; smallest specimens almost lanceolate; some valves with irregular inflations and indentations. A labiate process at one valve apex, a narrow sternum, and transapical striae discernible with LM. Apical slit fields (EM).

**Morphometric data:** Apical axis, 13–96  $\mu\text{m}$ ; transapical axis, 2.5–4  $\mu\text{m}$ ; 25–27 transapical striae in 10  $\mu\text{m}$ .

**Distribution:** Northern cold water region, described from the undersurface of ice but often encountered in the plankton and as an epiphyte on *Melosira arctica*.

**How to identify:** *Synedropsis hyperborea* can probably be identified as whole cells in water mounts in Arctic material; in critical cases examination of many specimens mounted in a medium of a high refractive index using phase or interference contrast is needed to secure positive identification.

**Remarks:** The *Synedropsis* species are mainly living associated with sea ice, either attached to the ice itself or to the ice diatoms. The Arctic *S. hyperborea* and, probably more seldom, the Antarctic *S. recta* Hasle, Medlin, & Syvertsen and *S. hyperboreoides* Hasle, Syvertsen, & Medlin, are also found in the plankton close to the ice.

#### Family Rhaphoneidaceae Forti 1912

The habitat of the four genera dealt with here is shallow coastal water over sandy shores and mud and sand flats. They may be attached to sand grains or other particles [e.g., valves of other diatoms (Drebes, 1974)], but may be stirred up in turbulent water and thus become part of the plankton.

Characters common to *Adoneis*, *Delphineis*, *Neodelphineis*, and *Rhaphoneis*:

Cells solitary or in ribbons or zigzag or stellate colonies.

Cells rectangular in girdle view.

Valve outline linearly elliptical to broadly lanceolate, sometimes with produced apices or central inflation.

Large poroid areolae in uniseriate parallel or radiate striae.

Apical pore fields or one or two apical pores (EM).

One labiate process at each apex (one genus, *Adoneis*, usually with labiate processes also near the center of each lateral margin).

#### KEY TO GENERA

- 1a. Apical pore fields present . . . . . 2
- 1b. Apical pore fields missing (one or two small apical pores present). . . 3
- 2a. One labiate process at each valve apex. . . . . *Rhaphoneis*, p. 251
- 2b. One labiate process at each valve apex and usually also near center of lateral margins . . . . . *Adoneis*, p. 248
- 3a. Valve striae aligned across sternum . . . . . *Delphineis*, p. 248
- 3b. Valve striae alternate, not aligned across sternum *Neodelphineis*, p. 249

Genus *Adoneis* G. W. Andrews & P. Rivera 1987

Type: *Adoneis pacifica* G. W. Andrews & P. Rivera.

Monospecific genus.

*Adoneis pacifica* G. W. Andrews & P. Rivera (Plate 51)

Reference: Andrews & Rivera, 1987.

**Valve view:** Broadly lanceolate with smoothly rounded lateral margins and slightly produced rounded apices. Sternum narrow and distinct. Striae radiate. Single row of areolae on valve mantle continuous around apices.

An apical pore field at each pole. One labiate process at each pole and usually one near the center of one or both lateral margins.

**Morphometric data:** Apical axis, 29–95  $\mu\text{m}$ ; transapical axis, 20–47  $\mu\text{m}$ ; six to eight valve areolae in 10  $\mu\text{m}$ .

**Distribution:** Chilean coastal waters, California coastal waters (Lange, personal communication).

Genus *Delphineis* G. W. Andrews 1977, 1981 (Plate 51, Table 63)

Type: *Delphineis angustata* (Pantocsek) Andrews.

Basionym: *Rhaphoneis angustata* Pantocsek.

References: Ehrenberg, 1841a, p. 160, Plate 4, Fig. 12; Van Heurck, 1880–1885, Plate 36, Figs. 26 and 27; Boden, 1950, p. 406, Fig. 87; Hustedt, 1959, p. 173, Fig. 679; Drebes, 1974, p. 103, Figs. 84a and 84b; Simonsen, 1974, p. 35, Plate 23, Figs. 2–8; Andrews, 1977, 1981; Fryxell & Miller, 1978, p. 116, Figs. 1–10; Round et al., 1990, p. 410.

The genus comprises several fossil species (Andrews, 1977).

Characters common to recent species:

Cells solitary or in shorter or longer ribbons.

Valve outline linear or broadly elliptical to lanceolate.

Striae parallel to slightly radiate.

Rows of two or three areolae continue around valve apices.

TABLE 63 Morphometric Data of *Delphineis* spp.

Species	Pervalvar axis ( $\mu\text{m}$ )	Apical axis ( $\mu\text{m}$ )	Transapical axis ( $\mu\text{m}$ )	Areolae in 10 $\mu\text{m}$	Striae in 10 $\mu\text{m}$
<i>D. karstenii</i>	7–12.5	27–86	6–7	—	8–10
<i>D. surirella</i>	—	17–53	8–25	7–8	7–12
<i>D. surirelloides</i>	—	14–40	5.5–7.5	—	12–14

Note. —, No data.

Two small pores at each valve apex (usually not seen with LM).  
Several chloroplasts.

### KEY TO SPECIES

- 1a. Valves linear or linearly elliptical to oval. . . . . 2  
 1b. Valves broadly elliptical to lanceolate with slightly produced bluntly rounded apices, sternum distinct, narrow, and widening slightly near apices, cells solitary or in loose chains attached to particles (e. g. sand grains) . . . . . *D. surirella*<sup>18</sup> (Ehrenberg) G. W. Andrews  
 2a. Valves linear with rounded apices to slightly inflated in center, wide sternum, long chains, planktonic . . . . .  
 . . . . . *D. karstenii*<sup>18</sup> (Boden) G. Fryxell in Fryxell & Miller  
 2b. Valves linearly elliptical to broadly elliptical with broadly rounded apices, sternum variable in width, widening slightly near apices. . . . .  
 . . . . . *D. surirelloides*<sup>18</sup> (Simonsen) G. W. Andrews

### Distribution:

*D. karstenii*—warm water region—off southwest coast of Africa (Fryxell & Miller, 1981).

*D. surirella*—“cool to temperate seas” (Andrews, 1981), e.g., North Sea (Drebes, 1974); Chile (Andrews & Rivera, 1987).

*D. surirelloides*—warm water region—Indian Ocean (Simonsen, 1974).

### Genus *Neodelphineis* Takano 1982 (Plate 52, Table 64)

Type: *Neodelphineis pelagica* Takano.

References: Taylor, 1967, p. 440, Plate 3, Figs. 22–24; Simonsen, 1974, p. 36, Plate 23, Figs. 8–18; Takano, 1982; Hernández-Becerril, 1990; Takano, 1990, pp. 310–311; Round et al., 1990, p. 412; Hasle & Syvertsen, 1993, p. 309, Figs. 32–41.

### Generic characters:

Cells solitary or in zigzag or stellate chains.

Valve outline linear to broadly elliptical with broadly rostrate apices or inflated at the center and sometimes at the apices.

Sternum narrow.

Striae parallel to slightly radiate.

Single row of valve mantle areolae continues around apices.

Usually one (occasionally two) fine pore near each apex (EM).

<sup>18</sup> Basionyms: *Zygodon surirella* Ehrenberg, *Fragilaria karstenii* Boden, and *Rhaphoneis surirelloides* Simonsen, respectively.

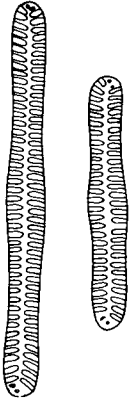

*Neodelphineis indica*

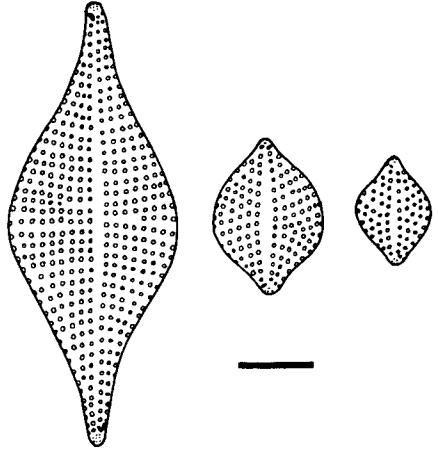

*Rhaphoneis amphiceros*

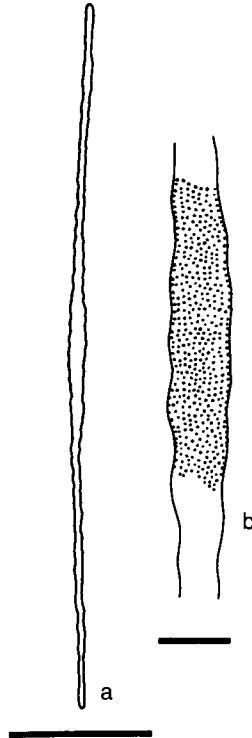

*Toxarium undulatum*

TABLE 64 Morphometric Data of *Neodelphineis* spp.

Species	Apical axis ( $\mu\text{m}$ )	Transapical axis ( $\mu\text{m}$ )	Striae in 10 $\mu\text{m}$
<i>N. indica</i>	8–37	1.5–ca. 3	18–24
<i>N. pelagica</i>	5–23	2.8–5.8	14–18

## KEY TO SPECIES

- 1a. Valve outline varying according to cell size: larger cells linearly elliptical, median cells broadly elliptical with broadly rostrate ends, smallest cells lanceolate . . . . . *N. pelagica* Takano  
 1b. Valve outline of all cell sizes: linear, inflated at the center and less so at apices . . . . . *N. indica*<sup>19</sup> (F. J. R. Taylor) Hasle

## Distribution:

*N. indica*—warm water region to temperate (?)—Indian Ocean, Gulf of Mexico, Gulf of California, and Central and North Pacific.

*N. pelagica*—warm water region to temperate (?)—Japan, coasts of Texas and Florida (Round et al., 1990), and Pacific Ocean off Mexico (Hernández-Becerril, 1990).

**Remarks:** A further distinctive feature of *Neodelphineis* compared to *Delphineis* is the presence of pointed, raised single spines located on the interstriae on the edge of the valve face (SEM). The light micrographs of *Synedra indica* in Simonsen (1974, Plate 23, Figs. 9–18) illustrate the invariability of the valve outline of *N. indica* (11–37  $\mu\text{m}$  long, Simonsen 1974, Figs. 9–14) and a part of the variability of the valve outline of *N. pelagica* (ca. 15–24  $\mu\text{m}$  long; Simonsen 1974, Figs. 15–18).

Genus *Rhaphoneis* Ehrenberg 1844

**Lectotype:** *Rhaphoneis amphiceros* (Ehrenberg) Ehrenberg (*vide* Boyer, 1927, p. 190).

<sup>19</sup> Basionym: *Synedra indica* F. J. R. Taylor.

PLATE 52 *Neodelphineis indica*: valves showing outline, striation, apical pores and labiate processes. Scale bar = 10  $\mu\text{m}$ . *Rhaphoneis amphiceros*: valves, size variation. Striation, sternum, apical pore fields, and labiate processes. After Hustedt (1959). Scale bar = 10  $\mu\text{m}$ . *Toxarium undulatum*: (a) valve outline. Scale bar = 100  $\mu\text{m}$ ; (b) central part of valve, showing structure. Scale bar = 10  $\mu\text{m}$ . After Cupp (1943).



The lectotype seems to be the only commonly recorded recent species left in this genus.

***Rhaphoneis amphiceros* (Ehrenberg) Ehrenberg (Plate 52)**

**Basionym:** *Cocconeis amphiceros* Ehrenberg.

**References:** Ehrenberg, 1841b, p. 206; Ehrenberg, 1844a, pp. 74 and 87; Hustedt, 1959, p. 174, Fig. 680; Hendey, 1964, p. 154, Plate 26, Figs. 1–4; Drebes, 1974, p. 101, Fig. 83; Round et al., 1990, p. 406.

Cells solitary and often attached to sand grains. Valve outline broadly elliptical or lanceolate with produced almost capitate apices to subcircular. Striae parallel or radiating. Sternum narrow and lanceolate. Small and distinct (LM) apical pore fields. Chloroplasts small and numerous.

**Morphometric data:** Apical axis, 20–100  $\mu\text{m}$ ; transapical axis, 18–25  $\mu\text{m}$ , six or seven striae in 10  $\mu\text{m}$ .

**Distribution:** Probably cosmopolitan.

**How to identify:** Diatoms belonging to Rhaphoneidaceae can only be identified in valve view. The most coarsely silicified specimens may be identified in water mounts. Examination of cleaned valves mounted in a medium of a high refractive index is recommended.

**Family Toxariaceae** F. E. Round 1990

*Toxarium undulatum* Bailey and *T. hennedyanum* Grunow are, at present, probably the only species in this family (Round et al., 1990). They are not typical plankton forms although *T. hennedyanum* was characterized as a “neritic plankton species” (Hendey 1964, p. 164). *Toxarium undulatum* was first found “attached in considerable numbers to *Sargassum vulgare*, in Narragansett Bay” (Bailey, 1854, p. 15), and Bailey’s two other records of *T. undulatum* were also from *Sargassum*.

**Genus *Toxarium*** J. W. Bailey 1854 (Plate 52)

**Type:** *Toxarium undulatum* J. W. Bailey.

**Synonym:** *Synedra undulata* (J. W. Bailey) Gregory.

**References:** Bailey, 1854, p. 15, Figs. 24 and 25; Gregory, 1857, pp. 531–533, Plate 14, Figs. 107 and 108; Van Heurck, 1880–1885, Plate 42, Fig. 3; Hustedt, 1959, pp. 222–224, Figs. 713 and 714; Round et al., 1990, p. 422.

**Generic characters:**

Needle like in valve and girdle views.

Valves slightly expanded at both apices and at the center.

No distinct sternum.

Areolae scattered over valve face.

Labiata processes and apical pore fields absent.

*Toxarium undulatum* has undulated valve margins; *T. hennedyanum* (Gregory) Grunow in Van Heurck (syn. *Synedra hennedyana* Gregory) has smooth valve margins.

**Morphometric data:**

*T. hennedyanum*—apical axis, 300–900  $\mu\text{m}$ ; transapical axis, 6–8  $\mu\text{m}$  in valve center, 5–6  $\mu\text{m}$  at the apices, and 2  $\mu\text{m}$  in between; 9–11 striae in 10  $\mu\text{m}$  (Hustedt, 1959).

*T. undulatum*—apical axis, up to 600  $\mu\text{m}$ ; 10–18 striae in 10  $\mu\text{m}$  near apices (Hendey, 1964).

**Distribution:** Common, especially in tropical/subtropical waters (Round et al., 1990), but also occasionally in temperate waters.

**How to identify:** These two species are coarsely structured and may be identified in valve view in water mounts.

**Family Thalassionemataceae Round 1990**

In contrast to the other araphid families, Thalassionemataceae is exclusively marine and planktonic.

**Family characters:**

Cells solitary or in colonies of various types.

Cells needle shaped, often long, twisted, sometimes curved and expanded in the middle and at the apices.

Sternum usually wide and often varying in width along the cell length.

Areolae loculate with internal foramina and external vela (SEM).

Areolae circular to elongate transapically.

One labiate process at each end.

Apical spine(s) usually present at one or both ends.

Apical fields absent.

Marginal spines present or absent.

Numerous small chloroplasts scattered throughout the cell.

**KEY TO GENERA**

- 1a. Marginal spines lacking . . . . . 2
- 1b. Marginal spines present . . . . . *Thalassiothrix*, p. 263
- 2a. Cells solitary or in colonies of various shapes, cells usually straight. . . 3
- 2b. Cells solitary or in bundles, bow shaped . . . . . *Trichotoxon*, p. 267
- 3a. Cells in stellate, zigzag, or fan-shaped colonies, cells not twisted. . . . .  
 . . . . . *Thalassionema*, p. 257
- 3b. Cells solitary or in stellate or fan-shaped colonies, cells twisted . . . . .  
 . . . . . *Lioloma*, p. 254

Additional characters to distinguish between genera (EM)

Size of vela compared to that of foramina.

Velum reticulate or consisting of struts (bars).

**Genus *Lioloma*** Hasle gen. nov. (Plates 53 and 54, Table 65)

**Type:** *Lioloma elongatum* (Grunow) Hasle comb. nov.

**Basionym:** *Thalassiothrix elongata* Grunow in Van Heurck.

**Synonym:** *Thalassiothrix vanhoeffenii* Heiden in Heiden & Kolbe.

**References:** Van Heurck, 1880–1885, Plate 37, Fig. 9; Karsten 1907, p. 397, Plate 46, Fig. 11; Pavillard, 1916, p. 39, Plate 2, Fig. 3; Heiden & Kolbe, 1928, p. 566, Plate 6, Figs. 124 and 125; Allen & Cupp, 1935, p. 153, Fig. 95; Hustedt, 1959, p. 248, Fig. 728; Cupp, 1943, p. 185, Fig. 136; Simonsen, 1974, p. 38, Plate 24, Fig. 5, Plate 25, Figs. 1–3; Hallegraeff, 1986, pp. 70 and 72.

Generic characters:

Cells solitary or united into colonies by valve surface of foot pole.

Cells more or less twisted.

Cells heteropolar, head pole with spines, and foot pole wedge shaped in valve and girdle views.

Sternum narrow near valve apices and usually wider in the rest of the valve.

Irregularly located marginal structures, each evident as an empty space in the place of an areola.<sup>20</sup>

Foramina of about the same size as reticulate vela (Plate 54, SEM).

The two lips of the labiate process dissimilar in size (Plate 54, Fig. 1a; parrot beak shaped process in Hallegraeff, 1986) (SEM).

## KEY TO SPECIES

- 1a. Head pole bluntly rounded or almost square, with two spines, the other end (foot pole) smoothly tapering, areolae in two or more rows along each margin . . . . . 2
- 1b. Head pole in valve view narrowly club shaped, with one spine, the other end suddenly constricting before a fairly long tapering apex, large marginal areolae in one row along each valve margin, sternum wide except near the tapering apex. . . . . *L. elongatum*<sup>21</sup> (Grunow) Hasle comb. nov.

<sup>20</sup> These structures may be difficult to observe with LM or may be lacking. With EM they are seen as flattened bubbles of about the same size as an areola, with a central opening and positioned on the internal valve surface (Plate 54, Figs. 1a–1c, 2b, and 3b, SEM).

<sup>21</sup> Basionyms: *Thalassiothrix elongata* Grunow in Van Hureck, *Thalassiothrix delicatula* Cupp and *Thalassiothrix mediterranea* var. *pacifica* Cupp, respectively. Synonym of *Lioloma elongatum*: *Thalassiothrix vanhoeffenii* Heiden.

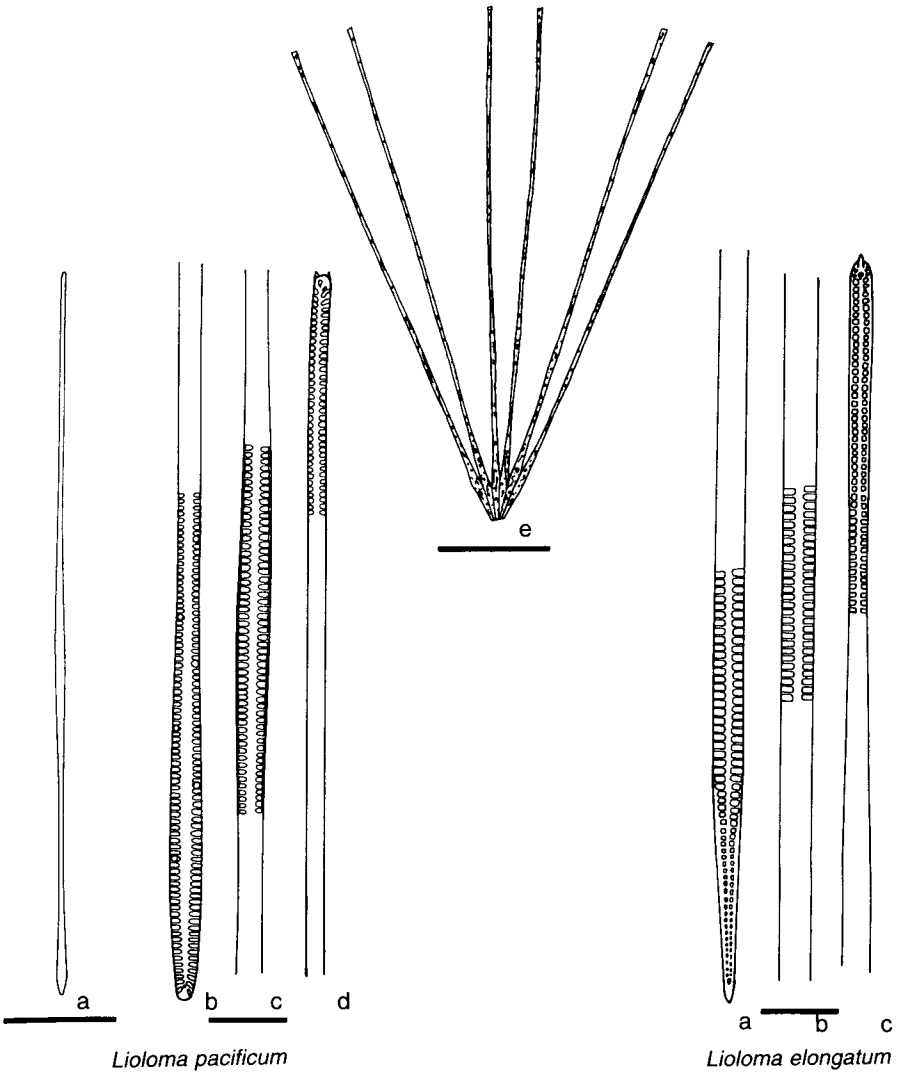
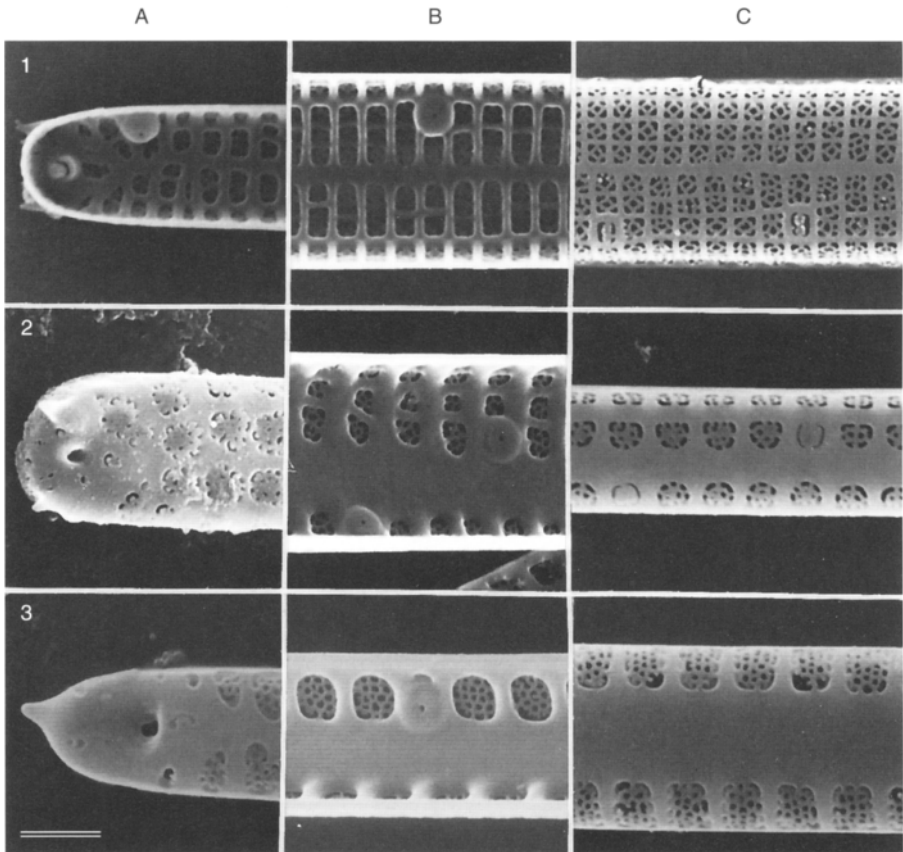

PLATE 53 *Lioloma pacificum* (a) valve outline. Scale bar = 100  $\mu\text{m}$ ; (b) foot pole, with valve structure; (c) median part of valve; (d) head pole with two apical spines. Scale bar = 10  $\mu\text{m}$ ; (e) colony. Scale bar = 100  $\mu\text{m}$ . After Cupp (1943). *Lioloma elongatum* : (a) foot pole; (b) median part of valve; (c) head pole with one apical spine. Scale bar = 10  $\mu\text{m}$ .

2a. Valve widened at head pole (valve and girdle views), gradually narrower until about one-third cell length from head pole, then wider and about the same width until tapering foot pole. Cell distinctly twisted. Structure very delicate. Solitary . . . . *L. delicatulum*<sup>21</sup> (Cupp) Hasle comb. nov.



**PLATE 54** Scanning electron micrographs. (1) *Lioloma delicatum*: (a) internal view of head pole, two apical spines, "parrot beak"-shaped labiate process, two or three marginal rows of foramina, and one "bubble shaped" structure; (b) part of valve, internal view with narrow sternum, three marginal rows of foramina, and one "bubble-shaped" structure; (c) part of valve, external view with narrow sternum, vela divided into several compartments, and external openings (?) of two bubble-shaped structures. (2) *Lioloma pacificum*: (a) external view of head pole with two apical spines, external opening of labiate process, and vela in irregular pattern; (b) part of valve, internal view with wide sternum, three marginal rows of foramina, and two bubble-shaped structures; (c) part of valve, external view with wide sternum, and two marginal rows of vela. (3) *Lioloma elongatum*: (a) external view of head pole with one apical spine and external opening of labiate process; (b) part of valve, internal view with wide sternum, one marginal row of foramina, and one bubble-shaped structure; (c) part of valve, external view with wide sternum, and one marginal row of vela. Scale bar = 1  $\mu\text{m}$ .

TABLE 65 Morphometric Data of *Lioloma* spp.

Species	Pervalvar axis ( $\mu\text{m}$ )	Apical axis ( $\mu\text{m}$ )	Transapical axis ( $\mu\text{m}$ )	Areolae in 10 $\mu\text{m}$
<i>L. delicatulum</i>	—	1120–1920	1–4	19–24
<i>L. elongatum</i>	4–6.6	990–2040	3–4	8–14
<i>L. pacificum</i>	1.8–7	525–1076	1.5–5	14–19

Note. —, No data. Size of pervalvar and transapical axes varies along the cell length in girdle as well as in valve views (Plate 53); the ranges given in Table 65 indicate the variation along the apical axis of the particular species.

- 2b. Valve width almost the same from head pole until somewhat enlarged for a short distance about one-third from wedge-shaped, blunt-pointed foot pole. Cells in star or fan-shaped colonies . . . . .  
 . . . . . *L. pacificum*<sup>21</sup> (Cupp) Hasle comb. nov.

#### Distribution:

*L. delicatulum*—warm water region to temperate—off Portugal, NW Africa, Mediterranean, Gulf of Mexico, Indian Ocean, off California, South Pacific.

*L. elongatum*—warm water region—Java, Indian Ocean, Gulf of Thailand.

*L. pacificum*—warm water region to temperate—Mediterranean, Indian Ocean, South Atlantic.

**Remarks:** *Lioloma elongatum* is readily distinguished in LM by the coarser areolae (Table 65), the single apical spine, and the long tapering foot pole (Plate 53); *L. pacificum* is distinguished by the blunt, not especially widened head pole with two small spines and the more or less distinct widening near the foot pole (Plate 53), and *L. delicatulum* by the delicate areolation (Table 65), and in valve view, the wide head-pole.

The diatom we identify as *Lioloma elongatum* has the morphological features illustrated for *T. elongata* in Van Heurck (1880–1885) and described and illustrated for *T. vanhoeffenii* in Heiden & Kolbe (1928).

**Genus *Thalassionema*** Grunow ex Mereschkowsky 1902 (Plates 55, 56, and 57, Table 66)

**Type:** *Thalassionema nitzschioides* (Grunow) Grunow ex Hustedt.

**Basionym:** *Synedra nitzschioides* Grunow.

**Synonym:** *Thalassiothrix nitzschioides* (Grunow) Grunow in Van Heurck.

**References:** Grunow, 1862, p. 403, Plate 5, Figs. 18a and 18b; Grunow, 1863, p. 140, Plate 5, Figs. 18a–18c; Greville, 1865a, p. 4, Plate 5, Figs. 5 and 6; Cleve & Grunow, 1880, p. 109; Van Heurck, 1880–1885, Plate 37, Figs. 11–13, Plate 43, Figs. 7–10; Mereschkowsky, 1902, p. 78, 1903

*Thalassionema*

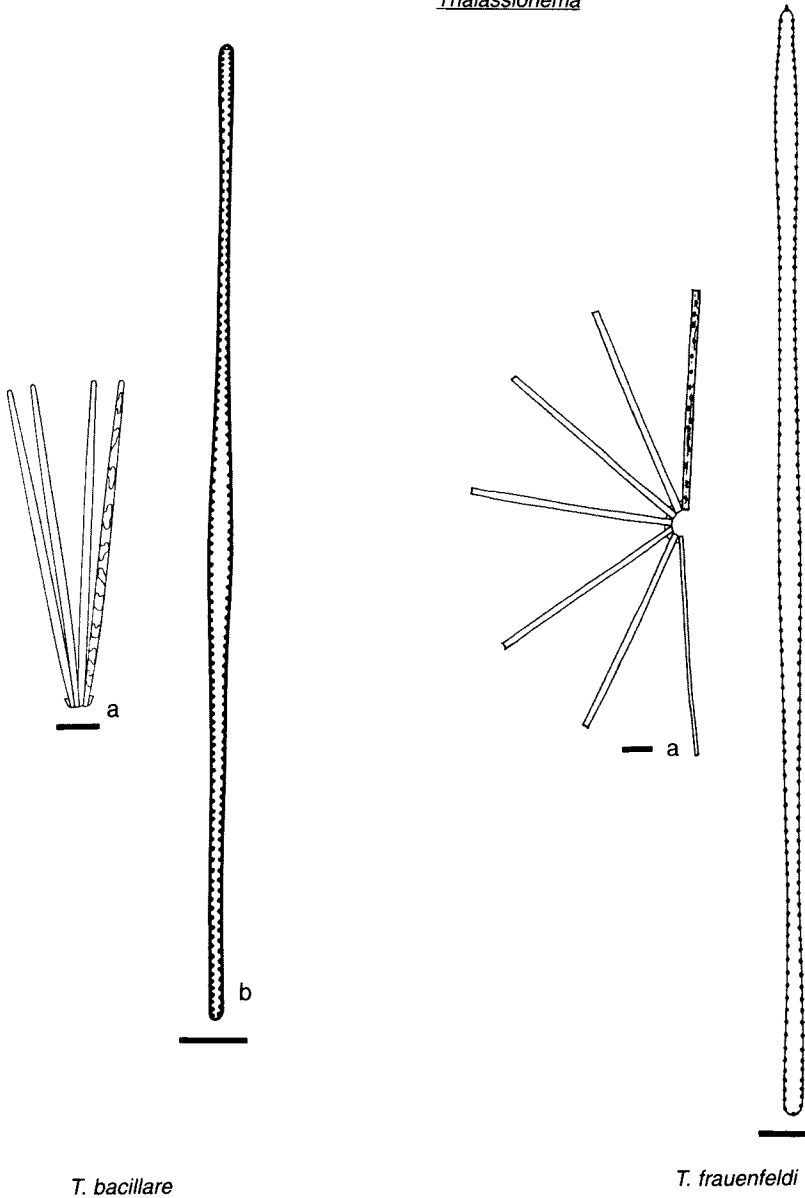

PLATE 55 *Thalassionema bacillare*: (a) colony in valve view. Scale bar = 20  $\mu\text{m}$ ; (b) valve view with marginal structure. Scale bar = 10  $\mu\text{m}$ . *Thalassionema frauenfeldii*: (a) colony in girdle view. After Cupp (1943); Scale bar = 20  $\mu\text{m}$ . (b) valve view with marginal structure and apical spine. Scale bar = 10  $\mu\text{m}$ .

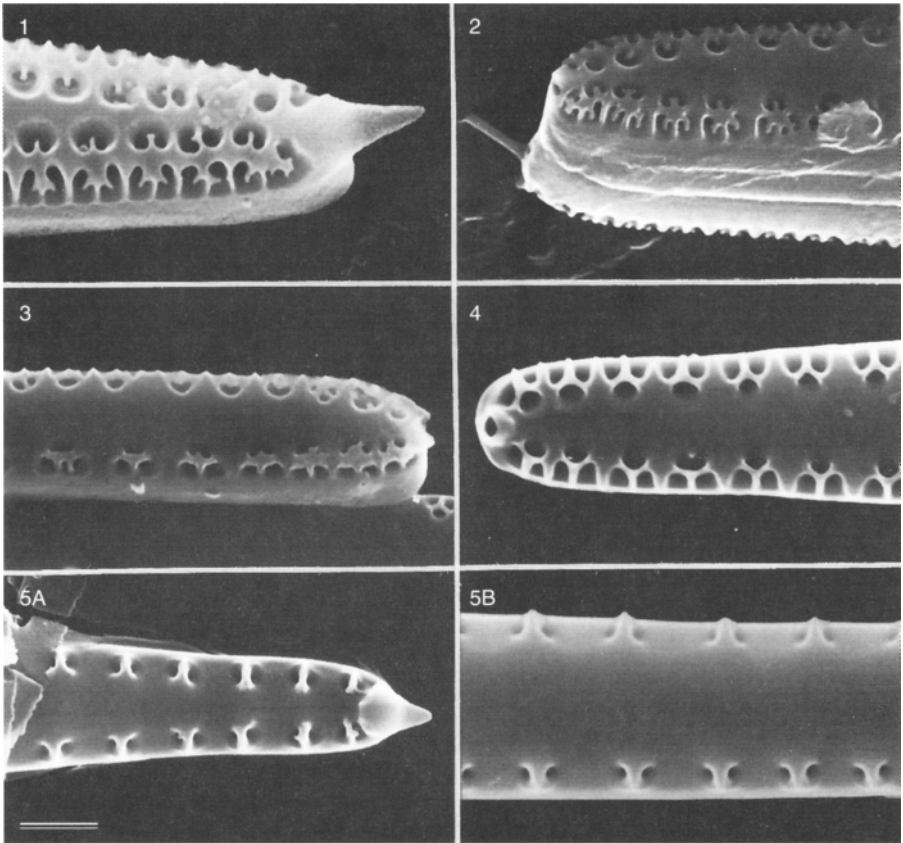

PLATE 56 Scanning electron micrographs. (1) *Thalassionema javanicum*: external view of pointed valve end, apical spine, one marginal row of areolae, and elaborate vela. (2) *Thalassionema nitzschioides*: external view of rounded valve end, wide sternum, one marginal row of areolae, and elaborate vela. (3) *Thalassionema bacillare*: external view of slightly dilated cell end, wide sternum, one marginal row of areolae and elaborate vela. (4) *Thalassionema pseudonitzschioides*: external view of the more narrow valve end, base of apical spine, wide sternum, one marginal row of areolae, and less elaborate vela (reduced?). (5) *Thalassionema frauenfeldii*: external view with one marginal row of areolae crossed by a simple bar; (a) tapering end with apical spine; (b) part of valve with wide sternum. Scale bar = 1  $\mu\text{m}$ .

pp. 91 and 178; Heiden & Kolbe, 1928, p. 564, Plate 6, Fig. 121; Meister, 1932, p. 25, Fig. 52; Cupp, 1943, p. 182, Fig. 133; Kolbe, 1955, p. 178; Hustedt, 1959, pp. 244 and 247, Figs. 725 and 727; Hasle & Mendiola, 1967; Drebes, 1974, p. 103, Fig. 85c; Schuette & Schrader, 1982; Hallegraeff, 1986, pp. 60–65.



*Thalassionema*

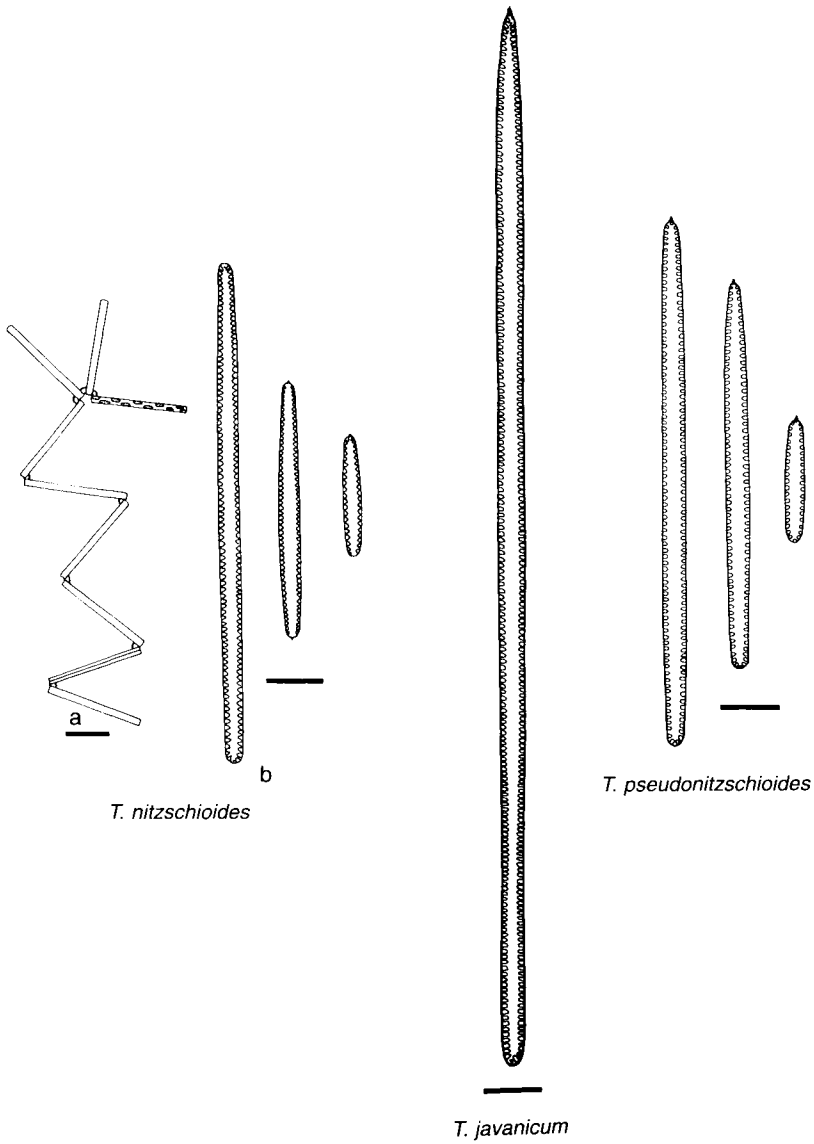

PLATE 57 *Thalassionema nitzschioides*: (a) chain in girdle view. Scale bar = 20  $\mu\text{m}$ ; (b) valves showing size variation and marginal areolae. Scale bar = 10  $\mu\text{m}$ . *Thalassionema javanicum*: valve with apical spine and areola. Scale bar = 10  $\mu\text{m}$ . *Thalassionema pseudonitzschioides*: valves, showing size variation, apical spine, and marginal areolae. Scale bar = 10  $\mu\text{m}$ .

TABLE 66 Morphometric Data of *Thalassionema* spp.

Species	Pervalvar axis ( $\mu\text{m}$ )	Apical axis ( $\mu\text{m}$ )	Transapical axis ( $\mu\text{m}$ )	Areolae in 10 $\mu\text{m}$
<i>T. bacillare</i>	2–3	97–230	1.3–4 <sup>a</sup>	7–8 <sup>b</sup>
<i>T. frauenfeldii</i>	— <sup>d</sup>	54–200	2–4	5–9
<i>T. javanicum</i>	—	142–180	1.2–4	10–12
<i>T. nitzschioides</i>	—	10–110 <sup>c</sup>	2–4	10–12
<i>T. pseudonitzschioides</i>	1–2	10–200	2–4	10–12

<sup>a</sup> 3–4  $\mu\text{m}$  in the middle of the valve, 1.7–2.7  $\mu\text{m}$  at the ends, 1.3–2.0  $\mu\text{m}$  in the narrow parts close to the valve ends (Hasle & Mendiola, 1967); Hallegraeff (1986) gives 400  $\mu\text{m}$  as the maximum length and 5.5–10 areolae in 10  $\mu\text{m}$ .

<sup>b</sup> Greater number closer to the apices.

<sup>c</sup> The maximum length is after Hustedt (1959); Hasle & Mendiola (1967) measured 10–70  $\mu\text{m}$ .

<sup>d</sup> —, No data.

#### Generic characters:

Cells in girdle view rectangular.

Cells isopolar or heteropolar.

Cells in valve view varying from smoothly dilated in the center (acicular, spindle shaped) to linear, or distinctly dilated in the center and at the apices, or one apex rounded and the other slightly tapering.

Sternum wide.

One marginal row of areolae.

Areolae circular.

Internal openings (foramina) of the areolae smaller than the external openings (SEM).

External openings of areolae crossed by a simple silicified bar (strut) or a pattern of crossing bars (struts; Plate 56; SEM). The simple bar is usually coarse and may be discerned with LM, whereas the more complicated pattern is delicate and is only occasionally and partly discernible with LM.

#### KEY TO SPECIES

- 1a. Valve ends dissimilar in width and/or shape. . . . . 2
- 1b. Valve ends similar in width and shape . . . . . 3

- 2a. Valve margins generally straight or slightly convex. Valve width approximately the same along the whole valve length except near the apices . . . . . 4
- 2b. Whole valve almost narrowly clavate: one end acutely club shaped, the other end pointed and ending in a spine. Valve narrow near the club-shaped end, wider in the middle and close to the tapering apex. Marginal structure visible with LM as short ribs between less silicified interspaces . . . . *T. javanicum*<sup>22</sup> (Grunow in Van Heurck) Hasle comb. nov.
- 3a. Valves linear to narrowly lanceolate in outline, presence of apical spine variable, marginal structure visible with LM as ribs . . . . .  
. . . . . *T. nitzschioides* (Grunow) Mereschkowsky
- 3b. Valves more or less expanded in the middle and less often at the ends, areolae visible with LM as circular or subcircular holes, a structure sometimes visible within the holes . . . . .  
. . . . . *T. bacillare*<sup>22</sup> (Heiden in Heiden & Kolbe) Kolbe
- 4a. Valves linear in outline, one end more or less tapering and usually with a spine, the other end broader, rounded, and sometimes slightly expanded, areolae crossed by a simple strongly silicified bar, discernible with LM . . . . . *T. frauenfeldii*<sup>22</sup> (Grunow) Hallegraeff
- 4b. Valves linear in outline except for the one tapering end, usually with a spine, both apices smoothly rounded, marginal structure visible with LM as short ribs . . . . .  
. . . . . *T. pseudonitzschioides*<sup>22</sup> (Schuette & Schrader) Hasle comb. nov.

**Distribution:**

*T. bacillare*—warm water region.

*T. frauenfeldii*—warm water region to temperate.

*T. javanicum*—warm water region to temperate.

*T. nitzschioides*—cosmopolitan but not in the high Arctic and Antarctic.

*T. pseudonitzschioides*—warm water region?

**Remarks:** *Thalassiothrix pseudonitzschioides* was said to differ from *T. nitzschioides* “by having heteropolar apices” (Schuette & Schrader, 1982). Hallegraeff (1986) regarded the two species as conspecific, probably interpreting the heteropolarity as the presence of one apical spine per valve.

<sup>22</sup> Basionyms: *Thalassiothrix frauenfeldii* var. *javanica* Grunow in Van Heurck, *Spinigera bacillaris* Heiden in Heiden & Kolbe; *Asterionella frauenfeldii* Grunow and *Thalassiothrix pseudonitzschioides* Schuette & Schrader, respectively. Synonym: *Thalassiothrix (frauenfeldii [sic!]) javanica* (Grunow) Cleve and *Thalassiothrix frauenfeldii* (Grunow) Grunow in Cleve & Grunow, respectively.

Based on the areola structure *T. pseudonitzschioides* certainly belongs to *Thalassionema*. The valve outline with one apex more pointed and the other more rounded exhibits only inconsiderable variation from the smallest to the largest specimens (Schuette & Schrader, 1982; G. Hasle and E. Syvertsen, personal observations), and distinguishes *T. pseudonitzschioides* as a separate species. Grunow's drawings of *T. frauenfeldii* and *T. javanicum* (Van Heurck, 1880–1885, Plate 37, Figs. 12 and 13) point out the difference in the marginal structure which refers to the density of areolae as well as the velum structure seen with EM. There is a certain possibility that *Asterionella synedraeformis* (Greville, 1865a) is an earlier synonym of *T. frauenfeldii* var. *javanica*. The variety was raised in rank by Cleve (1990c) which antedates *T. javanica* Hustedt in Meister, 1932 (see VanLandingham, 1967–1979, p. 4001). It should be noted that, in agreement with Hallegraeff (1986), weight here has been put on the presence and absence of marginal spines and the areola structure and not on the polarity of cells as the distinction between *Thalassiothrix* and *Thalassionema*.

**Genus *Thalassiothrix*** Cleve & Grunow 1880 (Plates 58 and 59, Table 67)

**Type:** *Thalassiothrix longissima* Cleve & Grunow (conservation proposed by Silva & Hasle, 1993).

**Synonym:** *Synedra thalassiothrix* Cleve [“*Thalassiothrix*”].

**References:** Cleve, 1873b, p. 22, Plate 4, Fig. 24; Cleve & Grunow, 1880, p. 108; Karsten, 1905, p. 124, Plate 17, Fig. 12; Cupp, 1943, p. 184, Fig. 134; Hustedt, 1959, p. 247, Fig. 726; Hasle, 1960, p. 19, Fig. 6, Plate 5, Figs. 46–48; Hallegraeff, 1986, pp. 64 and 66–69; Hasle & Semina, 1987; Silva & Hasle, 1993.

Generic characters:

Cells solitary or in radiating colonies.

Cells straight or slightly curved or sigmoid.

Cells usually strongly twisted.

Cells isopolar or heteropolar.

Valves more or less inflated in the middle and near the apices.

Sternum wide and sometimes narrower near the apices.

One marginal row of areolae.

External openings of areolae elongate, with LM appearing as short marginal striae.

Internal openings (foramina) of areolae smaller than the external openings (Plate 59, Fig. 1a; SEM).

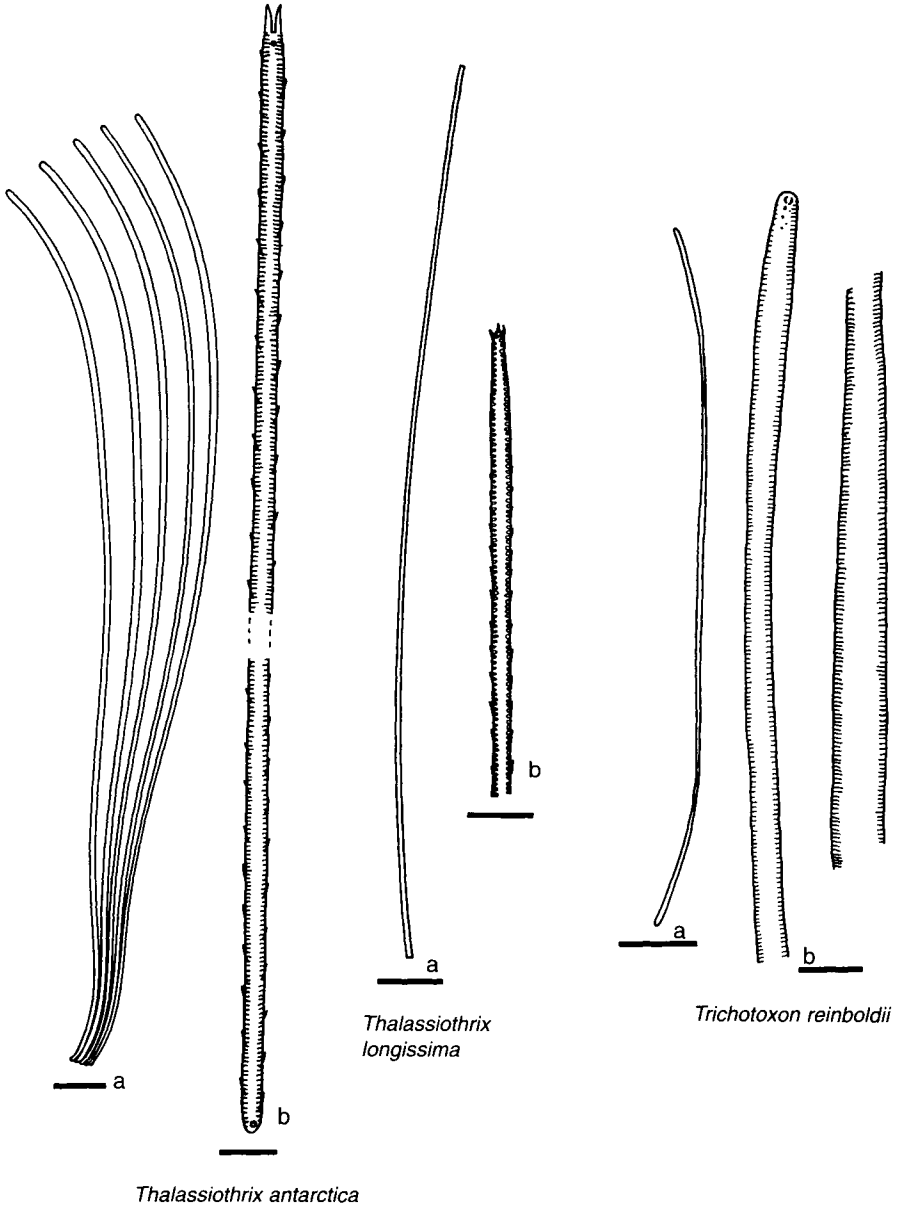
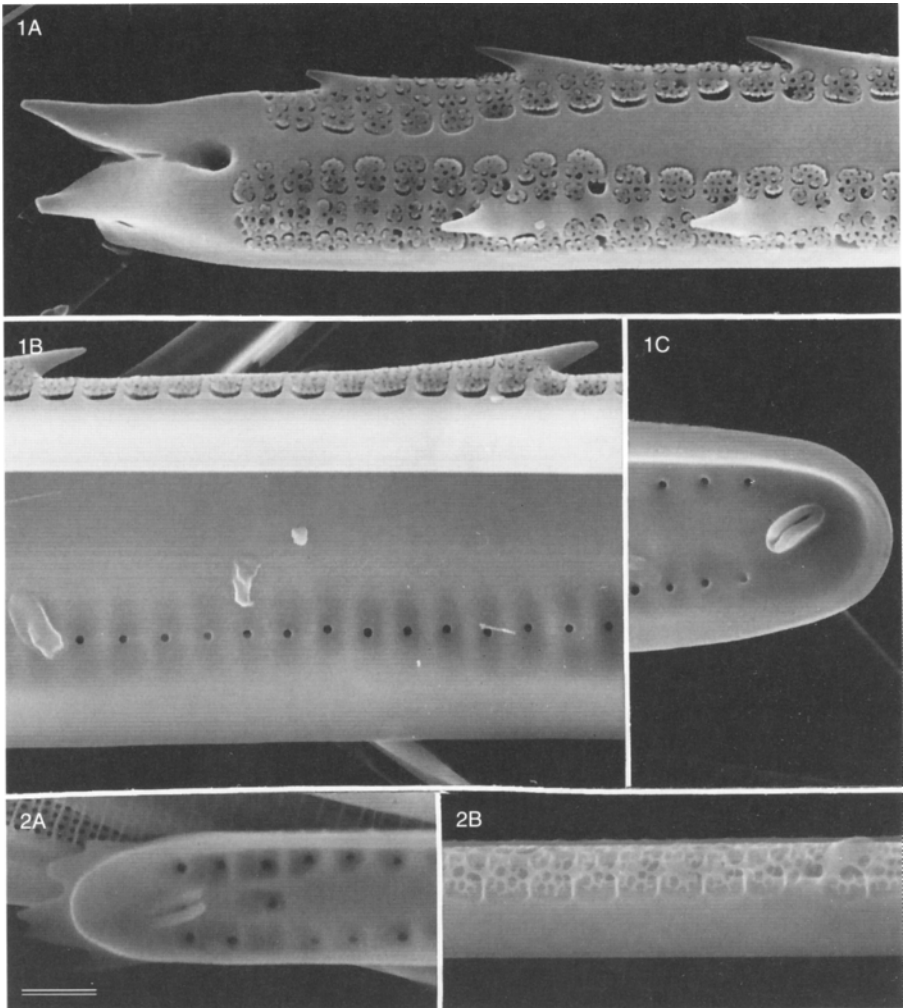

PLATE 58 *Thalassiothrix antarctica*: (a) colony in girdle view. Scale bar = 100  $\mu\text{m}$ ; (b) valve showing foot and head poles, marginal spines, and areolation. After Heiden & Kolbe (1928). Scale bar = 10  $\mu\text{m}$ . *Thalassiothrix longissima*: (a) single cell. Scale bar = 100  $\mu\text{m}$ ; (b) valve end. Scale bar = 10  $\mu\text{m}$ . After Hustedt (1959). *Trichotoxon reinboldii*: (a) whole cell. After Van Heurck (1909). Scale bar = 100  $\mu\text{m}$ ; (b) parts of valve with marginal structure. Scale bar = 10  $\mu\text{m}$ .



**PLATE 59** Scanning electron micrographs. (1) *Thalassiothrix antarctica*: (a) external view, head pole with two heavy apical spines, external opening of labiate process, and marginal spines in the middle of the vela; (b) partial internal view, one marginal row of small foramina, and marginal spines; (c) internal view of rounded, spineless foot pole with labiate process. (2) *Thalassiothrix longissima*: (a) internal view, valve end with serrated protrusions, and labiate process; (b) external side view showing vela and one marginal spine below the vela. Scale bar = 1  $\mu\text{m}$ .

External openings of areolae covered by reticulate vela (SEM) divided more or less distinctly into two compartments by a longitudinal bar running parallel to valve margins just discernible with LM.

TABLE 67 Morphometric Data of *Thalassiothrix* spp.

Species	Apical axis (μm)	Transapical axis (μm)	Areolae in 10 μm	Marginal spines in 10 μm
<i>T. antarctica</i>	420–5680	1.5–6	12–17	1–2
<i>T. gibberula</i>	365–1022	2–8	13–16	2–3
<i>T. longissima</i>	530–4000	2.5–6	11–16	1–3

Marginal spines located in the middle of the vela on the longitudinal bars (LM) or on the border between the vela and the unperforate margin of the valve mantle (Plate 59, Figs. 1a and 2b).

KEY TO SPECIES

- 1a. Cells heteropolar, one end with two winged spines, the other with no spines, smoothly rounded marginal spines in the middle of the vela. . . . . 2
- 1b. Cells isopolar, either end with serrated protrusions, solitary, slightly curved, marginal spines at the lower edge of the vela. . . . .  
 . . . . . *T. longissima* Cleve & Grunow
- 2a. Cells in radiating colonies, joined by bent foot poles and a shorter or longer part of the cell length, sigmoid in girdle view . . . . .  
 . . . . . *T. antarctica* Schimper ex Karsten
- 2b. Cells solitary, usually straight, inflated in the middle. . . . .  
 . . . . . *T. gibberula* Hasle

Distribution:

- T. antarctica*—southern cold water region.
- T. gibberula*—warm water region.
- T. longissima*—northern cold water region to temperate.

**Remarks:** The colony-forming *T. antarctica* is readily recognized in water mount by the bent foot pole, and *T. longissima*, is recognized by the smooth curvature of the cell. As cleaned valves in permanent mounts *T. longissima* and *T. antarctica* are distinguished by the shape of the valve ends and the difference in location of the marginal spines (Hasle & Semina, 1987, Figs. 2–12, *T. longissima*; Figs. 34–43, *T. antarctica*). The heteropolarity and the location of the marginal spines in the middle of the vela make *T. gibberula* morphologically closer to *T. antarctica* than to *T. longissima*. The apparent lack of colony formation, the straight cells, and the inflation in the middle (Hasle, 1960, Fig. 6) characterize *T. gibberula*. The sternum of *T. lanceolata* Hustedt is narrower and the marginal spines are more widely spaced than those in *T. gibberula* (Simonsen, 1987, Plate 667, Figs. 7–11). A warm water species under description (Hasle, manuscript in preparation) differs

from the *Thalassiothrix* species mentioned by the shape of the foot pole. *Thalassiothrix gibberula* was described from water samples of the equatorial Pacific (Hasle, 1960). The description was accompanied by a figure and a Latin diagnosis but no holotype was indicated (see Taxonomic Appendix).

**Genus *Trichotoxon*** F. M. Reid & F. E. Round 1988 (Plate 58)

**Type:** *Trichotoxon reinboldii* (Van Heurck) Reid & Round.

Monospecific genus.

***Trichotoxon reinboldii*** (Van Heurck) Reid & Round

**Basionym:** *Synedra reinboldii* Van Heurck.

**Synonym:** *Synedra pelagica* Hendeby.

**References:** Van Heurck, 1909, p. 23, Plate 3, Fig. 35; Hendeby, 1937, p. 335; Hasle & Semina, 1988, p. 189, Figs. 67–75; Reid & Round, 1988.

Cells solitary or in pointed, ovoid colonies formed by cells attached at either end. Cells bow shaped and not twisted. Valves expanded in central part and less at the ends. Cell ends isopolar with no apical spines. No marginal spines. Internal openings of areolae much smaller than the external openings (SEM). External vela reticulate.

**Morphometric data:** Apical axis, 800–3500  $\mu\text{m}$ ; transapical axis of mid-section, 5–8  $\mu\text{m}$ , and of the ends, 3.5–6.6  $\mu\text{m}$  (Reid & Round, 1987).

**Distribution:** Southern cold water region.

**How to identify:** Diatoms of the family Thalassionemataceae in intact colonies, occasionally also as single whole cells, may be identified in water mounts. Permanent mounts of material cleaned of organic matter may be needed in critical cases, e.g., to distinguish between *T. bacillare* and *T. frauenfeldii*.

**Suborder Bacillariineae**—Raphid pennate diatoms

Terminology specific to raphid pennate diatoms (Mann, 1978; Ross et al., 1979; Round et al., 1990): (Fig. 18)

**Raphe system**—one or two longitudinal slits through the valve wall.

**Central raphe ending**—central end of the raphe slit when the raphe system consists of two slits.

**Central pore**—a pore-like expansion of the central raphe ending.

**Central nodule**—bridge of silica separating the two raphe slits, often thicker than the rest of the valve.

**Stauros**—a central nodule that is expanded transapically and reaches or almost reaches the margin of the valve.

**Terminal nodule**—a thickening at the apical end of a raphe.

**Helictoglossa**—an inwardly projecting lipped structure terminating the raphe on the inner side of the valve.



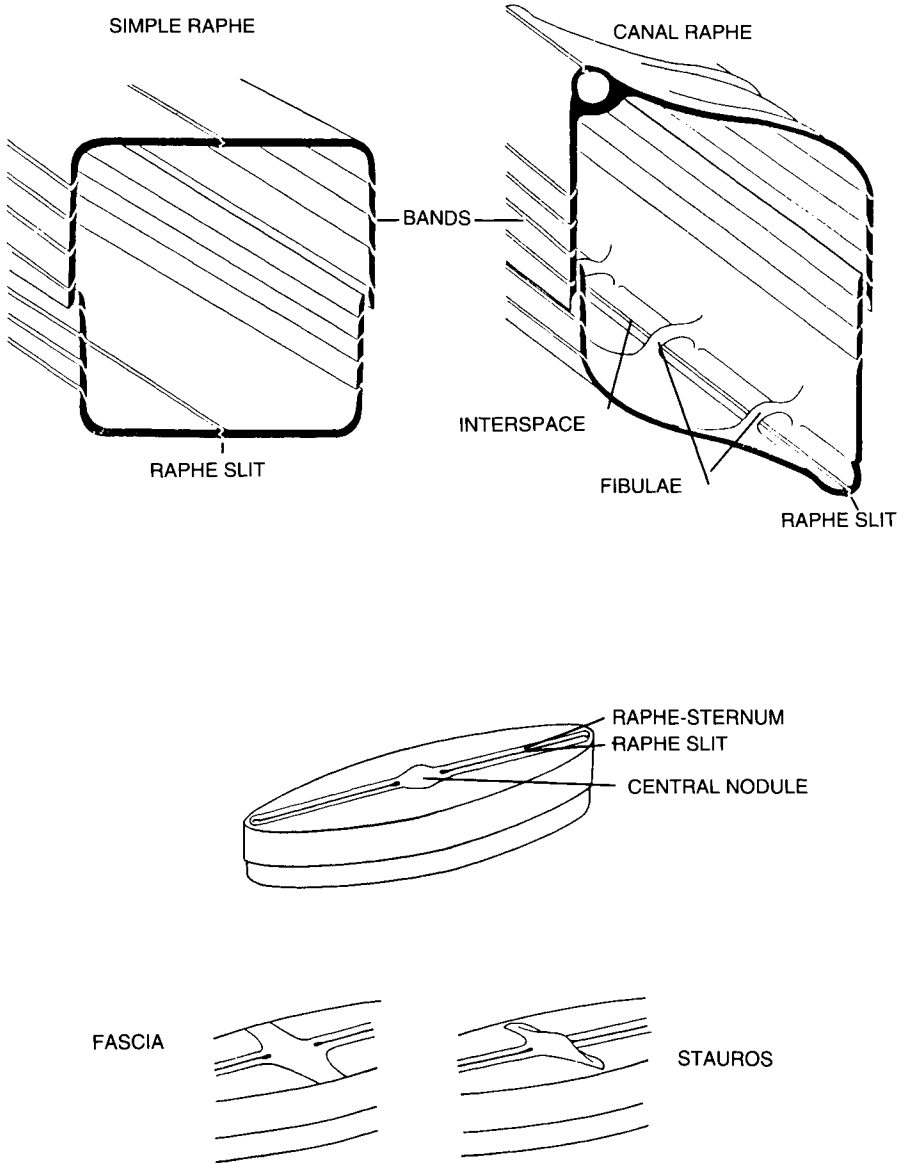

FIGURE 18 Schematic illustration of simple and canal raphes with terminology.

**Raphe**—sternum—the usually unperforate strip of silica, often thickened perivalvarly, which contains the raphe (Mann, 1978, p. 27).

#### Family Achnantheaceae Kützing 1844

Diatoms of this family have heterovalvar cells. One of the valves has a raphe with two longitudinal slits. The other valve has no raphe or only short slits, with the raphe being filled out by silica during the formation of the new valves (Round et al., 1990, p. 33). The cells are more or less genuflexed in the transapical axis. *Achnanthes taeniata* belongs to Arctic and Baltic Sea plankton, evidently as the only truly planktonic species of this family.

*Achnanthes taeniata* Grunow in Cleve & Grunow (Plate 60)

**References:** Cleve & Grunow, 1880, p. 22, Plate 1, Fig. 5; Hustedt, 1959, p. 382, Fig. 828; Hasle & Syvertsen, 1990b, p. 289, Figs. 12–22.

**Girdle view:** Cells only slightly genuflexed, raphe valve on the inside of the curvature. Cells in ribbons; vegetative cells attached along entire valve face; apices of resting spores in chains not attached. One (?) H-shaped chloroplast along the girdle.

**Valve view:** Valve linear with rounded apices. Raphe straight, sternum narrow.

**Morphometric data:** Apical axis, 10–40  $\mu\text{m}$ ; transapical axis, 4–6  $\mu\text{m}$ ; transapical striae, ca. 25 in 10  $\mu\text{m}$ .

**Distribution:** Northern cold water region and the Baltic Sea.

**How to identify:** *Achnanthes taeniata* may easily be confused with *Fragilariopsis* species and with *Navicula* and *Nitzschia* species-forming ribbons. In some cases the shape of the chains is distinctive but in most cases all these diatoms must be examined in valve view, preferably in permanent mounts of cleaned material.

#### Family Phaeodactylaceae J. Lewin 1958

Genus *Phaeodactylum* Bohlin 1897

**Type:** *Phaeodactylum tricornutum* Bohlin.  
Monospecific genus.

*Phaeodactylum tricornutum* Bohlin (Plate 60)

**Synonym:** *Nitzschia closterium* W. Smith f. *minutissima* Allen & Nelson.

**References:** Bohlin, 1897, pp. 519 and 520, Fig. 9; Allen & Nelson, 1910, p. 426; Wilson, 1946; Hendey, 1954; Lewin, 1958; Round et al., 1990, p. 560; Gutenbrunner et al., 1994, p. 129, Figs. 2–5.

Solitary. Three types of cells: ovate (naviculoid), fusiform, and, more rarely, triradiate. Ovate cells motile with one siliceous valve per cell.

Fusiform cells nonmotile and lack a siliceous valve. One chloroplast.

**Morphometric data:** Ovate cells 8  $\mu\text{m}$  in apical axis, 3  $\mu\text{m}$  in transapical axis; striae not resolved with LM; fusiform cells up to 25–35  $\mu\text{m}$  long.

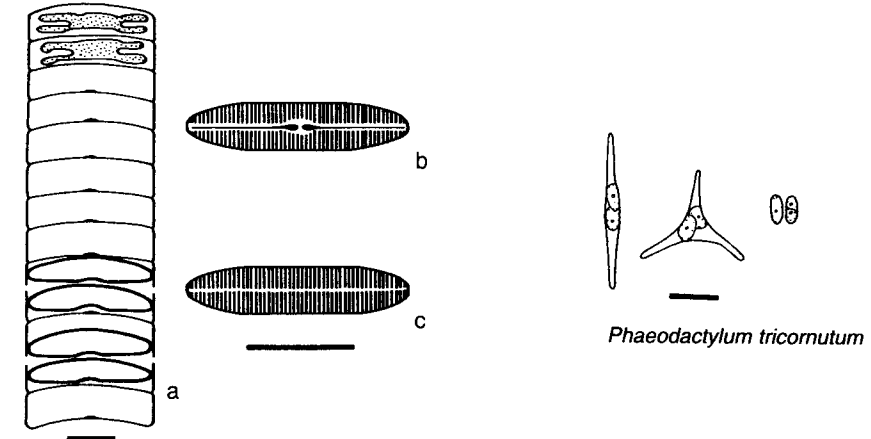

*Achnanthes taeniata*

*Phaeodactylum tricorutum*

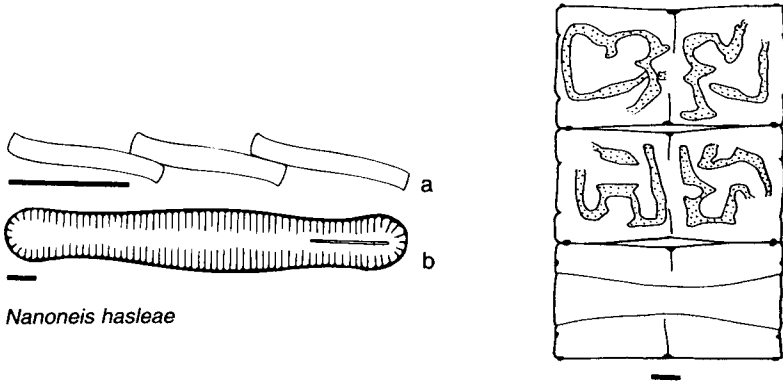

*Nanoneis hasleae*

*Meuniera membranacea*

PLATE 60 *Achnanthes taeniata*: (a) chain with resting spores and chloroplasts; (b) valve with raphe; (c) rapheless valve. Scale bars = 10  $\mu\text{m}$ . *Phaeodactylum tricorutum*: Three cell types. After Wilson (1946). Scale bar = 10  $\mu\text{m}$ . *Nanoneis hasleae*: (a) stepped chain in girdle view. Scale bar = 10  $\mu\text{m}$ ; (b) valve view. Scale bar = 1  $\mu\text{m}$ . *Meuniera membranacea*: short chain in girdle view with chloroplasts. After Sournia (1968) and Gran (1908). Scale bar = 10  $\mu\text{m}$ .

**Distribution:** Intertidal rock pools—probably cosmopolitan.

**How to identify:** Siliceous valves, recognized only by the raphe, are found in cleaned material mounted in a medium of a high refractive index.

Phase or interference contrast will most likely be needed. The presence of nonsiliceous cells can be verified by “elimination” methods since they will

disappear in acid-cleaned material or, sometimes be seen with LM as an unstructured cell wall.

**Remarks:** The fusiform cell type was, in the past, frequently confused with the pennate diatom *N. closterium* (= *Cylindrotheca closterium*), e.g., the Plymouth strain "*Nitzschia closterium* f. *minutissima*." This strain was used for decades in diatom physiology studies until a microscopical examination showed that it was the fusiform *Phaeodactylum tricornutum*.

*Incertae sedis* (Raphid diatoms)

**Genus** *Nanoneis* R. E. Norris 1973

**Type:** *Nanoneis hasleae* R. E. Norris.

Monospecific genus.

*Nanoneis hasleae* R. E. Norris (Plate 60)

**Reference:** Norris, 1973.

**Girdle view:** Valve surfaces slightly convex to flat or concave, with the concavity present between the apices and the middle part of the valve.

Cells occurring in irregular chains with a short overlap of cell ends.

**Valve view:** Broadly elliptical to linear. Valve structure not resolved with LM. Raphe central and extending from one pole to near center; raphe of opposite valve extending from the opposite pole to near center.

**Morphometric data:** Apical axis, 5–12  $\mu\text{m}$ ; transapical axis, 1–1.5  $\mu\text{m}$ ; transapical interstriae, ca. 40 in 10  $\mu\text{m}$  (TEM).

**Distribution:** Warm water region—open ocean.

**How to identify:** Electron microscopy may be needed.

**Family Naviculaceae** Kützing 1844

The genera treated here under the family name Naviculaceae have been placed in a variety of families in the classification systems by Glezer et al. (1988) and Round et al. (1990). In a manual to be used for species identification, like this chapter, we prefer Simonsen's (1979) broader delineation of Naviculaceae. Naviculaceae differs from Achnanthaceae and Phaeodactylaceae by being isovalvar; both valves of a cell have a "naviculoid" raphe not subtended by the fibulae present in Bacillariaceae.

*Navicula* is the largest of all diatom genera with 1860 "acceptable" and 2000 "unacceptable species," mainly bottom living forms (Mann, 1986, p. 216). Many of the few marine planktonic *Navicula* species were transferred to other genera, especially after Cox (1979) typified and emended the description of *Navicula sensu stricto*.

*Tropidoneis* is another genus under revision. Patrick & Reimer (1975) found that the name *Tropidoneis* had to be rejected in favor of *Plagiotropis*. *Plagiotropis* has about 30 species (Paddock, 1990) and is the largest of the

genera to which the former *Tropidoneis* species have been transferred. It comprises brackish water and marine, mostly bottom living species.

*Pachyneis* with one planktonic tropical and subtropical species was suggested as a possible transition form between *Haslea*, the former *Navicula fusiformes sensu* Hustedt, 1961, and some planktonic *Tropidoneis* species (Simonsen, 1974). *Pleurosigma* includes marine species, some of which are planktonic.

For practical reasons the genera here referred to as Naviculaceae are divided into four groups.

- A. Former and present *Navicula* species.
  1. Former *Navicula* sp. in ribbons: *Meuniera membranacea*.
  2. Present *Navicula* spp. in ribbons: *N. granii*, *N. pelagica*, *N. septentrionalis*, and *N. vanhoeffenii* (Table 68).
  3. Former solitary *Navicula* spp.: *Haslea* spp. (Table 69).
  4. Present solitary *Navicula* spp.: *N. directa*, *N. distans*, *N. transitans* var. *derasa*, and *N. transitans* var. *derasa* f. *delicatula* (Table 70).
- B. *Pleurosigma* spp.: *P. directum*, *P. normanii*, and *P. simonsenii* (Table 71).
- C. The *Tropidoneis* group.
  1. Former *Navicula* sp., usually solitary: *Ephemera planamembranacea*.
  2. Former *Tropidoneis* spp., usually in ribbons.
    - a. Valves lying in girdle view, vaulted to a high ridge: *Banquisia* and *Membraneis* (Table 72).
    - b. Valves lying in girdle or valve view; valve with only low ridge: *Manguinea* and *Plagiotropis* (Table 72).
- D. *Incertae sedis* (Naviculaceae): *Pachyneis*.

- A. Former and present *Navicula* species.

Common characters:

Valves linear, lanceolate, or elliptical.

Raphe generally straight.

Raphe not raised on a ridge.

Stauros or stauros-like structure present in some species.

Characters showing differences between species:

The presence or absence of chains.

Number and shape of chloroplasts.

Valve striation pattern.

Extension of stauros or stauros like structure.

The presence or absence of raphe fins.

1. Former *Navicula* species in ribbons.

**Genus** *Meuniera* P. C. Silva nom. nov.

**Type:** *Meuniera membranacea* (Cleve) P. C. Silva comb. nov.

Monospecific genus.

***Meuniera membranacea*** (Cleve) P. C. Silva comb. nov. (Plate 60)

**Basionym:** *Navicula (Stauroneis) membranacea* Cleve.

**Synonyms:** *Stauropsis membranacea* (Cleve) Meunier; *Stauroneis membranacea* (Cleve) Hustedt.

**References:** Cleve, 1897a, p. 24, Plate 2, Figs. 25–28; Meunier, 1910, p. 319, Plate 33, Figs. 37–40; Cupp, 1943, p. 193, Fig. 142; Hustedt, 1959, p. 833, Fig. 1176; Hendeby, 1964, p. 221, Plate 21, Fig. 3; Paddock, 1986, p. 89, Figs. 1–8.

**Girdle view:** Rectangular, valves flat or slightly concave in the center. Cell wall weakly silicified. Stauros narrow and distinct in girdle view. Raphe fins at corners of cells in girdle view (LM). Four ribbon-like and folded chloroplasts per cell, two along each side of the girdle.

**Valve view:** Valves narrow and elliptical with pointed ends. Structure barely visible with LM. Stauros extending from the central nodule to valve margin.

**Morphometric data:** Pervalvar axis, 30–40  $\mu\text{m}$ ; apical axis, 50–90  $\mu\text{m}$ .

**Distribution:** Temperate.

**How to identify:** *Meuniera membranacea* is readily recognized with LM in girdle view by the distinct stauros and the typical chloroplasts.

**Remarks:** *Stauropsis* Reichenbach 1860 had been used for an orchid genus; therefore, the diatom genus had to be given a new name (see Taxonomic Appendix).

2. Present *Navicula* spp. in ribbons (Plate 61, Table 68).

Meunier (1910) regarded the following four marine, mainly planktonic species to belong to the genus he described as *Stauropsis*. Paddock (1986) disagreed after having reviewed them on the basis of LM and EM data. Characters showing differences between the species are evident from the key and the illustrations.

**References:** Grunow, 1884, p. 105, Plate 1, Fig. 48; Cleve, 1896a, p. 11, Plate 1, Fig. 9; Gran, 1897a, p. 21, Plate 1, Figs. 1–3; Jørgensen, 1905, p. 107, Plate 7, Fig. 25; Gran, 1908, p. 123, Figs. 167–170; Meunier, 1910, p. 321, Plate 33, Figs. 26, 27, and 33–36; Cleve-Euler, 1952, p. 25, Fig. 1381; Heimdal, 1970, Figs. 1–11; Syvertsen, 1984; Hasle & Syvertsen, 1990b, p. 288, Figs. 1–4.

*Navicula*

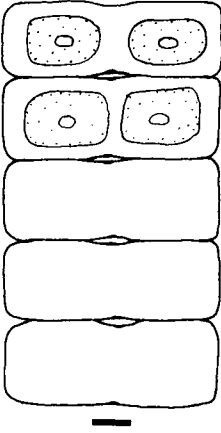

*N. granii*

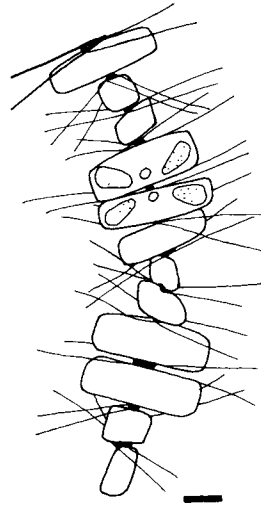

*N. pelagica*

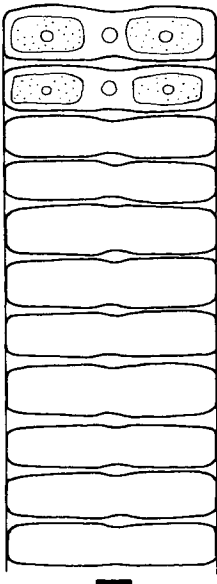

*N. vanhoeffenii*

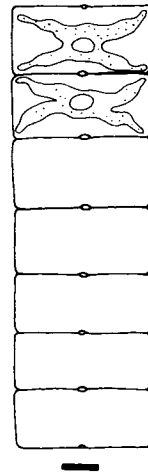

*N. septentrionalis*

TABLE 68 Morphometric Data of *Navicula* spp. in Ribbons

Species	Pervalvar axis (μm)	Apical axis (μm)	Transapical axis (μm)	Striae in 10 μm
<i>N. granii</i>	— <sup>a</sup>	50–57	—	—
<i>N. pelagica</i>	5–9	10–50	6–7	50–56 <sup>b</sup>
<i>N. septentrionalis</i>	—	20–30	—	—
<i>N. vanhoeffenii</i>	—	13–65	4–5	54–63 <sup>b</sup>

<sup>a</sup> —, No data.

<sup>b</sup> Measured in TEM.

KEY TO SPECIES

- 1a. Cells in ribbons partly or not in touch . . . . . 2
- 1b. Cells in tight ribbons . . . . . 3
- 2a. Cells united by a mucilage pad in the central nodule area with threads (“setae”) attached, two comma- or pear-shaped chloroplasts per cell . . . . . *N. pelagica* Cleve
- 2b. Cells in colonies widely separated, two plate-like chloroplasts per cell . . . . . *N. vanhoeffenii* Gran
- 3a. Cells united by the entire valve faces, one chloroplast per cell, with four arms and large central pyrenoid . . . . . *N. septentrionalis* (Grunow) Gran
- 3b. Cells not touching at apices and in the center, two rectangular chloroplasts per cell, each with large central pyrenoid . . . . . *N. granii* (Jørgensen) Gran

**Basionyms:** *Stauroneis septentrionalis* Grunow; *Stauroneis granii* Jørgensen.

**Synonyms:** *Stauropsis pelagica* (Cleve) Meunier; *Stauropsis vanhoeffenii* (Gran) Meunier; *Stauropsis granii* (Jørgensen) Meunier; and *Navicula quadripedis* Cleve-Euler [regarded by VanLandingham (1975, p. 2796) as the valid name for *Navicula septentrionalis* Gran, 1908 (Fig. 167)].

**Distribution:** Northern cold water region

**How to identify:** These species may be distinguished in chains in water mounts.

**Remarks:** The setae-like structures in *N. pelagica* are dislocated girdle bands (Syvertsen, 1984). *Navicula pelagica* is also distinguished by the

---

PLATE 61 *Navicula granii*: ribbon in girdle view with characteristic chloroplasts. *Navicula pelagica*: twisted chain in girdle view with dislocated bands. *Navicula vanhoeffenii*: ribbon in girdle view, cells not touching, square chloroplasts. *Navicula septentrionalis*: ribbon in girdle view, lens-shaped structure between cells, chloroplasts lobed. Scale bars = 10 μm.



arrangement of cells in chains, which is rotated approximately 50° on the chain axis in relation to its neighboring cell.

3. Former solitary *Navicula* spp.

**Genus *Haslea*** Simonsen 1974

**Type:** *Haslea ostrearia* (Gaillon) Simonsen.

**Basionym:** *Vibrio ostrearius* Gaillon.

**Synonym:** *Navicula ostrearia* Turpin in Bory de St.-Vincent:

**References:** Hustedt, 1961, p. 34 as *Navicula fusiformes*, Simonsen, 1974, p. 46; Cox, 1979.

*Haslea* comprises 13 species (Simonsen, 1974), all of which are marine; some of them are planktonic and some are associated with a substratum, e.g., ice (Poulin, 1990). Three, apparently more commonly recorded planktonic species, distinguished by size, fineness of structure, and distribution, are included here.

Generic characters:

Cells solitary (or in mucilage tubes = benthic forms).

Cell wall weakly silicified.

Cells generally fusiform in girdle and valve views.

Valves narrow and linear to lanceolate, valve ends pointed.

Transverse and longitudinal striae crossed at right angles.

Raphe central pores small and approximate.

Chloroplasts, two plate like (*H. ostrearia*).

Von Stosch (1986) observed many small bacilliform or roundish chloroplasts in *H. gigantea* and two in *H. wawriksae* which in old cultures seemed to divide into numerous small platelets.

***Haslea gigantea*** (Hustedt) Simonsen (Table 69)

**Basionym:** *Navicula gigantea* Hustedt.

TABLE 69 Morphometric Data of *Haslea* spp.

Species	Apical axis (μm)	Transapical axis (μm)	Striae in 10 μm	
			Transverse	Longitudinal
<i>H. gigantea</i>	300–419	32–54	16–17	20–24
<i>H. trompii</i>	70–160	10–14	28–30	17–20
<i>H. wawriksae</i>	286–560	4–6.5	18–21	ca. 40

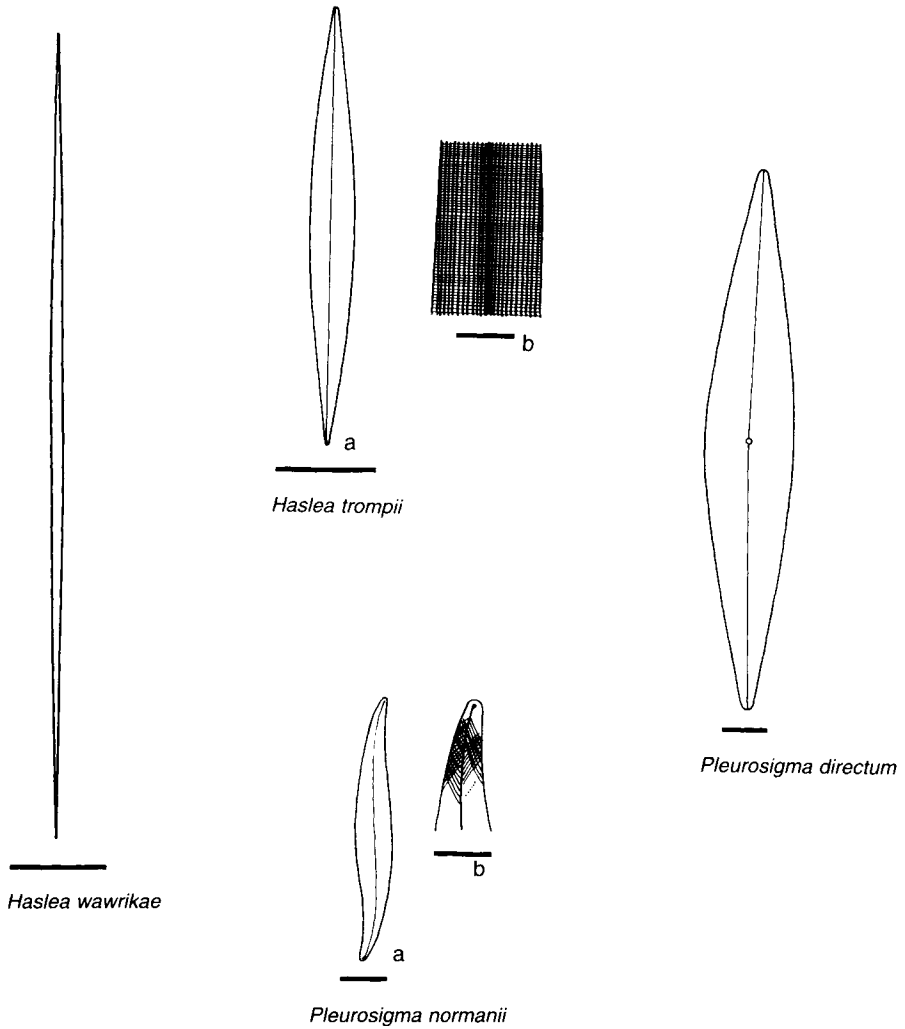

**PLATE 62** *Haslea wawrikae*: valve outline. After Sournia (1968). Scale bar = 50  $\mu\text{m}$ . *Haslea trompii*: (a) valve view. Scale bar = 50  $\mu\text{m}$ ; (b) valve structure. After Hustedt (1961). Scale bar = 10  $\mu\text{m}$ . *Pleurosigma normanii*: (a) valve view. Scale bar = 20  $\mu\text{m}$ ; (b) valve end, structure. After Cupp (1943). Scale bar = 10  $\mu\text{m}$ . *Pleurosigma directum*: valve view. After Peragallo (1891). Scale bar = 20  $\mu\text{m}$ .

**References:** Hustedt, 1961, p. 40, Fig. 1194; Simonsen, 1974, p. 47, Plate 31, Fig. 1; von Stosch, 1986, p. 333, Fig. 20.

Valves lanceolate. Raphe straight, central pores extremely close. No visible sternum. Striation discernible with LM (interference contrast).

***Haslea trompii*** (Cleve) Simonsen (Plate 62, Table 69)

**Basionym:** *Navicula trompii* Cleve.

**References:** Cleve, 1901b, p. 932, Fig. 11; Hustedt, 1961, p. 40, Fig. 1195; Simonsen, 1974, p. 47.

Valves lanceolate. Raphe straight; central pores extremely close. No visible sternum. Longitudinal interstriae more distinct than the transverse ones and readily observed with LM.

***Haslea wawrikae*** (Hustedt) Simonsen (Plate 62, Table 69)

**Basionym:** *Navicula wawrikae* Hustedt.

**References:** Hustedt, 1961, p. 52, Fig. 1204; Simonsen, 1974, p. 48; von Stosch, 1986, p. 339, Fig. 23.

Valves extremely narrow and spindle shaped with long, almost rostrate, ends. Raphe with very long terminal nodules. Transapical striae discernible with LM (phase or interference contrast).

The pervalvar axis of *H. wawrikae* is 4–7  $\mu\text{m}$  and that of *H. gigantea* is 30–70  $\mu\text{m}$ , whereas *H. gigantea* var. *tenuis* is smaller in all dimensions (von Stosch, 1986).

**Distribution:**

*H. gigantea* and *H. wawrikae*—warm water region.

*H. trompii*—southern cold water region.

**How to identify:** *Haslea wawrikae* may be identified by the narrowness of the cells. The valve striation may be seen by using dry mounts [cells or single valves mounted in air (von Stosch, 1986)] or on valves mounted in a medium of a high refractive index.

#### 4. Present solitary *Navicula* spp.

Most of the solitary *Navicula* species found in marine plankton have been stirred up from the bottom or detached from some type of substrate. *Navicula transitans* var. *derasa* is common on Arctic sea ice (Poulin, 1990) but is also found in the plankton. The form *delicatula*, described by Heimdal (1970) from a fjord in northern Norway, is common in Norwegian coastal waters in general. *Navicula directa* and *N. distans* are primarily bottom dwelling species but are often found in the plankton (Gran & Angst, 1931; Hendey, 1964).

---

**PLATE 63** *Navicula directa*: (a) valve with chloroplasts; (b) valve structure. After Gran & Angst (1931). *Navicula distans*: (a) valve with chloroplasts; (b) valve structure. After Gran & Angst (1931). *Navicula transitans*: (a) var. *derasa*, valve with chloroplasts. After Heimdal (1970); (b) var. *derasa*, valve structure. After Cleve & Grunow (1880); (c) f. *delicatula*, valve with typical chloroplasts. After Heimdal (1970). Scale bars = 10  $\mu\text{m}$ .

*Navicula* - valve view

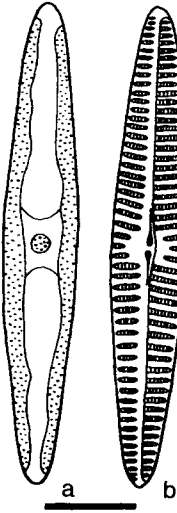

*N. directa*

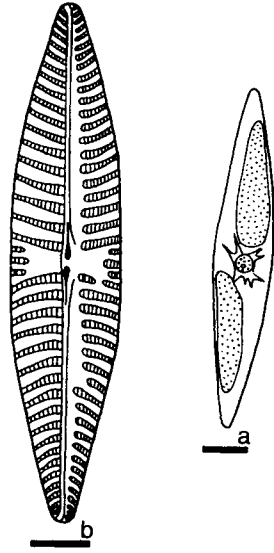

*N. distans*

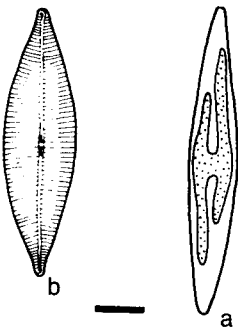

*N. transitans* var. *derasa*

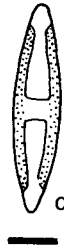

f. *delicatula*

TABLE 70 Morphometric Data of Solitary *Navicula* spp.

Species	Apical axis ( $\mu\text{m}$ )	Transapical axis ( $\mu\text{m}$ )	Striae in 10 $\mu\text{m}$	
			Transverse	Longitudinal
<i>N. directa</i>	53–120	7–12	7–11	30–33
<i>N. distans</i>	70–130	14–20	5–6	— <sup>a</sup>
<i>N. transitans</i>				
var. <i>derasa</i>	42–96	9–21	8.5–12; 10–16 <sup>b</sup>	24–30
f. <i>delicatula</i>	32–49	7–9	15–16	24–30

<sup>a</sup> —, No data.

<sup>b</sup> The higher numbers are found near the valve ends.

Common characters:

Cells rectangular in girdle view.

Valves lanceolate and sometimes with slightly produced ends.

Transapical striae lineate (crossed by finer longitudinal striation).

Two chloroplasts per cell, one at each side of the girdle.

*Navicula directa* (W. Smith) Ralfs in Pritchard (Plate 63, Table 70)

**Basionym:** *Pinnularia directa* W. Smith.

**References:** Smith, 1853, p. 56, Plate 18, Fig. 172; Pritchard, 1861, p. 906; Gran & Angst, 1931, p. 499, Fig. 87; Heimdal, 1970, Figs. 25–28.

Valves narrow and lanceolate with subacute ends. Raphe–sternum indistinct. Striae parallel and uniformly spaced throughout the whole valve. Each chloroplast covering the girdle from end to end.

*Navicula distans* (W. Smith) Ralfs in Pritchard (Plate 63, Table 70)

**Basionym:** *Pinnularia distans* W. Smith.

**References:** Smith, 1853, p. 56, Plate 18, Fig. 169; Pritchard, 1861, p. 907; Gran & Angst, 1931, p. 499, Fig. 86; Cupp, 1943, p. 193, Fig. 143.

Valves lanceolate. Striae radiate. Each chloroplast covering less than half of each side of the girdle.

*Navicula transitans* var. *derasa* (Grunow, in Cleve & Grunow) Cleve (Plate 63, Table 70)

**Basionym:** *Navicula derasa* Grunow in Cleve & Grunow.

**References:** Cleve & Grunow, 1880, p. 39, Plate 2, Fig. 46; Cleve, 1883, p. 467, Plate 36, Figs. 31, 33, and 37; Heimdal, 1970, Figs. 12–18.

Valves lanceolate with slightly rostrate ends. Sternum narrow and not centrally expanded. Striae parallel to radiate, closer together near the ends than in the middle of the valves. Chloroplasts often asymmetrical and not covering the whole length of each side of the girdle.

***Navicula transitans* var. *derasa* f. *delicatula* Heimdal (Plate 63, Table 70)**

**Reference:** Heimdal, 1970, p. 72, Figs. 30–37.

Valves lanceolate to elliptical, mostly with slightly rostrate ends. Striae parallel and uniformly spaced throughout the valve. Each of the two chloroplasts covering most of each side of the girdle.

**Distribution:** Uncertain.

**How to identify:** Size and position of the chloroplasts are useful distinctive characters. Positive identification requires examination of cleaned valves mounted in a medium of a high refractive index. Due to the coarse silicification *N. directa* and *N. distans* are best examined in brightfield illumination.

### B. Genus *Pleurosigma* W. Smith 1852

**Type:** *Pleurosigma angulatum sensu* W. Smith emend. Sterrenburg.

**Basionym:** *Navicula angulata* Quekett *pro parte quoad* *typum*.

**Synonyms:** See Sterrenburg, 1991a.

The genus was last monographed 100 years ago (Peragallo, 1891), and many more taxa have been introduced since then without a revision of the genus. Recently Cardinal et al. (1989) introduced criteria for species characterization, revealed by SEM, and Sterrenberg (1991b) pointed out LM criteria suitable for taxonomic purposes.

There are some 250 major taxonomic entries for *Pleurosigma* in VanLandingham (1978), 90 of them are listed as valid. According to the information given by Cupp (1943), Hendey (1964), and Simonsen (1974), less than one-tenth appear more or less regularly in the plankton. Two species are treated here, viz. *Pleurosigma normanii*, the most common and most widely spread of all *Pleurosigma* species, found from the tropics to the polar seas, often in the plankton (Hendey, 1964), and *P. directum*, which has been characterized as an “almost cosmopolitan plankton species” (Simonsen, 1974, p. 45). A third species, *P. simonsenii*, was described as a planktonic species from the Indian Ocean (Simonsen, 1974) and later recorded as abundant in the phytoplankton of the western English Channel (Boalch & Harbour, 1977).

**Distinctive characters:**

Valves more or less flattened, gently sigmoid, or almost straight.

Valve outline lanceolate.

Raphe straight or more or less sigmoid and central.

Three striae systems: one transverse and two oblique.

Two or four elongated chloroplasts, often extremely convoluted and lying under valve face rather than along girdle, many pyrenoids per chloroplast (Cox, 1981).

Characters showing differences between subgroups or species:

Shape of valve.

Curvature of raphe.

Crossing angle of striae.

Areolation at valve apices.

Color in standardized darkfield (Sterrenburg, 1991b).

*Pleurosigma directum* Grunow in Cleve & Grunow (Plate 62, Table 71)

References: Cleve & Grunow, 1880, p. 53; Peragallo, 1891, p. 14, Plate 5, Fig. 29; Simonsen, 1974, p. 45, Plate 29, Fig. 2.

Valves rhombo-lanceolate to elliptic-lanceolate.

Raphe almost straight.

*Pleurosigma normanii* Ralfs in Pritchard (Plate 62, Table 71)

References: Pritchard, 1861, p. 919; Cupp, 1943, p. 196, Fig. 148; Sterrenburg, 1991b, Fig. 2.

Valves broadly lanceolate, slightly sigmoid, with subacute ends. Raphe nearly central, sigmoid with single curvature. Raphe-sternum or central nodule dilated transversely. Crossing angle of striae greater at center than toward valve apices. Color in standardized darkfield deep blue with silverish center (Sterrenburg, 1991b).

*Pleurosigma simonsenii* Hasle nom. nov. (Table 71)

Synonym: *Pleurosigma planctonicum* Simonsen.

References: Simonsen 1974, p. 46, Plate 30; Boalch & Harbour, 1977.

Valves slightly sigmoid near the ends and flat; ends acute and not protracted. Raphe straight, sigmoid before the ends, central in the middle, eccentric before the ends, central pores close together. Raphe-sternum narrow and not centrally expanded. Valve thin and striation hardly visible with LM. No color in standardized darkfield (Sterrenburg, personal communication).

TABLE 71 Morphometric Data of *Pleurosigma* spp.

Species	Apical axis ( $\mu\text{m}$ )	Transapical axis ( $\mu\text{m}$ )	Striae in 10 $\mu\text{m}$	
			Transverse	Oblique
<i>P. directum</i>	180-270	44	—	18.5
<i>P. normanii</i>	90-220	28-36	19-22	16-19
<i>P. simonsenii</i>	300-600	40-75	28-30	ca. 30

Note. —, No data.

**Distribution:** All three species are probably cosmopolitan.

**How to identify:** If possible to see at all with LM, the striation can only be seen on cleaned valves mounted in a medium of a high refractive index or also occasionally as a dry mount. The large size and the extremely delicate valve striation characterize *P. simonsenii*.

**Remarks:** *Pleurosigma planctonicum* Simonsen is a later homonym of *P. planctonicum* Cleve-Euler (see Taxonomic Appendix). *Gyrosigma* Hassall, separated from *Pleurosigma* by having longitudinal and transverse (no oblique) striae, is another large genus with a few species occasionally occurring in marine and brackish water plankton, e.g., *G. macrum* (W. Smith) Griffith & Henfrey (Sterrenburg, personal communication).

### C. The “Tropidoneis” group

Terminology mainly used for the *Tropidoneis* group (Paddock & Sims, 1981; Paddock, 1988).

**Raphe ridge**—a simple angular elevation of the valve which bears the raphe and raises it, but which lacks specialized supporting structures.

**Valve face**—the whole valve surface.

**Greater and lesser parts of valve face**—the two parts of valve face divided by the raphe, termed “greater face” and “lesser face,” respectively, by Paddock (1988).

**Raphe fins**—paired external small vane-like (blade, plate-like) siliceous structures, each shaped as a shark’s dorsal fin (SEM) and arising from the sternum (also present in *Stauroopsis*).

**Notes:** Paddock & Sims (1981, p. 178): “In practice it proved extremely difficult to decide whether some diatoms have a raphe ‘raised upon a keel’ or whether the valve of the diatom which is ‘highly vaulted’ is merely laterally compressed to an extreme degree.” Paddock (1988, p. 14): “It would seem preferable to distinguish the raphe ridge [defined above] from the raphe keel in which specialized supporting structures i.e., fibulae are present.” The shape of the raphe fins will scarcely be seen with LM although their presence should be discernible in girdle view, especially when phase or interference contrast optics are used.

Common characters:

Intact frustules as well as single valves usually lying in broad girdle view.

Valves linear to lanceolate.

Valves and raphe straight and not sigmoid.

Raphe more or less ridged and raised above the general level of the valve.



Raphe without fibulae.

Large helictoglossae.

Characters showing differences between genera:

Shape of frustule in girdle view.

Valves vaulted or ridged.

Shape of valve ridge in girdle view.

Size of the two parts of the valve face on each side of the raphe (equal, subequal, or unequal in area).

The presence or absence of raphe fins.

1. Former *Navicula*—usually solitary

**Genus** *Ephemera* Paddock 1988

**Type:** *Ephemera planamembranacea* (Hendey) Paddock.

Monospecific genus.

*Ephemera planamembranacea* (Hendey) Paddock (Plate 64)

**Basionym:** *Navicula planamembranacea* Hendey.

**References:** Hendey, 1964, p. 188, Text Fig. 8; Paddock, 1988, p. 86, Plate 31.

Cells usually solitary. Valves highly vaulted and flattened in transapical plane. Raphe separating the valve face into two unequal parts. Central nodule slightly depressed, usually with four stronger and more widely spaced interstriae, reaching valve margin and producing “the impression of a pseudo-stauros” (Hendey, 1964, p. 188). Small raphe fins near valve ends and one on each side of the central nodule. Numerous small and rounded chloroplasts.

**Morphometric data:** Pervalvar axis, 15–30  $\mu\text{m}$ ; apical axis, 66–90  $\mu\text{m}$ ; transapical axis, 8–10  $\mu\text{m}$ ; transapical striae, 28–30 in 10  $\mu\text{m}$ .

**Distribution:** North Atlantic Ocean.

**Remarks:** Due to the shape of the cell it is usually seen in girdle view where the central and terminal nodules of the raphe are more distinct than the delicate striae. *Ephemera planamembranacea* is more similar to “*Tropidoneis*” than to *Navicula sensu stricto* and is therefore dealt with under this group, although, in the past, it has never been referred to *Tropidoneis*. It is also similar to *Stauropsis* but differs from this genus in chloroplast number and shape and by usually being solitary.

---

PLATE 64 *Ephemera planamembranacea*: cell in girdle view with four stronger, central interstriae, small paired raphe fins, and large helictoglossae. After Paddock (1988). *Banquisia belgicae*: cell in girdle view with raphe fins. *Membraneis challengerii*: cell in girdle view with reinforced striae, raphe fins, and enlarged helictoglossae. Scale bars = 10  $\mu\text{m}$ .

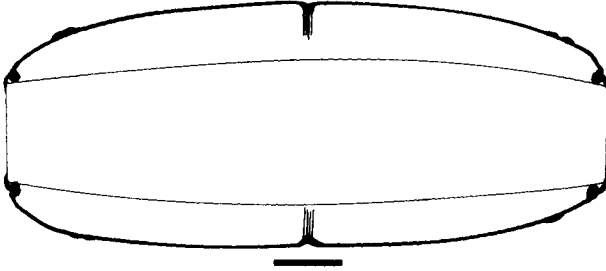

*Ephemera planamembranacea*

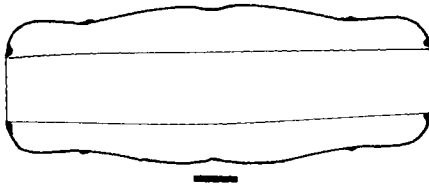

*Banquisia belgicae*

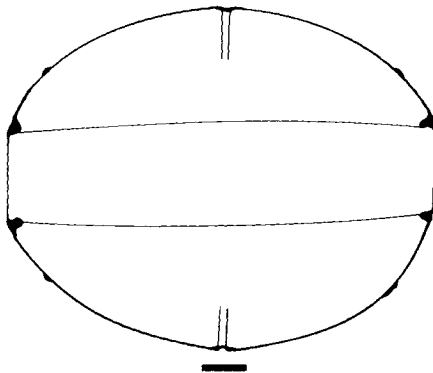

*Membraneis challengeri*

2. Former *Tropidoneis* spp.—usually in ribbons.  
 2a. Valves lying in girdle view vaulted to a high ridge.

**Genus *Banquisia* Paddock 1988**

**Type:** *Banquisia belgicae* (Van Heurck) Paddock.

Monospecific genus.

***Banquisia belgicae* (Van Heurck) Paddock (Plate 64, Table 72)**

**Basionym:** *Amphiprora belgicae* Van Heurck.

**Synonym:** *Tropidoneis belgicae* (Van Heurck) Heiden (in Heiden & Kolbe, 1928).

**References:** Van Heurck, 1909, p. 14, Plate 1, Figs. 11 and 15; Heiden & Kolbe, 1928, p. 655, Plate 4, Figs. 98 and 99; Paddock, 1988, p. 79, Plate 28; Paddock, 1990, p. 153, Fig. 10.

Raphe biarcuate in girdle view: a depression at central nodule and another at about one-third of the raphe's length from the valve apices. Poles steep. A pair of raphe fins at or near lowest point in raphe outline. Valves narrow with equal parts of valve face. Punctate transverse valve striae clearly seen with LM. Interstriae in the middle of the valve slightly broader than the others.

**Genus *Membraneis* Paddock 1988**

**Type:** *Membraneis challengerii* Grunow, in Cleve & Grunow Paddock.

Generic characters:

Cells more or less lens shaped in girdle view.

Valves with unequal or subequal parts of valve face.

Characters showing differences between species:

Valve outline in girdle view.

**TABLE 72 Morphometric Data of *Banquisia*, *Membraneis*, *Manguinea*, and *Plagiotropis* spp. (after Paddock, 1988)**

Species	Apical axis ( $\mu\text{m}$ )	Transverse striae in 10 $\mu\text{m}$
<i>Banquisia belgicae</i>	70–125	16–20
<i>Membraneis challengerii</i>	85–270	18–24
<i>Membraneis imposter</i>	80–125	15–16
<i>Manguinea fusiformis</i>	48–135	26–28
<i>Manguinea rigida</i>	60–80 (120)	24 (18)
<i>Plagiotropis gaussii</i>	102–159	15–18

*Note.* Numbers in parentheses occasionally found.

The presence or absence of raphe fins.

The presence or absence of reinforced striae at the central area.

Coarseness of valve striation.

***Membraneis challengerii*** Grunow, in Cleve & Grunow Paddock (Plate 64, Table 72)

**Basionym:** *Navicula challengerii* Grunow in Cleve & Grunow.

**Synonym:** *Tropidoneis antarctica* (Grunow in Cleve & Möller) Cleve (for other synonyms see Paddock, 1988, p. 81).

**References:** Cleve & Grunow, 1880, p. 64; Cleve, 1894b, p. 24; Paddock, 1988, p. 81, Plate 29; Paddock, 1990, p. 153, Fig. 11.

Valve outline in girdle view a smooth curve from end to end. Raphe fins present about one-eighth of the valve length from the ends of the valve.

Enlarged helictoglossae. Reinforced striae at central nodule varying in number and development. Flat unequal parts of valve face. Punctate valve striae just visible with LM.

***Membraneis imposter*** Paddock (Table 72)

**Reference:** Paddock, 1988, p. 84, Plate 30; Paddock, 1990, p. 153, Figs. 12 and 13.

Raphe ridge in girdle view convex and slightly depressed at central nodule, poles sloping, slightly concave shoulder at about one-eighth of valve's length from each pole. No raphe fins and no reinforced striae at the central area. The two parts of valve face markedly unequal. Valve striae coarsely punctate.

2b. Valves lying in girdle or valve view; valves with only a low ridge.

**Genus *Manguinea*** Paddock 1988

**Type:** *Manguinea fusiformis* (Manguin) Paddock.

Generic characters:

Valves long and narrow with unequal faces.

Ridge not lobed.

Raphe fins or similar structures present.

Valve striae with separate puncta delicate and often difficult to see with LM.

Characters showing differences between species:

Valve outline in girdle view.

Size of raphe fins.

Size of helictoglossae.

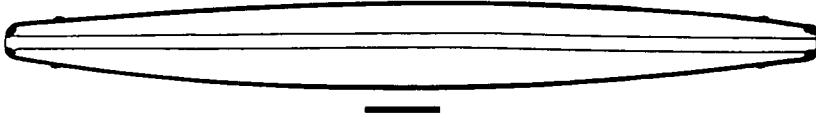

*Manguinea fusiformis*

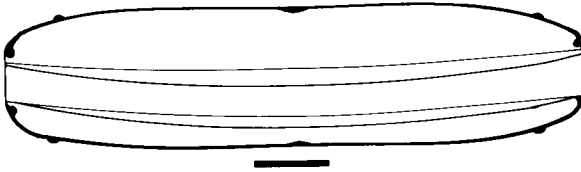

*Manguinea rigida*

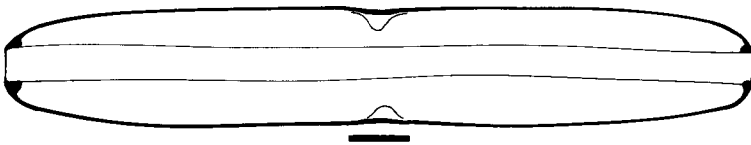

*Plagiotropis gaussii*

PLATE 65 *Manguinea fusiformis*: cell in girdle view and enlarged helictoglossae and fin like structures. After Paddock (1988). *Manguinea rigida*: cell in girdle view with small raphe fins. After Paddock (1988) *Plagiotropis gaussii*: Cell in girdle view. After Paddock (1988). Scale bars = 10  $\mu\text{m}$

***Manguinea fusiformis*** (Manguin) Paddock (Plate 65, Table 72)**Basionym:** *Tropidoneis fusiformis* Manguin.**References:** Manguin, 1957, p. 130, Plate 6, Fig. 39; Paddock, 1988, p. 88, Plate 32; Paddock, 1990, p. 153, Fig. 14.

Frustule fusiform in girdle view. Valve outline slightly narrowed before poles, poles appearing slightly attenuated. Raphe fin-like structures positioned in the narrow parts. Enlarged helictoglossae.

***Manguinea rigida*** (M. Peragallo) Paddock (Plate 65, Table 72)**Basionym:** *Amphiprora rigida* M. Peragallo.**Synonym:** *Tropidoneis glacialis* Heiden in Heiden & Kolbe.**References:** Van Heurck, 1909, Plate 1, Fig. 19; Peragallo, 1924, p. 21; Heiden & Kolbe, 1928, p. 656, Plate 5, Fig. 100; Paddock, 1988, p. 90, Plate 33; Paddock, 1990, p. 153, Fig. 15.

Frustules in girdle view with parallel sides and bluntly rounded ends. Raphe fins small. Helictoglossae moderately sized.

**Genus *Plagiotropis*** Pfitzer 1871 emend. Paddock 1988**Type:** *Plagiotropis baltica* Pfitzer.

The following species may be found in plankton:

***Plagiotropis gaussii*** (Heiden, in Heiden & Kolbe) Paddock (Plate 65, Table 72)**Basionym:** *Tropidoneis gaussii* Heiden in Heiden & Kolbe.**References:** Heiden & Kolbe, 1928, p. 656, Plate 5, Fig. 102; Paddock, 1988, p. 63, Plate 24; Paddock, 1990, p. 152, Figs. 5 and 6.

Valves delicate with narrow transapical axis and lying in girdle view. Whole frustules slightly waisted. Valve ridge very low and gently curving. Valve outline narrowed to a slight shoulder some distance before the valve poles. Raphe fins absent. Helictoglossae unusually large. Punctate transverse valve striae. Puncta visible with LM.

**Distribution:** Southern cold water region.

**How to identify:** Most of these species are easier to identify in girdle than in valve view. Acid-cleaned material studied with phase or interference contrast is recommended.

**Remarks:** Some of these species are similar to *Amphiprora* spp.

(= *Entomoneis* Ehrenberg in Patrick & Reimer, 1975) in gross morphology. *Amphiprora* occurs on brackish and marine sediments, occasionally in freshwater (Round et al., 1990); some species referred to *Amphiprora* in the past are extremely abundant in connection with ice in the Arctic and the Antarctic. *Amphiprora* and *Tropidoneis* have usually been regarded as closely related; EM observations disproved this, the main distinction being the internal structure of the keel of the valve (Paddock & Sims, 1981).

#### D. Genus *Pachyneis* Simonsen 1974

**Type:** *Pachyneis gerlachii* Simonsen.  
Monospecific genus.

##### *Pachyneis gerlachii* Simonsen

**References:** Simonsen, 1974, p. 49, Plates 33 and 34; Paddock, 1986, p. 94, Figs. 19 and 20.

**Girdle view:** Cells almost elliptical.

**Valve view:** Fusiform and highly vaulted. Valve membrane extremely delicate with a varying number of longitudinal folds, two to four on each side of the raphe. Raphe straight except for arching sideways near the central nodule. Vane-like structures (raphe fins?) near the poles. Striae parallel (interference contrast).

**Morphometric data:** Apical axis, 100–370  $\mu\text{m}$ ; transapical axis, ca. 25–80  $\mu\text{m}$ ; 30–32 transapical striae in 10  $\mu\text{m}$ .

**Distribution:** Warm water region.

**How to identify:** The most characteristic feature is probably the longitudinal folds; high contrast and high resolution are needed to reveal the striation.

#### Family Bacillariaceae Ehrenberg 1831

The genera dealt with here were all placed in Nitzschiaceae Grunow 1860 by Simonsen (1979) and, with the exception of one genus, also by Glezer et al. (1988), whereas Round et al. (1990) used the older name Bacillariaceae. Only a few of the 15 genera included in Bacillariaceae *sensu* Round et al. are represented in marine plankton. *Bacillaria paxillifera* appears occasionally in plankton of shallow waters being swept up from the bottom. *Cylindrotheca* has its main distribution in and on mud; however, *C. closterium* (= *Nitzschia closterium*) has been recorded from a variety of habitats, including marine plankton. *Neodenticula* has several fossil but only one living marine planktonic species. *Nitzschia* had around 900 nomenclaturally valid species at the time when Mann (1986) wrote the paper “*Nitzschia* subgenus *Nitzschia* (Notes for a monograph of the Bacillariaceae, 2).” Of special interest to marine planktologists is the fact that his EM observations of the subgenus, including the generitype *N. sigmoidea* (Nitzsch) W. Smith, indicate that most of the marine planktonic so-called *Nitzschia* species are probably too remote morphologically from the generitype to fit into the genus. This is especially true for *Fragilariopsis* and *Pseudo-nitzschia* which in this chapter will be treated as separate genera.

Terminology specific to Bacillariaceae (Anonymous, 1975; Ross et al., 1979; Mann, 1978): (Fig. 18)

Canal raphe system consisting of

**Raphe canal**—a space on the inner side of the raphe cut off to a greater or lesser extent from the rest of the interior of the frustule.

**Fibula**—a bridge of silica between portions of the valve on either side of the raphe (= keel punctum).

**Interspace**—the space between two fibulae.

**Central interspace**—the space between the two central fibulae.

**Keel**—the summit of the ridge bearing the raphe.

A central interspace larger than the others usually indicates the presence of two raphe slits, i.e., the presence of central raphe endings and a central nodule. Since a larger central interspace is observed with LM, but not always the corresponding central raphe endings and a central nodule, “central larger interspace” is a repeatedly used term in this chapter. In the past the wording was “die beiden mittleren Kielpunkte weiter voneinander entfernt” (e.g., Hustedt, 1958a) and “the two keel puncta in the middle more widely spaced than the others” (e.g., Hasle, 1965a,b). It should also be noted that the same authors used the term “pseudonodulus” instead of “central nodule” for the Bacillariaceae.

Characters of the genera dealt with:

Cells in chains of various types or more seldom solitary.

Cells rectangular or spindle shaped in girdle view.

Valves elongate although variable in outline.

Raphe with bridges of silica cross-linking the valve beneath the raphe (“canal raphe”).

Raphe usually strongly eccentric running along one valve margin.

Chloroplasts usually two plates, one toward each pole of the cell.

Resting spores uncommon.

## KEY TO GENERA

- |   |  |
|---|--|
| 1a. Raphe system eccentric . . . . .  | 2  |
| 1b. Raphe system central . . . . .  | <i>Bacillaria</i> , p. 293                   |
| 2a. Cells usually in chains . . . . .                                       | 3  |
| 2b. Cells usually solitary . . . . .  | 4  |
| 3a. Cells united by valve surfaces into ribbons . . . . .                   | 5  |
| 3b. Cells united by overlap of valve ends into stepped chains . . . . .     | <i>Pseudo-nitzschia</i> , p. 307             |
| 4a. Frustules usually spirally twisted, valves lightly silicified . . . . . | <i>Cylindrotheca</i> , p. 293                |
| 4b. Frustules not spirally twisted . . . . .                                | <i>Nitzschia</i> , <i>pro parte</i> , p. 324 |



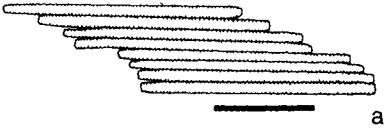

a



b

*Bacillaria paxillifera*

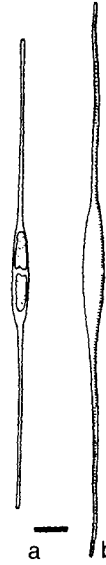

a

b

*Cylindrotheca closterium*

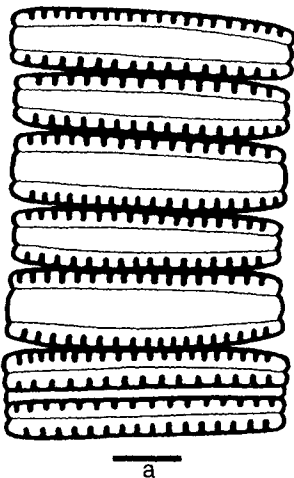

a

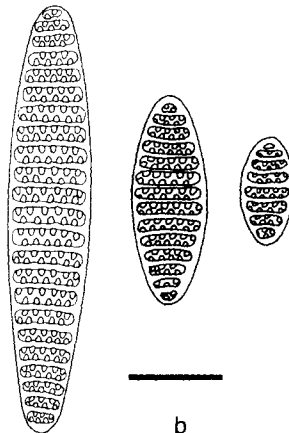

b

*Fragilariopsis kerguelensis*

PLATE 66 *Bacillaria paxillifera*: (a) part of chain in girdle view. Scale bar = 50  $\mu\text{m}$ ; (b) valve end with raphe and striae. After Cupp (1943). Scale bar = 10  $\mu\text{m}$ . *Cylindrotheca closterium*: (a) cell in girdle view; (b) valve with fibulae visible. Scale bar = 10  $\mu\text{m}$ . *Fragilariopsis kerguelensis*: (a) ribbon in girdle view, curved valve faces, strong interstriae. From Hasle (1968b). Scale bar = 10  $\mu\text{m}$ . (b) larger specimen heteropolar, medium sized and smaller specimens isopolar, and transverse striae with two distinct rows of poroids. Scale bar = 10  $\mu\text{m}$ .

5a. Valve interior with transapical pseudosepta . . . . *Neodenticula*, p. 305

5b. Valve interior without pseudosepta . . . . . *Fragilariopsis*, p. 295

**Genus *Bacillaria*** J. F. Gmelin 1791

**Type:** *Bacillaria paradoxa* J. F. Gmelin.

**Correct name:** *Bacillaria paxillifera* (O. F. Müller) Hendey.

***Bacillaria paxillifera*** (O. F. Müller) Hendey (Plate 66)

**Basionym:** *Vibrio paxillifer* O. F. Müller.

**Synonyms:** *Bacillaria paradoxa* J. F. Gmelin; *Nitzschia paradoxa* (J. F. Gmelin) Grunow in Cleve & Grunow.

**References:** Müller, 1783, pp. 277 and 286; Gmelin, 1791, p. 3903; Cleve & Grunow, 1880, p. 85; Cupp, 1943, p. 206, Fig. 159; Hendey, 1951, p. 74; Hendey, 1964, p. 274, Plate 21, Fig. 5; Drum & Pankratz, 1966; Round et al., 1990, p. 608.

**Girdle view:** Cells rectangular; cells in colonies sliding along one another to form a linear array to retract into a tabular array.

**Valve view:** Valves linear lanceolate with produced ends. Raphe system slightly keeled. Raphe continuous from pole to pole. Fibulae strong. Valve surface with transverse parallel striae.

**Morphometric data:** Apical axis, 70–115  $\mu\text{m}$ ; transapical axis, 5–6  $\mu\text{m}$ ; 7–9 fibulae and 20–21 striae in 10  $\mu\text{m}$ .

**Distribution:** Probably cosmopolitan.

**How to identify:** *Bacillaria* may consist of more than one species (Round et al., 1990). *Bacillaria paxillifera* seems to be the only one recorded from plankton, however. Due to the unique type of motile colonies the species may be identified in water mounts. Permanent mounts may be needed for identification of single valves.

**Genus *Cylindrotheca*** Rabenhorst 1859

**Type:** *Cylindrotheca gerstenbergeri* Rabenhorst.

**Correct name:** *Cylindrotheca gracilis* (Brébisson in Kützing) Grunow (*vide* Van Heurck, 1880–1885, p. 186).

The usual characterization of the genus *Cylindrotheca* is

Frustules cylindrical, fusiform, twisted about the apical axis, and rotating when in motion. Very weakly silicified, girdle bands narrow and numerous, and the valves appear to be hyaline in LM.

Reimann & Lewin (1964) redefined the genus and transferred *N. closterium* (Ehrenberg) W. Smith to *Cylindrotheca* probably based on a similarity with *Cylindrotheca* in raphe structure (TEM) and the weakly silicified valves.

***Cylindrotheca closterium*** (Ehrenberg) Lewin & Reimann (Plate 66)**Basionym:** *Ceratoneis closterium* Ehrenberg.**Synonym:** *Nitzschia closterium* (Ehrenberg) W. Smith.**References:** Ehrenberg, 1841a, p. 144, Plate 4, Fig. 7; Smith, 1853, p. 42, Plate 15, Fig. 120; Cupp, 1943, p. 200, Fig. 153; Hendey, 1964, p. 283, Plate 21, Fig. 8; Hasle, 1964, p. 16, Text Figs. 1–10, Plate 7, Figs. 1–12, Plate 9, Figs. 1–9, Plate 10, Figs. 1–4; Reimann & Lewin, 1964, p. 289, Plate 124, Figs. 1–4, Plate 125, Figs. 1–4, Plate 126, Figs. 1–3; Takano, 1990, pp. 320–321; Hasle & Medlin, 1990a, p. 177, Plate 23.1, Figs. 1–4.**Emended description** (Reimann & Lewin, 1964, p. 289)

Frustules in the fusiform part not twisted, in the rostra not or only slightly twisted about the apical axis. Valve face weakly silicified, almost imperforate, traversed by more or less transapical silicified thickenings. Raphe traversed by a series of fibulae, joined directly to the valve face. One of the edges of the valve bordering the fissure minutely serrate. Fissure interrupted at the center. Two chromatophores.

It should be kept in mind that the valves of the other *Cylindrotheca* species examined by the same authors consisted of a canal raphe solely, and the frustules were twisted two to three times about the apical axis. The lack of, or the insignificant twisting of the *C. closterium* cell, together with the presence of a striated valve face, indicates a rather isolated position of this diatom within *Cylindrotheca*. There are, therefore, still reasons for not using Reimann & Lewin's combination but instead to retain the name *Nitzschia closterium* until more thorough studies of marine planktonic species of the "*N. closterium*" shape from various types of habitats have been performed. It is true, however, that the species in question does not belong to *Nitzschia sensu stricto* (see also Medlin, 1990 for rRNA molecule studies of *C. closterium* and *Nitzschia* spp.).

**Morphometric data:** Apical axis, 30–400  $\mu\text{m}$ ; transapical axis, 2.5–8  $\mu\text{m}$ ; fibulae, 10–12 in 10  $\mu\text{m}$ ; interstriae, 70–100 in 10  $\mu\text{m}$  (TEM; Hasle, 1964).**Distribution:** Cosmopolitan?—planktonic and common on seaweeds and polar ice.**How to identify:** The identification of *C. closterium* may have caused more problems and more confusion than the identification of any other diatom encountered in marine plankton (see *Lennoxia faveolata* and *Phaeodactylum tricorutum*). When working with coastal material the most common problem is distinguishing between *C. closterium* and the coarser *N. longissima*; examination of water mounts is usually not sufficient. Not too thoroughly acid-cleaned material is better since this often shows the two delicate valves and the many bands of *C. closterium* lying together, seemingly twisted around each other in the rostrate ends.

**Genus *Fragilariopsis*** Hustedt in Schmidt emend. Hasle 1993

**Type:** *Fragilariopsis antarctica* (Castracane) Hustedt in A. Schmidt.

**Basionym:** *Fragilaria antarctica* Castracane.

**Correct name:** *Fragilariopsis kerguelensis* (O'Meara) Hustedt (*vide* Hustedt, 1952, p. 294).

Glezer et al. (1988) and Round et al. (1990) regarded *Fragilariopsis* as a separate genus. Since this is also done in this chapter, the new names and combinations introduced by Hasle (1972c, 1974, see the synonymy list) are inappropriate.

*Fragilariopsis* has a canal raphe which justifies the placement in the family Bacillariaceae. The raphe system as seen with EM is simple in construction compared to that of *N. sigmoidea* and several other *Nitzschia* species (Mann, 1986). The raphe is not raised above the valve surface, the external canal wall is not poroid, and the fibulae are small and not extending across the valve (Hasle, 1965a, 1968c, 1972c; Mann, 1978). In further contrast to the subgenus *Nitzschia*, *Fragilariopsis* has no conopea (flaps of silica extending out from near the raphe), most species are narrow, not sigmoid in girdle view, and the valve striae mostly have two rows of poroids.

The little information available from EM observations on the *Fragilariopsis* girdle demonstrates a certain unconformity that may to some extent be related to the silicification of the cell wall. The lightly silicified *F. oceanica* has several distinctly striated intercalary bands, whereas those of the more heavily silicified *F. cylindrus* and *F. curta*, and especially *F. kerguelensis*, have one or perhaps two bands with one row of perforations (Hasle, 1965a, 1972c; Medlin & Sims, 1993).

All *Fragilariopsis* species examined by Hasle (1965a) are present in polar waters and are dealt with in the handbook "Polar Marine Diatoms" (Medlin & Priddle, 1990) in which a key to species is constructed (Hasle & Medlin, 1990b), as was also done by Hasle (1965a). In this chapter we include only the species more commonly recorded from plankton. For the examination of samples collected from or near sea ice Hasle & Medlin (1990b) should be consulted.

Generic characters:

Cells rectangular in girdle view.

Cells in ribbons united by the entire or the greater part of the valve surface.

Raphe strongly eccentric.

Raphe not raised above the general level of the valve.

Approximately equal numbers of interstriae and fibulae.

Fibulae often more distinct than interstriae (LM).

Central larger interspace lacking in most species.

Valve face more or less flattened and not undulated.

Valves narrowly elliptical to lanceolate to broadly elliptical or subcircular, or linear to sublinear.

Apical axis often heteropolar.

Valve poles usually bluntly rounded.

Striae parallel except near poles.

Striae with two rows of poroids, seldom one or more than two.

Chloroplasts—two plates lying along the girdle, one on either side of the median transapical plane.

Resting spores rare (one species).

Characters showing differences between species:

Valve outline.

Polarity of apical axis.

The presence or absence of central larger interspace.

Structure of striae, discernible or not discernible with LM.

A. Valves elliptical to lanceolate.

1. Apical axis often heteropolar; apices generally rounded: *F. kerguelensis*, *F. ritscheri*, and *F. atlantica* (Table 73).
2. Apical axis isopolar; apices more or less rounded: *F. oceanica* and *F. pseudonana* (Table 73).
3. Apical axis isopolar; apices generally pointed: *F. rhombica* and *F. separanda* (Table 73).

B. Valves linear to sublinear.

1. Apical axis isopolar: *F. cylindrus* and *F. cylindriformis* (Table 73).
2. Apical axis heteropolar: *F. curta* (Table 73).

C. Valves semilanceolate: *F. doliolus* (Table 73).

A. Valves elliptical to lanceolate.

1. Apical axis often heteropolar, apices generally rounded.

***Fragilariopsis kerguelensis*** (O'Meara) Hustedt (Plate 66, Table 73)

**Basionym:** *Terebraria kerguelensis* O'Meara.

**Synonyms:** *Fragilariopsis antarctica* (Castracane) Hustedt in A. Schmidt; *Nitzschia kerguelensis* (O'Meara) Hasle.

**References:** O'Meara, 1877, p. 56, Plate 1, Fig. 4; Castracane, 1886, p. 56, Plate 25, Fig. 1; Schmidt, 1913, Plate 299, Figs. 9–14; Hustedt, 1952, p. 294; Hustedt, 1958a, p. 162, Figs 121–127; Hasle, 1965a, p. 14, Plate 4,

TABLE 73 Morphometric Data of *Fragilariopsis* spp.

Species	Apical axis ( $\mu\text{m}$ )	Transapical axis ( $\mu\text{m}$ )	Striae and fibulae in 10 $\mu\text{m}$
Group A			
<i>F. kerguelensis</i>	10–76	5–11	4–7
<i>F. ritscheri</i>	22–57	8–9	6–11
<i>F. atlantica</i>	20–43	7–8	18–21
<i>F. oceanica</i>	10–41	ca. 6	12–15
<i>F. pseudonana</i>	4–20	3.5–5	18–22
<i>F. rhombica</i>	8–53	7–13	8–16
<i>F. separanda</i>	10–33	8–13	10–14
Group B			
<i>F. cylindrus</i>	3–48	2–4	13–17
<i>F. cylindriformis</i>	3–13	ca. 2	16–20
<i>F. curta</i>	10–42	3.5–6	9–12
Group C			
<i>F. doliolus</i>	30–70	5–8	9–14

Figs. 11–18, Plate 7, Fig. 9; Hasle, 1968c, Figs. 1, 2, and 7–9; Hasle, 1972c, p. 115; Sournia et al., 1979, Fig. 33; Hasle & Medlin, 1990b, p. 181, Plate 24.2, Figs. 11–18.

**Girdle view:** Valve face slightly curved; valve faces of sibling cells united for the greater part of the cell length. Interstriae coarse, penetrating deeply into the cell interior, readily seen with LM.

**Valve view:** Larger (ca. 40–70  $\mu\text{m}$ ) specimens narrowly elliptical with heteropolar apical axis, smaller specimens broadly lanceolate to broadly elliptical with isopolar apical axis. Transverse striae parallel, slightly curved near apices, two rows of large poroids, readily seen with LM. No central larger interspace (raphe uninterrupted from pole to pole, SEM).

**Remarks:** The coarse interstriae shaped as anvils in cross section and thus similar to pseudosepta indicate a close relationship to *N. seminae*.

***Fragilariopsis ritscheri* Hustedt (Plate 67, Table 73)**

**Synonym:** *Nitzschia ritscheri* (Hustedt) Hasle.

**References:** Hustedt, 1958a, p. 164, Figs. 133, 136, and 153; Hustedt, 1958b, p. 205, Figs. 16 and 17; Hasle, 1965a, p. 20, Plate 4, Figs. 1–7, Plate 7, Fig. 8; Hasle, 1968c, Fig. 10; Hasle, 1972c, p. 115; Hasle & Medlin, 1990b, p. 181, Plate 24.2, Figs. 1–10.

**Valve view:** Larger (ca. 40–70  $\mu\text{m}$ ) specimens narrowly elliptical, apical axis slightly heteropolar, one pole broadly rounded, the other more pointed; smaller specimens more broadly elliptical with inconsiderable heteropolarity. Valves broad in relation to their length; middle part of

Fragilariopsis

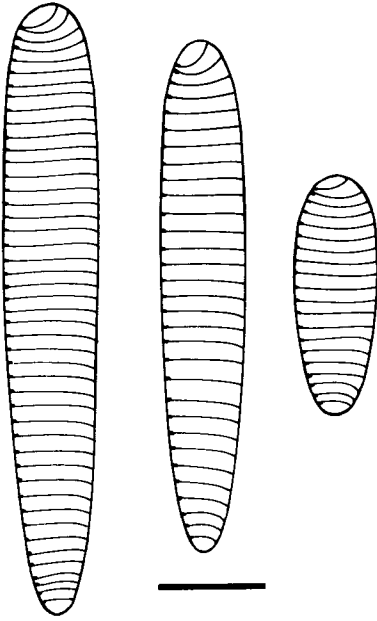

*F. ritscheri*

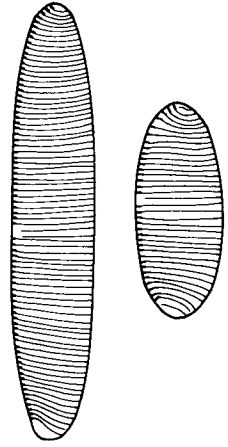

*F. atlantica*

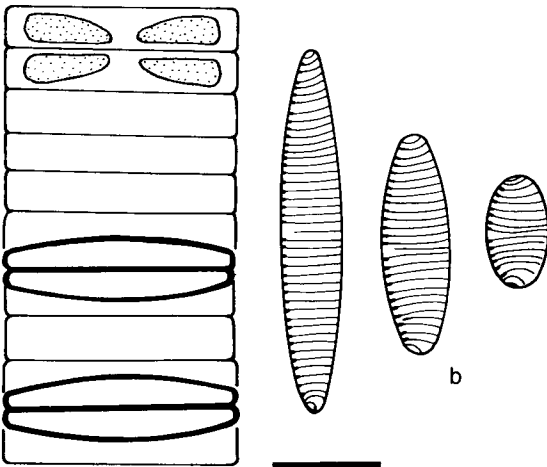

a

*F. oceanica*

b

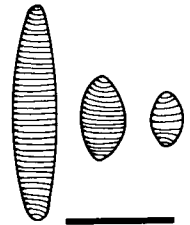

*F. pseudonana*

valve with slightly curved margins. Transverse striae with two rows of small poroids discernible in cleaned valves mounted in a medium of a high refractive index. No central larger interspace.

***Fragilariopsis atlantica* Paasche (Plate 67, Table 73)**

**Synonym:** *Nitzschia paaschei* Hasle.

**References:** Paasche, 1961, p. 199, Fig. 1b, Plate 1, b–f; Hasle, 1965a, p. 9, Plate 1, Figs. 1–5, Plate 2, Figs. 1–3; Hasle, 1974, p. 426; Hasle & Medlin, 1990b, p. 181, Plate 24.1, Figs. 1–5.

**Girdle view:** Valves flat, cells fairly low; valves of sibling cells in ribbons united along their whole length with no interspace. Interstriae weak, discernible with LM.

**Valve view:** Largest (ca. 40  $\mu\text{m}$ ) specimens broadly linear with more or less obtuse apices, slightly heteropolar apical axis; medium-sized valves lanceolate with slightly pointed apices and isopolar apical axis; smallest specimens broadly elliptical with broadly rounded apices. Valves broad in relation to their length. Central larger interspace present; central nodule visible with LM (cleaned valves mounted in a medium of a high refractive index). Transverse interstriae more curved in smaller than in larger specimens. Stria structure not resolved with LM.

2. Apical axis isopolar; apices more or less rounded.

***Fragilariopsis oceanica* (Cleve) Hasle (Plate 67, Table 73)**

**Basionym:** *Fragilaria oceanica* Cleve.

**Synonyms:** *Fragilaria arctica* Grunow in Cleve & Grunow; *Nitzschia grunowii* Hasle.

**References:** Cleve, 1873b, p. 22, Plate 4, Fig. 25; Cleve & Grunow, 1880, p. 110, Plate 7, Fig. 124; Hustedt, 1959, p. 148, Fig. 662; Hasle, 1965a, p. 11, Plate 1, Figs. 15–19, Plate 2, Figs. 6 and 7; Hasle, 1972c, p. 115; Hasle & Medlin, 1990b, p. 181, Plate 24.1, Figs. 15–19.

**Girdle view:** Cells in straight or sometimes curved ribbons; no interspace between valves of sibling cells. Pervalvar axis often high compared to that of the other *Fragilariopsis* spp. Mantle fairly deep, better silicified than valve face.

**Valve view:** Largest specimens narrowly elliptical with slightly elongated ends, medium-sized specimens more lanceolate with rounded ends, and

---

**PLATE 67** *Fragilariopsis ritscheri*: valves showing size variation, striation, and heteropolarity. *Fragilariopsis atlantica*: valves showing size variation, slight heteropolarity, striation, and central interspace. *Fragilariopsis oceanica*: (a) ribbon with resting spores; (b) valves showing size variation and isopolarity. *Fragilariopsis pseudonana*: Valves showing size variation, striation, and isopolarity. Scale bars = 10  $\mu\text{m}$ .



smallest specimens broadly elliptical. Interstriae on valve face weakly silicified, more strongly silicified on valve mantle. Raphe along the bend between valve face and mantle or slightly displaced to the mantle; central larger interspace present. Structure of striae not resolved with LM. Resting spore valves structured as vegetative valves but heavily silicified.

*Fragilariopsis pseudonana* (Hasle) Hasle (Plate 67, Table 73)

**Basionym:** *Nitzschia pseudonana* Hasle.

**Synonyms:** *Fragilaria nana* Steemann Nielsen in Holmes, 1956, *pro parte*; *Fragilariopsis nana* (Stemann Nielsen) Paasche.

**References:** Holmes, 1956, p. 47, Fig. 17 *pro parte*; Paasche 1961, p. 201, Fig. 1a, Plate 1, Fig. a; Hasle, 1965a, p. 22, Plate 1, Figs. 7–14, Plate 4, Figs. 20 and 21; Hasle, 1974, p. 427; Hasle & Medlin, 1990b, p. 181, Plate 24.1, Figs 7–14; Hasle, 1993, p. 317.

**Valve view:** Largest (ca. 15–20  $\mu\text{m}$ ) specimens narrowly elliptical and smaller specimens more lanceolate with more or less rounded ends.

Interstriae straight in middle part of the valves and curved closer to the apices. Fibulae and interstriae, but not stria, structure resolved with LM. No central larger interspace.

**Remarks:** Since *Fragilaria nana* Steemann Nielsen, basionym of *Fragilariopsis nana* (Stemann Nielsen) Paasche, is synonymous with *Fragilariopsis cylindrus*, the name *Fragilariopsis nana* cannot be used. No type was indicated for either *Fragilariopsis pseudonana* (Hasle, 1965a) or for *Nitzschia pseudonana* (Hasle, 1972c, p. 115); the first valid name is therefore *Nitzschia pseudonana* Hasle in Hasle (1974).

3. Apical axis isopolar; apices generally pointed.

*Fragilariopsis rhombica* (O'Meara) Hustedt (Plate 68, Table 73)

**Basionym:** *Diatoma rhombica* O'Meara.

**Synonym:** *Nitzschia angulata* Hasle.

**References:** O'Meara, 1877, p. 55, Plate 1, Fig. 2; Hustedt, 1952, p. 296, Figs. 6 and 7; Hustedt, 1958a, p. 163, Figs. 113–120; Hustedt, 1958b, p. 205, Figs. 8–11; Hasle, 1965a, p. 24, Plate 9, Figs. 1–6; Hasle, 1972c, p. 115; Hasle & Medlin, 1990b, p. 181, Plate 24.1, Fig. 6, Plate 24.2, Fig. 19, Plate 24.4, Figs. 1–6.

**Valve view:** Largest and medium-sized specimens either lanceolate or linear with parallel margins tapering toward pointed ends and smallest specimens almost circular. Valves broad in relation to their length.

Interstriae straight in the middle linear or convex part of the valve and curved in the tapering parts. Striae with two alternating rows of poroids discernible with LM. No central larger interspace.

Fragilariopsis

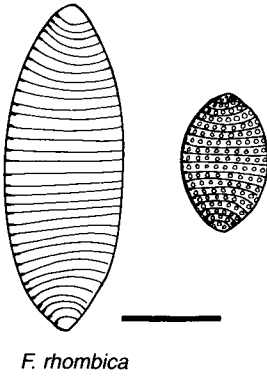

*F. rhombica*

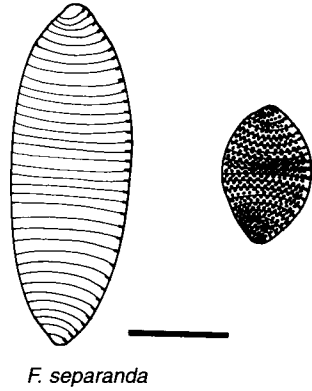

*F. separanda*

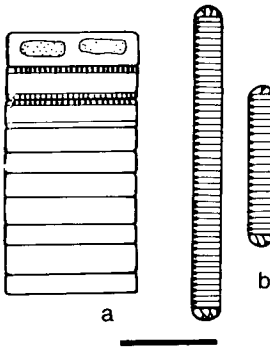

*F. cylindrus*

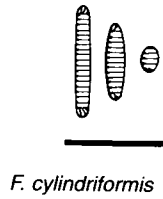

*F. cylindriformis*

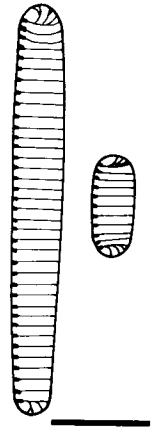

*F. curta*

PLATE 68 *Fragilariopsis rhombica*: two valves of different size, biserial striae indicated in smaller valve. *Fragilariopsis separanda*: two valves, uniserial striae indicated in smaller valve. *Fragilariopsis cylindrus*: (a) ribbon in girdle view, chloroplasts in top cell; (b) valves showing size variation. *Fragilariopsis cylindriformis*: valves showing variation in size and outline. *Fragilariopsis curta*: valves of different size and heteropolarity. Scale bars = 10  $\mu$ m.

***Fragilariopsis separanda* Hustedt (Plate 68, Table 73)**

**Synonym:** *Nitzschia separanda* (Hustedt) Hasle.

**References:** Hustedt, 1958a, p. 165, Figs. 108–112; Hustedt, 1958b, p. 207, Figs. 18 and 19; Hasle, 1965a, p. 26, Plate 9, Figs. 7–10; Hasle, 1972c, p. 115; Hasle & Medlin, 1990b, p. 181, Plate 24.4, Figs. 7–10.

**Valve view:** Larger (25–30  $\mu\text{m}$ ) specimens broadly linear with pointed ends and smaller specimens elliptical to lanceolate. Transverse striae with one row of poroids. Otherwise as described for *F. rhombica*.

B. Valves linear to sublinear.

1. Apical axis isopolar.

***Fragilariopsis cylindrus* (Grunow) Krieger in Helmcke & Krieger (Plate 68, Table 73)**

**Basionym:** *Fragilaria cylindrus* Grunow in Cleve.

**Synonym:** *Nitzschia cylindrus* (Grunow) Hasle.

**References:** Grunow in Cleve & Möller, 1882, No. 314; Cleve, 1883, p. 484, Plate 37, Figs. 64a–64c; Helmcke & Krieger, 1954, p. 17, Plate 187; Hustedt, 1958a, p. 162, Figs. 145 and 146; Hustedt, 1959, p. 152, Fig. 665; Hasle, 1965a, p. 34, Plate 12, Figs 6–12; Hasle, 1968c, Fig. 6; Hasle, 1972c, p. 115; Hasle & Medlin, 1990b, p. 181, Plate 24.6, Figs. 6–12, Plate 24.8, Figs. 11–13.

**Girdle view:** Cells rectangular; perivalvar axis fairly short. Cells in ribbons with no interspace between valves of sibling cells.

**Valve view:** Straight, parallel margins; broadly rounded, almost semicircular apices. Transverse interstriae straight in the rectangular part of the valve; oblique ribs from the last interstria toward the rounded apex usually too weakly silicified to be resolved with LM. Distinction between fibulae and interstriae readily seen with LM. No central larger interspace. Stria structure not resolved with LM.

***Fragilariopsis cylindriiformis* (Hasle, in Hasle & Booth) Hasle (Plate 68, Table 73)**

**Basionym:** *Nitzschia cylindroformis* Hasle in Hasle & Booth.

**References:** Booth et al., 1982, Figs. 7–12 as *N. cylindrus*; Hasle & Booth, 1984; Hasle & Medlin, 1990b, p. 181, Plate 24.8, Figs. 4–10; Hasle, 1993, p. 316.

**Girdle view:** Cells in ribbons with no interspace between valves of sibling cells.

**Valve view:** Largest specimens linearly oblong (similar to *F. cylindrus*), medium-sized specimens narrowly elliptical to lanceolate (like *F.*

*pseudonana*), and the smallest specimens broadly elliptical to subcircular. Fibulae and interstriae resolved with LM with fibulae more distinct than interstriae. Interstriae parallel and straight, except close to the poles. No central larger interspace.

2. Apical axis heteropolar.

***Fragilariopsis curta*** (Van Heurck) Hustedt (Plate 68, Table 73)

**Basionym:** *Fragilaria curta* Van Heurck.

**Synonym:** *Nitzschia curta* (Van Heurck) Hasle.

**References:** Van Heurck, 1909, p. 24, Plate 3, Fig. 37; Hustedt, 1958a, p. 160, Figs. 140–144, 159; Hustedt, 1958b, p. 201, Figs. 2–4; Hasle, 1965a, p. 32, Plate 12, Figs. 2–5; Hasle, 1972c, p. 115; Hasle & Medlin, 1990b, p. 181, Plate 24.6, Figs. 2–5.

**Valve view:** Apical axis heteropolar with one pole slightly narrower than the other. Valve margins more or less parallel, tapering toward the narrower of the two broadly rounded poles. Interstriae and fibulae readily observed with LM; fibulae coarser than interstriae. Interstriae straight in middle part of valve and curved near the poles with some additional apical ribs, these ribs as well as stria structure just visible with LM. No central larger interspace.

C. Valves semilanceolate.

***Fragilariopsis doliolus*** (Wallich) Medlin & Sims (Plate 69)

**Basionym:** *Synedra doliolus* Wallich.

**Synonym:** *Pseudoeunotia doliolus* (Wallich) Grunow in Van Heurck.

**References:** Wallich, 1860, p. 48, Plate 2, Fig. 19; Van Heurck, 1880–1885, Plate 35, Fig. 22; Cupp, 1943, p. 190, Fig. 140; Hustedt, 1958b, p. 199, Fig. 1; Hustedt, 1959, p. 259, Fig. 737; Hasle, 1972c, Fig. 9; Hasle 1976a, Figs. 29–31; Medlin & Sims, 1993.

**Girdle view:** Cells rectangular in broad girdle view, united into curved ribbons by the valve surfaces; no interspace between sibling cells. Open bands, three unperforated and one with one row of perforations (Medlin & Sims, 1993). Chloroplasts—two plates, one on either side of the median transapical plane.

**Valve view:** Valves semilanceolate with bluntly rounded ends. One side of valve (ventral) straight and seldom slightly convex; the other side (dorsal) more strongly convex, gradually decreasing toward the ends, and near the ends often slightly constricted. Transverse striae with two alternating rows of poroids (LM). Interstriae thickened vertically on external and internal surfaces of valve face and mantle (SEM). Canal raphe (SEM)

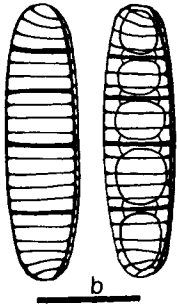
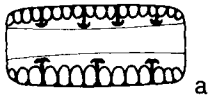

*Neodenticula seminae*

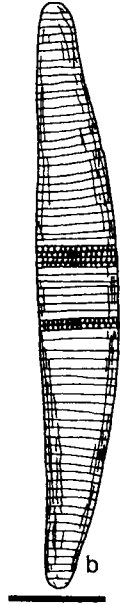
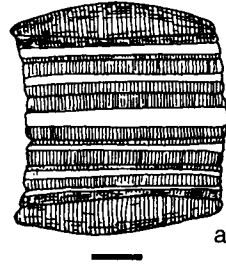

*Fragilariopsis dotiulus*

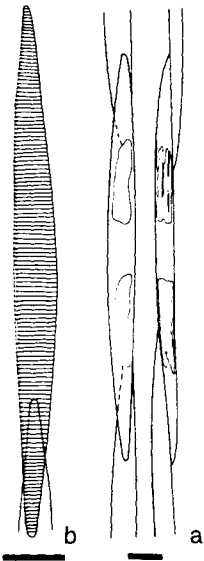

*Pseudo-nitzschia seriata* f. *seriata*

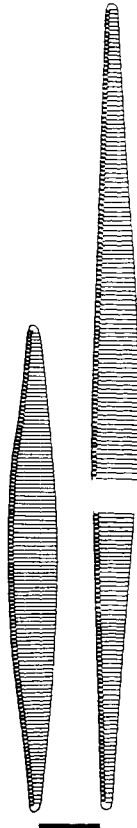

*P. australis*

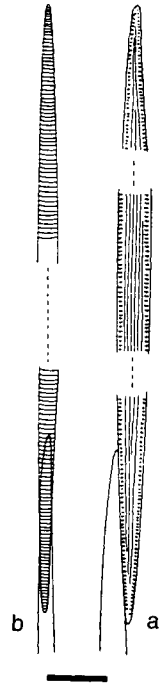

*P. pungens*

along bend between valve face and mantle, along either dorsal or ventral side, indicating a diagonal location of the raphe systems on the frustule. Some irregularities between the middle fibulae observed with LM and SEM.

**Remarks:** SEM investigations (Hasle, 1976a) confirmed Hustedt's (1958b) LM observation of a canal raphe in *F. doliolus*; central raphe endings, reported by Hustedt, were not seen (see also Medlin & Sims, 1993). The expressed curvature giving the ribbons the appearance of a section of a barrel may be due to a more shallow valve mantle along the straight rather than the curved valve margin.

**Distribution:**

*F. kerguelensis*, *F. ritscheri*, *F. rhombica*, and *F. separanda*—southern cold water region, plankton.

*F. atlantica* and *F. cylindriciformis*—northern cold water region, plankton.

*F. doliolus*—warm water region.

*F. pseudonana*—cosmopolitan, plankton.

*F. curta*—southern cold water region, plankton and ice.

*F. oceanica*—northern cold water region, plankton and ice(?).

*F. cylindrus*—southern and northern cold water regions, plankton and ice.

*Fragilariopsis kerguelensis* is particularly abundant in the southern ocean but has been recorded as far north as the Cape Verde Islands (Heiden & Kolbe, 1928).

**How to identify:** *Fragilariopsis doliolus* is readily identified in colonies and as single cells in water mounts due to the unique shape of the ribbons and the valve outline. *Fragilariopsis kerguelensis* may be discriminated from other planktonic species by its coarse silification, also when observed in girdle view. The other planktonic species have to be examined in valve view to secure a positive identification. Material cleaned of organic matter and mounted in a medium of a high refractive index may be required.

**Genus *Neodenticula*** Akiba & Yanagisawa 1986

**Type:** *Neodenticula kamtschatica* (Zabelina) Akiba & Yanagisawa.

**Basionym:** *Denticula kamtschatica* Zabelina.

---

**PLATE 69** *Neodenticula seminae*: (a) single cell in girdle view with pseudosepta; (b) valves with striation and pseudosepta and valve with attached band. After Simonsen & Kanaya (1961). *Fragilariopsis doliolus*: (a) ribbon in broad girdle view; (b) valve with striation and areolae indicated. After Cupp (1943). *Pseudo-nitzschia seriata* f. *seriata*: (a) stepped chains in valve and girdle views; (b) valve view. From Hasle (1972d). *Pseudo-nitzschia australis*: valves of different size. From Hasle (1972d). *Pseudo-nitzschia pungens*: partial chains in (a) girdle view and (b) valve view. From Hasle (1972d). Scale bars = 10  $\mu\text{m}$ .

Terminology specific to *Neodenticula*:

**Pseudoseptum**—diaphragm-like ingrowth of valve, in this genus shaped as a vertical wall penetrating into the cell interior and separating the lumen of the valve into chambers.

*Neodenticula seminae* (Simonsen & Kanaya) Akiba & Yanagisawa (Plate 69)

**Basionym:** *Denticula seminae* Simonsen & Kanaya.

**Synonyms:** *Denticula marina* Semina; *Denticulopsis seminae* (Simonsen & Kanaya) Simonsen.

**References:** Semina, 1956, p. 82, Figs. 1 and 2; Simonsen & Kanaya, 1961, p. 503, Plate 1, Figs. 26–30; Hasle, 1972c, Figs. 3, 4, and 8; Simonsen, 1979, p. 65; Semina, 1981b; Akiba & Yanagisawa, 1986, p. 491, Plate 24, Figs. 1–11, Plate 26, Figs. 1–10; Yanagisawa & Akiba, 1990, p. 263, Plate 7, Figs. 45–49; Medlin & Sims, 1993, Figs. 13–21.

**Girdle view:** Cells rectangular with rounded corners, interstriae, and strong pseudosepta, the latter widening toward cell interior. Bands septate.

**Valve view:** Valves linear to elliptical, usually with broadly rounded ends. Valve surface with transverse striae, the areolation of the striae usually too fine to be resolved with LM. Pseudosepta seen as sharp, distinct lines with focus on external valve surface and as wide crossbars with focus on their distal parts; both ends of a crossbar connected with the thick valve wall by a suture. Pseudosepta sometimes short in peralvar direction and without crossbars. A varying number of striae between two pseudosepta. One interstria often branched into two fibulae (SEM). Raphe continuous along the edge of valve face scarcely discernible with LM. Raphe systems of the two valves on opposite sides of the frustule.

**Morphometric data:** Apical axis, 10–60  $\mu\text{m}$ , transapical axis, 4–9  $\mu\text{m}$ ; pseudosepta, 2–4 in 10  $\mu\text{m}$ ; 1–4 striae and interstriae between two pseudosepta and 8–12(?) fibulae in 10  $\mu\text{m}$ .

**Distribution:** Common in North Pacific Ocean, also reported from tropical parts of the Indian and Pacific Oceans (Semina, 1981b).

**How to identify:** The species may be identified as whole cells in water mounts.

**Remarks:** Controversial opinions exist concerning the crossbars being parts of the pseudosepta and thus of the valves or of the valvocopula septum. Based on our own published and unpublished observations we agree with Simonsen (1979) and Akiba & Yanagisawa (1986) that although the bands are septate, the crossbars do belong to the pseudosepta. Another peculiarity is the presence of open and closed bands in *N. seminae* (Hasle, 1972c, Fig. 4; Akiba & Yanagisawa, 1986, Plate 24, Figs. 6 and 7, Plate 26, Figs. 7 and 8; Yanagisawa & Akiba, 1990, Plate 7, Fig. 49; Medlin & Sims, 1993, Figs. 15, 16, 20, and 21). Medlin & Sims (1993) suggested that the closed bands might be more commonly associated with valves with deeper pseudosepta.

Genus *Pseudo-nitzschia* H. Peragallo in H. & M. Peragallo

Lectotype: *Pseudo-nitzschia seriata* (Cleve) H. Peragallo (in H. & M. Peragallo, 1897–1908) (*vide* Fryxell et al., 1991, p. 243).

The genus was erected for *Nitzschia sicula* with the varieties *bicuneata* and *migrans*, and *Nitzschia seriata* with the variety *fraudulenta*—all pelagic forms with obscure keels (“carènes très obscures”), if present at all (H. & M. Peragallo, 1897–1908, p. 263). *Pseudo-nitzschia seriata* was furthermore characterized by a fine striation and cells in long filaments, and *N. sicula* by coarser striation and cells probably free living. The raphe system of *Pseudo-nitzschia* as revealed with EM is like that of *Fragilariopsis*, not being elevated above the general level of the valve, and lacking conopea and lacking poroids in the external canal wall. Some of the species have striae with two rows of poroids like *Fragilariopsis*, whereas others have more than two rows and still others have only one row. Some *Pseudo-nitzschia* species are rectangular in girdle view like *Fragilariopsis*, but many are fusiform, and in valve view in general longer and narrower than *Fragilariopsis*. The distinction between the two genera is especially manifest in the stepped colonies and in the tendency of heteropolarity of the transapical axis of *Pseudo-nitzschia*. The girdle structure may be a third distinctive character. The intercalary bands of *Pseudo-nitzschia* are open, distinctly pointed, narrow, and mostly striated. The striae are similar in structure to those on the valve with one or more rows of poroids (Hasle, 1965b; Hasle et al., 1995). This type of band structure together with other morphological characters such as the structure of the raphe system, characterize *Pseudo-nitzschia* as a natural group separate from *Nitzschia* (Hasle, 1994).

*Pseudo-nitzschia* is a geographically widely distributed genus (Hasle, 1965b, 1972d) restricted to marine plankton. More detailed studies of the distribution of taxa referred to *Pseudo-nitzschia* spp. are of special interest, however, since *P. multiseriata* is well established as being capable of producing the neurotoxin, domoic acid, in growth-limiting conditions in stationary stage. This has been reported from at least two areas with different climatic and hydrographic conditions (Bates et al., 1989; Fryxell et al., 1990). Domoic acid was also detected in clams and mussels in the Bay of Fundy, eastern Canada, at a time when *P. pseudodelicatissima* was the predominant phytoplankton species (Martin et al., 1990), and *P. australis* has been documented as a producer of domoic acid in California waters (Buck et al., 1992; Garrison et al., 1992). *Pseudo-nitzschia delicatissima* and *P. seriata* have been shown to produce domoic acid in cultures (Smith et al., 1991; Lindholm et al., 1994). Domoic acid may be a worldwide threat, on temperate coasts at least, but action can be taken to alleviate the potential danger by monitoring the phytoplankton and utilizing temporary closings of selected fisheries in target areas when necessary for the duration of a bloom.



Generic characters:

- Cells strongly elongate, rectangular, or fusiform in girdle view.
- Cells in stepped chains united by shorter or longer overlap of valve ends.
- Chains motile.
- Raphe strongly eccentric.
- Raphe not raised above the general level of the valve.
- Valve face interstriae often more than one to each fibula.
- Central larger interspace in most species.
- Valve face slightly curved or flattened, not undulated.
- Valve narrowly lanceolate to fusiform and linear with rounded or pointed ends.
- Transapical axis heteropolar in some species.
- Stria structure usually too delicate to resolve with LM.
- Chloroplasts—two plates, lying along the girdle, one on either side of the median transapical plane.
- Resting spores unknown.

Characters showing differences between species:

- Valve outline.
- Width of valve (= length of transapical axis).
- Polarity of transapical axis.
- Linear density of interstriae versus fibulae.
- Size of central interspace.
- Shape of valve ends in girdle and valve views.
- Length of overlap of cell ends.

KEY TO SPECIES (based on light microscope observations)

- 1a. Transapical axis wider than 3  $\mu\text{m}$  . . . . .2
- 1b. Transapical axis narrower than 3  $\mu\text{m}$ . . . . .9
- 2a. Central larger interspace present . . . . .3
- 2b. Central larger interspace absent. . . . .6
- 3a. Outline of valve asymmetrical in the apical axis; one margin almost straight, the other curved. . . . .4
- 3b. Outline of valve symmetrical in the apical axis . . . . .5
- 4a. Fibulae and interstriae discernible with the light microscope . *P. heimii*
- 4b. Fibulae but not interstriae discernible with the light microscope . . . . .  
. . . . . *P. subpacific*

- 5a. Valve outline lanceolate; margins not parallel; fibulae and interstriae equal in number . . . . . *P. fraudulenta*
- 5b. Valve outline with parallel margins for the greater part of the valve length; fibulae and interstriae unequal in number . . . *P. subfraudulenta*
- 6a. Outline of valve asymmetrical in the apical axis; one margin almost straight, the other curved. . . . . *P. seriata*
- 6b. Outline of valve symmetrical in the apical axis . . . . . 7
- 7a. The presence of poroids in the striae discernible with the light microscope . . . . . *P. pungens*
- 7b. The presence of poroids in the striae not discernible with the light microscope . . . . . 8
- 8a. Transapical axis wider than 5  $\mu\text{m}$ ; valve apices rostrate; outline of smaller valves tends to be asymmetrical in the apical axis . . . . . *P. australis*
- 8b. Transapical axis narrower than 5  $\mu\text{m}$ ; valve outline lanceolate with pointed (not rostrate) apices . . . . . *P. multiseriata*
- 9a. Central larger interspace present . . . . . 10
- 9b. Central larger interspace absent, valve with prolonged projections (rostrate). . . . . 17
- 10a. Valve inflated in the middle . . . . . 11
- 10b. Valve otherwise. . . . . 14
- 11a. Valve with prolonged projections. . . . . *P. prolongatoides*
- 11b. Valves otherwise . . . . . 12
- 12a. Valves slightly inflated before tapering ends, interstriae not discernible with the light microscope. . . . . *P. inflatula*
- 12b. Valve ends obtuse, interstriae distinct . . . . . 13
- 13a. Valves comparatively wide (length ca. 12–30 times width), valve ends broadly obtuse . . . . . *P. turgidula*
- 13b. Valves narrow (length ca. 27–60 times width) . . . . . *P. turgiduloides*
- 14a. Valves comparatively wide (ca. 3  $\mu\text{m}$ ) and tapering parts of valves long . . . . . *P. cuspidata*
- 14b. Valves otherwise . . . . . 15
- 15a. Valves slightly lanceolate, fibulae and central larger interspace barely visible with the light microscope, interstriae not visible. . . . . *P. delicatissima*
- 15b. Valves linear, tapering parts of valves short . . . . . 16
- 16a. Fibulae and central larger interspace clearly visible with the light microscope, interstriae also occasionally visible . . . . . *P. pseudodelicatissima*
- 16b. Fibulae and interstriae clearly visible with the light microscope. . . . . *P. lineola*
- 17a. One valve margin straight or slightly concave, the other convex, especially in the middle part of the valve . . . . . *P. subcurvata*
- 17b. Valve narrow, lanceolate to needle shaped. . . . . *P. granii*

The species may also be grouped according to numerical data, shape of valves and stria structure, the latter mainly revealed with TEM.

- A. Valves fairly wide compared to length (transapical axis ca. 3  $\mu\text{m}$  or more).
  - 1. Approximately equal numbers of fibulae and interstriae; fibulae therefore often indistinct; no central larger interspace: *P. seriata*, *P. australis*, *P. pungens*, and *P. multiseries* (Table 74).
  - 2. Slightly more interstriae than fibulae; central larger interspace present: *P. pungiformis*, *P. fraudulenta*, and *P. subfraudulenta* (Table 74).
  - 3. More than one interstria per fibula; central larger interspace present; transapical axis heteropolar: *P. heimii* and *P. subpacificica* (Table 74).
- B. Valves narrow compared to cell length (transapical axis ca. 3  $\mu\text{m}$  or less); approximately two interstriae for each fibula.
  - 1. Circular poroids.  
Central larger interspace present: *P. delicatissima*, *P. lineola*, *P. prolongatoides*, *P. turgidula*, and *P. turgiduloides* (Table 75).
  - 2. Square poroids.
    - a. Central larger interspace present: *P. cuspidata*, *P. pseudodelicatissima*, and *P. inflatula* (Table 75).
    - b. No central larger interspace: *P. granii* and *P. subcurvata* (Table 75).

A. Transapical axis ca. 3  $\mu\text{m}$  or more.

This group of larger (= wider in valve view) *Pseudo-nitzschia* species has been called the “*Nitzschia seriata* complex” (Hasle, 1965b). They all have a tendency to appear in girdle view in water mounts, and with *P. pungens* as the only possible exception, the distinction between species can only be seen in valve view. *Pseudo-nitzschia seriata* seems for some obscure reasons to have been regarded by many planktonologists as the only species of this size group appearing in stepped chains. The whole group may have been identified as “*Nitzschia seriata*” on many occasions, and the numerous records of *N. seriata* from all oceans should be regarded with scepticism.

- 1. Approximately equal numbers of interstriae and fibulae; no central larger interspace.

*Pseudo-nitzschia seriata* (Cleve) H. Peragallo in H. & M. Peragallo f. *seriata* (Plate 69, Table 74)

**Basionym:** *Nitzschia seriata* Cleve.

**References:** Cleve, 1883, p. 478, Fig. 75; H. & M. Peragallo, 1897–1908, p. 300, Plate 72, Fig. 28; Cupp, 1943, p. 201, Fig. 155; Hasle, 1965b, p. 8, Plate 1, Fig. 1, Plate 3, Figs. 1–7 and 10; Hasle & Medlin, 1990c,

TABLE 74 Morphometric Data of *Pseudo-nitzschia* spp. of the "Nitzschia seriata Complex" (Hasle, 1965b, 1971)

Species	Apical axis ( $\mu\text{m}$ )	Transapical axis ( $\mu\text{m}$ )	Striae in 10 $\mu\text{m}$	Fibulae in 10 $\mu\text{m}$
Group A1				
<i>P. seriata</i> f. <i>seriata</i>	91–160	5.5–8	14–18	14–18
<i>P. seriata</i> f. <i>obtusa</i>	61–100	4.5–5.3	15–20	15–20
<i>P. australis</i>	75–144	6.5–8	12–18	12–18
<i>P. pungens</i>	74–142	3–4.5	9–15	9–15
<i>P. multiseriata</i>	68–140	4–5	10–13	10–13
Group A2				
<i>P. pungiformis</i>	96–145	4–5	14–20	12–18
<i>P. fraudulenta</i>	64–111	4.5–6.5	18–24	12–24
<i>P. subfraudulenta</i> <sup>a</sup>	65–106	5–7	23–26	14–17
Group A3				
<i>P. heimii</i>	67–120	4–6	19–26	11–16
<i>P. subpacifici</i>	33–70	5–7	28–32	15–20

<sup>a</sup> Mentioned in the text for comparison.

p. 169, Plate 22.1, Figs 1–7 and 10; Hasle, 1994, Fig. 3; Hasle et al., 1995, Figs. 10–14 and 45–49.

**Girdle view:** Linear to fusiform with distinctly pointed ends; overlap of cells in chains one-third to one-fourth of cell length.

**Valve view:** One margin of middle part almost straight and the other convex; both margins tapering toward more or less rounded apices.

Interstriae of well-silicified specimens discernible in water mounts and readily seen on cleaned valves on permanent mounts. Canal raphe along either curved or straight margin.

***Pseudo-nitzschia seriata* f. *obtusa* (Hasle) Hasle**

**Basionym:** *Nitzschia seriata* f. *obtusa* Hasle.

**References:** Hasle, 1965b, p. 10, Plate 3, Figs. 8, 9, and 11; Hasle, 1974, p. 426; Hasle & Medlin, 1990c, p. 169, Plate 22.1, Figs. 8, 9, and 11; Hasle 1993, p. 319; Hasle et al., 1995, Figs. 15 and 50.

**Valve view:** Same as the nominate form but smaller and with distinctly rounded apices. Specimens in which the valve structure is not resolved may be confused with *Thalassionema nitzschioides*.

***Pseudo-nitzschia australis* Frenguelli (Plate 69, Table 74)**

**Synonym:** *Nitzschia pseudoseriata* Hasle.

**References:** Frenguelli, 1939, p. 217, Plate 2, Fig. 13; Hasle, 1965b, p. 11, Plate 5, Figs. 1–6, Plate 6, Fig. 1; Rivera, 1985, p. 13, Figs. 14–18; Hasle et al., 1995, Figs. 16 and 51–54.

**Girdle view:** Fusiform; overlap of cells in chains ca. one fourth of cell length (Rivera, 1985, Figs. 15 and 16). Bands strongly silicified with transverse ribs somewhat more closely spaced than those on the valves (Hasle, 1965b, Plate 5, Fig. 6).

**Valve view:** Larger (apical axis more than ca. 100  $\mu\text{m}$ ) specimens with slightly rostrate ends. Middle, about one third part of valve with more or less parallel margins, sometimes less distinct in smaller specimens. Fibulae more distinct than interstriae, both readily seen with LM.

**Remarks:** Rivera (1985) rejected *Nitzschia pseudoseriata* (= *P. australis*) as a taxon of its own, separated from *Nitzschia seriata*, his argument being the great variation in his Chilean material. *Pseudo-nitzschia australis* is larger, generally coarser, and more symmetrical with respect to the apical plane than *P. seriata*. Also, the valve striae of *P. australis* bear two rows of poroids and those of *P. seriata* three or four, and the poroids of *P. australis* are larger than those of *P. seriata* (Hasle, 1965b; Hasle et al., 1995).

***Pseudo-nitzschia pungens*** (Grunow ex Cleve) Hasle (Plate 69, Table 74)

**Basionym:** *Nitzschia pungens* Grunow ex Cleve.

**References:** Grunow (in Cleve & Möller, 1882), No.307; Cleve, 1897a, p. 24, Plate 2, Fig. 23; Cupp, 1943, p. 202, Fig. 156; Hasle, 1965b, p. 12, Plate 1, Figs. 4 and 5, Plate 5, Figs. 7–9; Takano & Kuroki, 1977, p. 42, Figs. 1 and 4–8; Rivera, 1985, p. 12, Figs. 1–3; Takano & Kikuchi, 1985; Takano, 1990, pp. 328–329; Hasle, 1993, p. 319; Hasle et al., 1995, Figs. 3–6 and 30–37; Hasle, 1995, Fig. 1.

**Girdle view:** Fusiform, perivalvar axis up to 8  $\mu\text{m}$ . Fibulae and/or ends of interstriae distinct. Overlap of cells in chains considerable, close to one-third or more of cell length.

**Valve view:** Larger specimens linear with distinctly pointed ends, and smaller specimens more fusiform. Strongly silicified. Interstriae visible in water mounts. Fibulae distinct on cleaned valves on permanent mounts; striae biseriolate; the two rows of poroids discernible with LM under optimum optical conditions (phase contrast, oil immersion).

***Pseudo-nitzschia multiseriata*** (Hasle) Hasle (Table 74)

**Basionym:** *Nitzschia pungens* f. *multiseriata* Hasle.

**Synonym:** *Pseudo-nitzschia pungens* f. *multiseriata* (Hasle)

**References:** Hasle, 1965b, p. 14, Plate 2, Figs. 1 and 2, Plate 5, Figs. 10–12; Hasle, 1974, p. 426; Takano & Kuroki, 1977, p. 43, Figs. 2 and 9–13; Subba Rao & Wohlgeschaffen, 1990; Fryxell et al., 1990, p. 171; Takano, 1990, pp. 328–329; Hasle, 1993, p. 319; Hasle et al., 1995, Figs. 7–9 and 38–44; Hasle, 1995, Fig. 2; Manhart et al., 1995.

**Valve view:** Multiseriate striae, not resolved with LM. Smaller and medium-sized specimens on an average broader compared to valve length than same sized specimens of the nominate form.

**Remarks:** Since the poroids do not resolve with LM, EM is necessary to ascertain the identification of this species. Takano & Kikuchi (1985) reported on *P. pungens* cells with swellings from the girdle and undulated valves from eutrophic marine Japanese waters. Subba Rao & Wohlgeschaffen (1990) found similar cells of *P. multiseriis* in cultures and in naturally very dense populations. Beaked and lobed valve margins, such as those shown in these investigations, are common in dense, unhealthy cultures of *Pseudo-nitzschia* in general (Hasle, 1965b, Plate 2, Fig. 9) and are also comparable to the forms of *Synedropsis hyperborea* found in nature (Grunow, 1884, Plate 2, Figs. 4–6) and in cultures (Hasle et al., 1994). The occurrence of aberrant cells of *P. multiseriis* should be no obstacle for a correct identification since the cells retain most of their specific morphological characters.

2. Slightly more interstriae than fibulae; central larger interspace present.

*Pseudo-nitzschia pungiformis* (Hasle) Hasle (Table 74)

**Basionym:** *Nitzschia pungiformis* Hasle.

**References:** Hasle, 1971, p. 143, Figs. 1–8; Simonsen, 1974, p. 54, Plate 40, Figs. 1 and 2; Hasle, 1993, p. 319.

**Valve view:** Larger specimens with almost parallel margins for their greater length; smaller specimens fusiform, valve ends slightly pointed. Fibulae, interstriae, and the central larger interspace readily recognized on cleaned valves on permanent mounts (LM). Number of fibulae and interstriae generally the same in the middle part of the valve with a slight deviation toward the valve ends. The biseriate structure of the striae not resolved with LM.

*Pseudo-nitzschia fraudulentata* (Cleve) Hasle (Plate 70, Table 74)

**Basionym:** *Nitzschia fraudulentata* Cleve.

**Synonym:** *Pseudo-nitzschia seriata* var. *fraudulentata* (Cleve) H. Peragallo in H. & M. Peragallo.

**References:** Cleve, 1897b, p. 300, Fig. 11; H. & M. Peragallo, 1897–1908, p. 300, Plate 72, Fig. 29; Hasle, 1965b, p. 15, Plate 1, Figs. 2 and 3, Plate 6, Figs. 5–10; Takano & Kuroki, 1977, p. 43, Figs. 14–18; Rivera, 1985, p. 15, Figs. 43–46; Hasle, 1993, p. 318; Hasle, 1994, Fig. 4; Hasle et al., 1995, Figs. 17–19 and 57–61.

**Girdle view:** Linear to fusiform; overlap of cells in chains fairly short.

**Valve view:** Fusiform. Weakly silicified; valve structure not discernible in water mounts. Fibulae and central nodule distinct on cleaned valves on permanent mounts; interstriae barely discernible (LM).

**Remarks:** *Pseudo-nitzschia subfraudulentata* (Hasle) Hasle (basionym: *Nitzschia subfraudulentata*) is a less frequently recorded species which is very

*Pseudo-nitzschia*

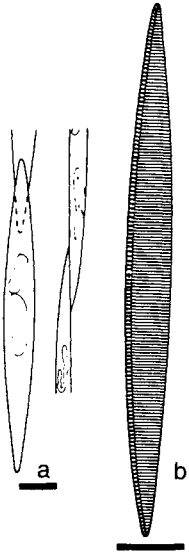

*P. fraudulenta*

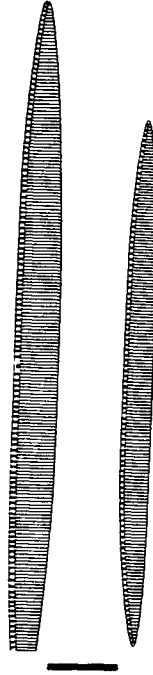

*P. subfraudulenta*

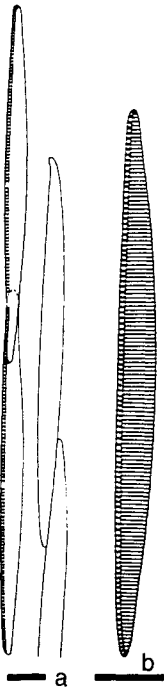

*P. heimii*

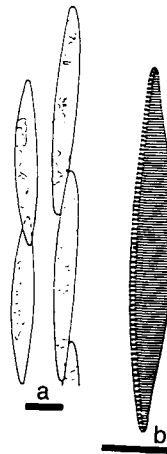

*P. subpacificica*

similar to *P. fraudulenta* but differs in morphometric data and by having more linear valves, especially in the middle part (Hasle et al., 1995, Fig. 62).

3. More than one interstria per fibula; central larger interspace present; transapical axis heteropolar; canal raphe along either convex or straight margin.

***Pseudo-nitzschia heimii* Manguin (Plate 70, Table 74)**

**Synonym:** *Nitzschia heimii* (Manguin) Hasle.

**References:** Manguin, 1957, p. 131, Plate 6, Fig. 42; Manguin, 1960, p. 332, Plate 19, Figs. 223 and 224; Hasle, 1965b, p. 21, Plate 1, Figs. 6 and 7, Plate 10, Figs. 9–13; Simonsen, 1974, p. 51, Plate 36, Figs. 4 and 5; Hasle & Medlin, 1990c, p. 169, Plate 22.2, Figs. 9–13; Hasle et al., 1995, Figs. 20 and 65–69.

**Girdle view:** Linear, tapering toward somewhat sigmoid and obliquely truncated poles; overlap of cells in chains one-fourth to one-fifth of cell length.

**Valve view:** Largest specimens almost fusiform; smaller specimens with one convex and one straight margin attenuated toward broadly rounded, obtuse ends, sometimes with a constriction near apices. Fibulae, central larger interspace, central nodule and interstriae readily seen on cleaned valves on permanent mounts (LM).

***Pseudo-nitzschia subpacificica* (Hasle) Hasle (Plate 70, table 74)**

**Basionym:** *Nitzschia subpacificica* Hasle.

**References:** Hasle, 1965b, p. 20, Plate 1, Figs. 9 and 10, Plate 10, Figs. 1–8; Hasle, 1974, p. 427; Simonsen, 1974, p. 55, Plate 41, Figs. 1–3; Hasle, 1993, p. 320.

**Girdle view:** Slightly convex margins; sigmoid, obliquely truncated cell ends; overlap of cells in chains one-fifth to one-sixth of cell length.

**Valve view:** One margin convex, the other more or less straight especially in the middle two-thirds of valve length; valve ends more or less pointed. Canal raphe somewhat indented in the middle; central larger interspace and central nodule observable on cleaned valves on permanent mounts, interstriae barely discernible (LM).

---

**PLATE 70** *Pseudo-nitzschia fraudulenta*: (a) partial chains in valve and girdle views; (b) valve with striation and central larger interspace. *Pseudo-nitzschia subfraudulenta*: valves with striation and central larger interspace. *Pseudo-nitzschia heimii*: (a) partial chains in valve and girdle views; (b) valve with striation and central larger interspace. *Pseudo-nitzschia subpacificica*: (a) partial chains in valve and girdle views; (b) valve with striation and central larger interspace. From Hasle (1972d). Scale bars = 10  $\mu$ m.



**Distribution** (Hasle 1972d):

*P. seriata* f. *seriata*—northern cold water region to temperate.

*P. seriata* f. *obtusata*—northern cold water region.

*P. australis*, *P. subfraudulenta*, and *P. subpacificata*—warm water region to temperate.

*P. pungiformis*—warm water region.

*P. pungens*, *P. multiseries*, *P. fraudulenta*, and *P. heimii*—cosmopolitan.

*Pseudo-nitzschia heimii* is particularly abundant in the subantarctic. The presence of *P. australis* in the north Pacific should be noted (Hasle, 1972d, Fig. 2, confirmed by personal observations of net samples from Monterey Bay, August 7, 1967 and July 14, 1982, and in September 1991 by Work et al., 1991).

**How to identify:** In general, the species of the “*Nitzschia seriata* complex” can only be identified to genus and not to species when examined in girdle view. A few of the larger species are coarsely structured and are identifiable in valve view in water mounts. Most of them have to be examined as cleaned valves mounted in a medium of a high refractive index.

B. Transapical axis ca. 3  $\mu\text{m}$  or less.

With a few exceptions the diatoms of this so-called “*Nitzschia delicatissima* complex” (Hasle, 1965b) are delicate forms with a very fine structure. Electron microscopy reveals two types of stria structure, either well-defined circular

TABLE 75 Morphometric Data of *Pseudo-nitzschia* spp. of the “*Nitzschia delicatissima* Complex” (Hasle, 1964, 1965b)

Species	Apical axis ( $\mu\text{m}$ )	Transapical axis ( $\mu\text{m}$ )	Striae in 10 $\mu\text{m}$	Fibulae in 10 $\mu\text{m}$
Group B1				
<i>P. delicatissima</i>	40–76	ca. 2	36–40	19–25
<i>P. lineola</i>	56–112	1.8–2.7	22–28	11–16
<i>P. prolongatoides</i>	20–70	0.5–2.5	30–35	15–18
<i>P. turgidula</i>	30–80	2.5–3.5	23–28	13–18
<i>P. turgiduloides</i> <sup>a</sup>	63–126	1.2–2.7	17–21	10–13
Group B2				
<i>P. cuspidata</i>	30–80	ca. 3	29?–37 <sup>b</sup>	16?–22
<i>P. inflatula</i> <sup>a</sup>	60–100	1.5–2.5	32–35	18–21
<i>P. pseudodelicatissima</i>	59–140	1.5–2.5	30–46?	16–26
<i>P. granii</i>	25–79	1.5–2.5	44–49	12–18
<i>P. subcurvata</i>	47–113	1.5–2.5	44–49	12–18

<sup>a</sup> Mentioned in the text for comparison.

<sup>b</sup> ?, Data uncertain.

poroids in a varying number of rows or one row of more square poroids. These narrower *Pseudo-nitzschia* species are, like the larger ones, almost indistinguishable in girdle view and have most likely often been confused with *N. delicatissima* as the best known of the complex.

1. Circular poroids; central larger interspace present.

***Pseudo-nitzschia delicatissima*** (Cleve) Heiden in Heiden & Kolbe (Plate 72, Table 75)

**Basionym:** *Nitzschia delicatissima* Cleve.

**Synonym:** *Nitzschia actydropbila* Hasle.

**References:** Cleve, 1897a, p. 24, Plate 2, Fig. 22; Heiden & Kolbe, 1928, p. 672; Hasle, 1965b, p. 35, Plate 2, Fig. 10, Plate 15, Figs. 19–23; Hasle, 1976b, p. 102, Figs 1–5; Hasle & Medlin, 1990c, p. 169, Plate 22.5, Figs. 19–23; Hasle et al., 1995, Figs. 23–25 and 70–75.

**Girdle view:** Linear; cells slightly sigmoid, narrow, and truncated; overlap of cells in chains short (about one-ninth of cell length).

**Valve view:** Spindle shaped with slightly rounded apices. Fibulae and central larger interspaces barely visible with LM. Striae with two rows of poroids (TEM).

**Remarks:** *Pseudo-nitzschia pseudodelicatissima* and *P. delicatissima* are readily distinguished by their stria structure resolved with EM. The distinction is harder to recognize with LM. The more pointed cell ends in girdle view, the more tapering valve ends, and the more linear valve outline of *P. pseudodelicatissima* compared to *P. delicatissima* do help to ascertain the identification of the two species.

***Pseudo-nitzschia lineola*** (Cleve) Hasle (Plate 71, Table 75)

**Basionym:** *Nitzschia lineola* Cleve.

**Synonym:** *Nitzschia barkleyi* Hustedt.

**References:** Cleve, 1897b, p. 300, Fig. 10; Hustedt, 1952, p. 293, Figs. 13 and 14; Hasle, 1965b, p. 29, Plate 12, Figs. 15–19; Simonsen, 1974, p. 53, Plate 39, Figs. 4–6; Hasle & Medlin, 1990c, p. 169, Plate 22.3, Figs. 15–21; Hasle, 1993, p. 319.

**Girdle view:** Linear to slightly lanceolate with pointed, somewhat sigmoid ends; overlap of cell ends in chains one-fifth to one-sixth of cell length.

**Valve view:** Linear with slightly pointed apices. Fibulae coarse; striae with one, and in parts of the valve two, rows of poroids (TEM), punctate when examined with LM.

***Pseudo-nitzschia prolongatoides*** (Hasle) Hasle (Plate 73, Table 75)

**Basionym:** *Nitzschia prolongatoides* Hasle.

**Synonym:** *Nitzschia prolongata* Manguin non *Nitzschia prolongata* Hustedt (see Hasle, 1965b, p. 27).

*Pseudo-nitzschia*

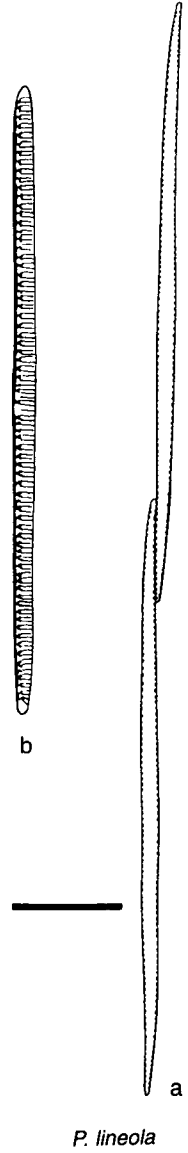
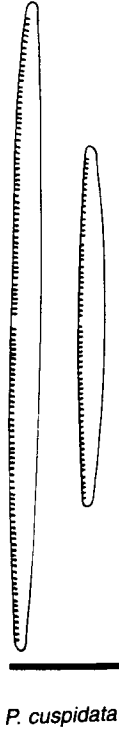
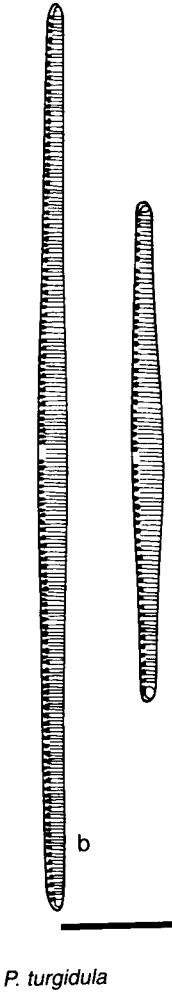

**References:** Manguin, 1957, p. 132, Plate 7, Fig. 46; Hasle, 1965b, p. 25, Plate 2, Fig. 11, Plate 12, Figs. 7 and 8; Hasle & Medlin, 1990c, p. 169, Plate 22.3, Figs. 7 and 8; Hasle, 1993, p. 319.

**Girdle view:** Almost linear, possibly expanded in the middle; overlap of cell ends extremely short (about 1/15 of cell length).

**Valve view:** Expanded middle part occupying about one-third of cell length; rostrate parts with slightly wider apices. Fibulae, central larger interspace with central nodule, and delicate transverse interstriae discernible with LM. Striae with two to three rows of circular poroids resolved with TEM.

***Pseudo-nitzschia turgidula* (Hustedt) Hasle (Plate 71, Table 75)**

**Basionym:** *Nitzschia turgidula* Hustedt.

**References:** Hustedt, 1958a, p. 182, Figs. 172 and 173; Hasle, 1965b, p. 24, Plate 1, Fig. 11, Plate 2, Fig. 3, Plate 12, Figs. 1–6; Hasle & Medlin, 1990c, p. 169, Plate 22.3, Figs. 1–6; Hasle 1993, pp. 320.

**Girdle view:** Margins slightly convex tapering toward truncated cell ends; overlap of cells in chains short, about one-sixth of cell length.

**Valve view:** Larger specimens linear except for a middle expansion; smaller specimens rhomboid to lanceolate with rounded ends. Fibulae and interstriae distinct. Striae with two rows of poroids (TEM).

**Remarks:** Due to the truncated cell ends and the short overlap of cells in chains *P. turgidula* may be identified in girdle view. *Pseudo-nitzschia turgiduloides* (Hasle) Hasle (basionym: *Nitzschia turgiduloides*, synonym: *Pseudo-nitzschia barkleyi* var. *obtusata* Manguin nom. nud.) is a larger and more coarsely structured species similar to *P. turgidula* in shape of cell ends.

2a. Square poroids, central larger interspace present.

***Pseudo-nitzschia cuspidata* (Hasle) Hasle (Plate 71, Table 75)**

**Basionym:** *Nitzschia cuspidata* Hasle.

**References:** Hasle, 1965b, p. 34, Plate 2, Fig. 6, Plate 15, Figs. 9–18; Hasle, 1974, p. 427; Simonsen, 1974, p. 51, Plate 39, Figs. 1–3; Hasle, 1993, p. 318.

**Girdle view:** Linear to slightly lanceolate tapering to narrow, truncated ends; overlap of cells in chains one-fifth to one-sixth of cell length.

**Valve view:** Narrowly lanceolate, tapering parts long; apices narrow with truncated ends. Transapical axis wide compared with other species of this

---

PLATE 71 *Pseudo-nitzschia turgidula*: (a) chain in girdle view; (b) two valves of different size with striation and central larger interspace. *Pseudo-nitzschia cuspidata*: two valves with fibulae and central larger interspace. *Pseudo-nitzschia lineola*: (a) chain in girdle view; (b) valve with striation and central larger interspace. Scale bars = 10  $\mu$ m.

*Pseudo-nitzschia*



*P. delicatissima*

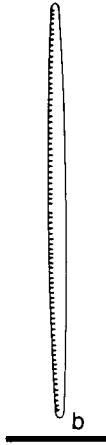

b

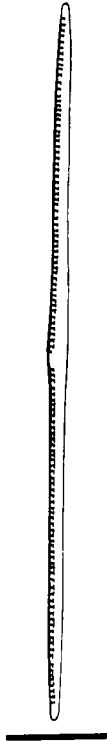

*P. inflatula*



*P. pseudodelicatissima*

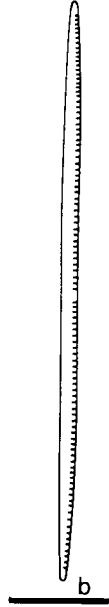

b

PLATE 72 *Pseudo-nitzschia delicatissima*: (a) chains in valve and girdle views, truncated cell ends in girdle view; (b) valve with fibulae and central larger interspace. *Pseudo-nitzschia inflatula*: valve with fibulae and central larger interspace. *Pseudo-nitzschia pseudodelicatissima*: (a) chains in girdle and valve views; (b) valve view with fibulae and central larger interspace. Scale bars = 10  $\mu$ m.

complex. Fibulae readily seen with LM; interstriae occasionally discernible with LM.

**Remarks:** *Pseudo-nitzschia cuspidata* is recognized by its comparatively wide, mainly lanceolate valves tapering along most of its length.

*Pseudo-nitzschia pseudodelicatissima* (Hasle) Hasle (Plate 72, Table 75)

**Basionym:** *Nitzschia pseudodelicatissima* Hasle.

**Synonym:** *Nitzschia delicatula* Hasle non *Nitzschia delicatula* Skvortzow (*vide* Hasle & Mendiola, 1967, p. 115).

**References:** Hasle, 1965b, p. 37, Plate 17, Figs. 1–16; Hasle, 1976b, p. 103; Takano & Kuroki, 1977, p. 44, Figs. 21–25; Hasle & Medlin, 1990c, p. 169, Plate 22.4, Figs. 1–16, Plate 22.6, Fig. 1; Hasle, 1993, p. 319; Hasle et al., 1995, Figs. 26–29 and 76–81.

**Girdle view:** Linear with pointed ends.

**Valve view:** Linear to almost linear, tapering for a longer or shorter distance toward narrow, rounded apices. Fibulae readily seen with LM; interstriae occasionally discernible with LM.

**Remarks:** *Pseudo-nitzschia pseudodelicatissima* is distinguished from *P. lineola* by a more delicate valve structure and from the rest of the *Nitzschia delicatissima* complex by the narrow linear valves. *Pseudo-nitzschia inflatula* (Hasle) Hasle (basionym: *Nitzschia inflatula*) is morphologically closely related to *P. pseudodelicatissima* but differs by being distinctly inflated in a short middle part and more or less distinctly inflated a short distance from the pointed apices (Plate 72; Hasle & Medlin, 1990c, Plate 22.5, Figs. 1–8).

2b. Square poroids; no central larger interspace.

*Pseudo-nitzschia granii* (Hasle) Hasle var. *granii* (Plate 73, Table 75)

**Basionym:** *Nitzschia granii* Hasle.

**References:** Hasle, 1964, p. 31, Plate 13, Fig. 10, Plate 14, Figs. 1–4; Hasle, 1974, p. 426; Hasle, 1993, p. 318.

**Girdle view:** Approximately linear.

**Valve view:** Spindle shaped, more or less gradually tapering into prolonged projections; apices rounded. Fibulae of irregular distances. Interstriae not resolved with LM.

*Pseudo-nitzschia granii* var. *curvata* Hasle.

**Basionym:** *Nitzschia granii* var. *curvata* Hasle.

**References:** Hasle, 1964, p. 32, Plate 13, Figs. 11 and 12, Plate 14, Figs. 5–7; Hasle, 1974, p. 426.

Var. *curvata* differs from the nominate variety by having curved cells (probably in girdle view) and broader, somewhat rhomboid valves.

**Remarks:** *Pseudo-nitzschia granii* occurs as single cells associated with colonies of the prymnesiophyte *Phaeocystis* and in the plankton.

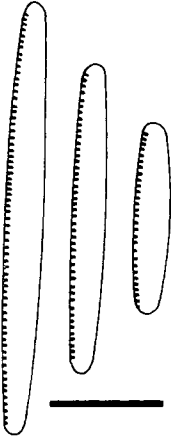

*Nitzschia americana*

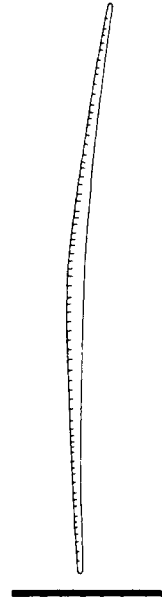

*Pseudo-nitzschia subcurvata*

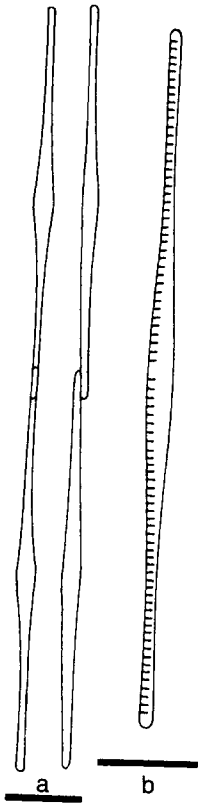

*P. prolongatoides*

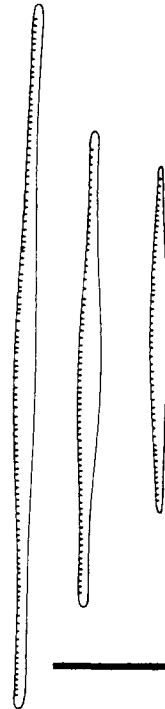

*P. granii* var. *granii*

*Pseudo-nitzschia subcurvata* (Hasle) G. Fryxell in Fryxell et al. (Plate 73, Table 75)

**Basionym:** *Nitzschia subcurvata* Hasle.

**References:** Hasle, 1964, p. 28, Plate 12, Figs. 14–16, Plate 13, Figs. 1 and 3; Hasle, 1974, p. 426; Hasle & Medlin, 1990a, p. 177, Plate 23.2, Figs. 6–8, Fryxell et al., 1991.

**Girdle view:** Overlap of cell ends very short.

**Valve view:** Middle part (one-fourth to one-half of cell length) dilated, abruptly attenuated toward long, slender projections; one side of valve straight or slightly concave and the other convex, especially in middle part of the valve. Fibulae of irregular distances, interstriae not resolved with LM.

**Remarks:** The species was transferred to the section *Pseudo-nitzschia* by Fryxell et al. (1991) based on type of colony formation, valve shape, and the nature of the raphe and fibulae.

**Distribution:**

*P. granii*—northern cold water region to temperate?

*P. cuspidata*—warm water region to temperate.

*P. prolongatoides*, *P. subcurvata*, and *P. turgiduloides*—southern cold water region.

*P. turgidula*, *P. lineola*, and *P. inflatula*—cosmopolitan.

The information on distribution is mainly from Hasle (1964, 1965b) and represents only fragmentary observations. *Pseudo-nitzschia delicatissima* and *P. pseudodelicatissima* are common, occasionally as the predominant diatom species, in North Atlantic plankton, and may be cosmopolitan although without reliable identifications from the Antarctic. *Pseudo-nitzschia granii* was described from the Norwegian Sea and has most probably a wide distribution in the North Atlantic region. Small needle-shaped *Nitzschia* species in or on *Phaeocystis* colonies have been reported from the Norwegian Sea and the North Sea since the beginning of this century (see Hasle, 1964, p. 30). In July, 1988 it was found together with *Phaeocystis* as far north as the King's Bay, Spitzbergen, ca. 80°N (G. Hasle and B. Heimdal, personal observations).

**How to identify:** In general, single valves mounted in a medium of a high refractive index examined with an oil immersion lens under darkfield or phase contrast illumination are required to identify the *Nitzschia*

---

PLATE 73 *Nitzschia americana*: valves showing size variation and fibulae. *Pseudo-nitzschia subcurvata*: valve with fibulae. *Pseudo-nitzschia prolongatoides*: (a) partial chains in valve and girdle views; (b) valve with fibulae and central larger interspace. *Pseudo-nitzschia granii*: var. *granii*: Valves, size variation, fibulae. Scale bars = 10µm.



*delicatissima* complex to species. In these circumstances the fibulae are resolved, and in some species the interstriae are also resolved. The structure of the striae is discernible in coarsely silicified specimens of a few species.

**Remarks:** Takano (1993) described *Nitzschia multistriata* from inlets of southern Japan, forming a bloom in summer 1991. It forms stepped chains, has no central nodule, more interstriae than fibulae, valve striae with two rows of circular poroids, and is thus similar to *P. delicatissima* except for the lack of a central nodule. Takano (1993, p. 40) placed the species “in the group pseudonitzschia,” and the correct name is therefore *Pseudo-nitzschia multistriata* (Takano) Takano with the group raised in rank to genus.

#### *Incertae sedis (Nitzschia)*

With the exception of *Nitzschia longissima*, records of the following species are in recent literature. Their morphology is poorly known and, as a consequence, so is their taxonomy. Our EM observations are fragmentary but are used here as a starting point for further investigations. As far as we have observed these species all have an eccentric raphe; they are marine and occur in plankton although that may not be their primary habitat.

A. Valve outline linear to lanceolate to slightly rostrate.

#### *Nitzschia americana* Hasle (Plate 73)

**References:** Hasle, 1964, p. 41, Plate 14, Figs. 13–19; Hasle, 1993, p. 318.

**Girdle view:** Linear.

**Valve view:** Linear with slightly convex margins; valve ends obtusely rounded. Fibulae more conspicuous than interstriae. Striae with two rows of small poroids (EM).

**Remarks:** *Nitzschia americana* is probably primarily epiphytic on *Chaetoceros setae* (G. Hasle and E. Syvertsen, personal observations) and possibly epiphytic on other diatoms. Being confused with a morphologically similar, probably undescribed species occurring in stepped colonies, *N. americana* was incorrectly transferred to *Pseudo-nitzschia* (Hasle, 1993).

**Morphometric data:** Apical axis, 16–40  $\mu\text{m}$ ; transapical axis, ca. 3  $\mu\text{m}$ ; 18–20 fibula and 27–30 striae in 10  $\mu\text{m}$ .

**Distribution:** Cosmopolitan (?).

---

PLATE 74 *Nitzschia sicula*: valves, var. *bicuneata* to the left, var. *rostrata* to the right. *Nitzschia longissima*: (a) whole cell; (b) valve view. *Nitzschia bicapitata*: valve with striae and central larger interspace. *Nitzschia braarudii*: valve with striae and slightly central larger interspace. Scale bars = 10  $\mu\text{m}$ .

Nitzschia

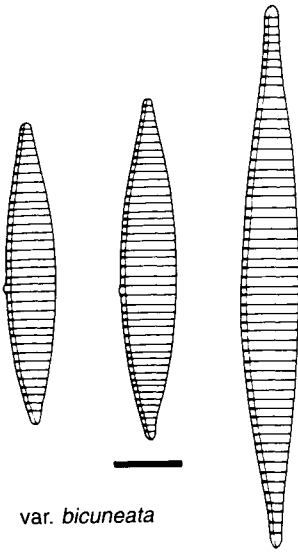

*var. bicuneata*

*var. rostrata*

*N. sricula*

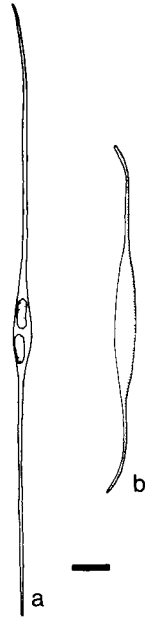

*N. longissima*

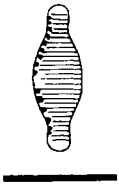

*N. bicapitata*

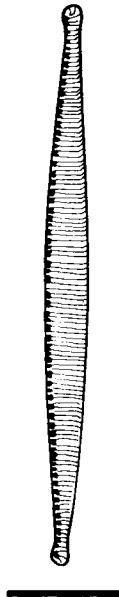

*N. braarudii*

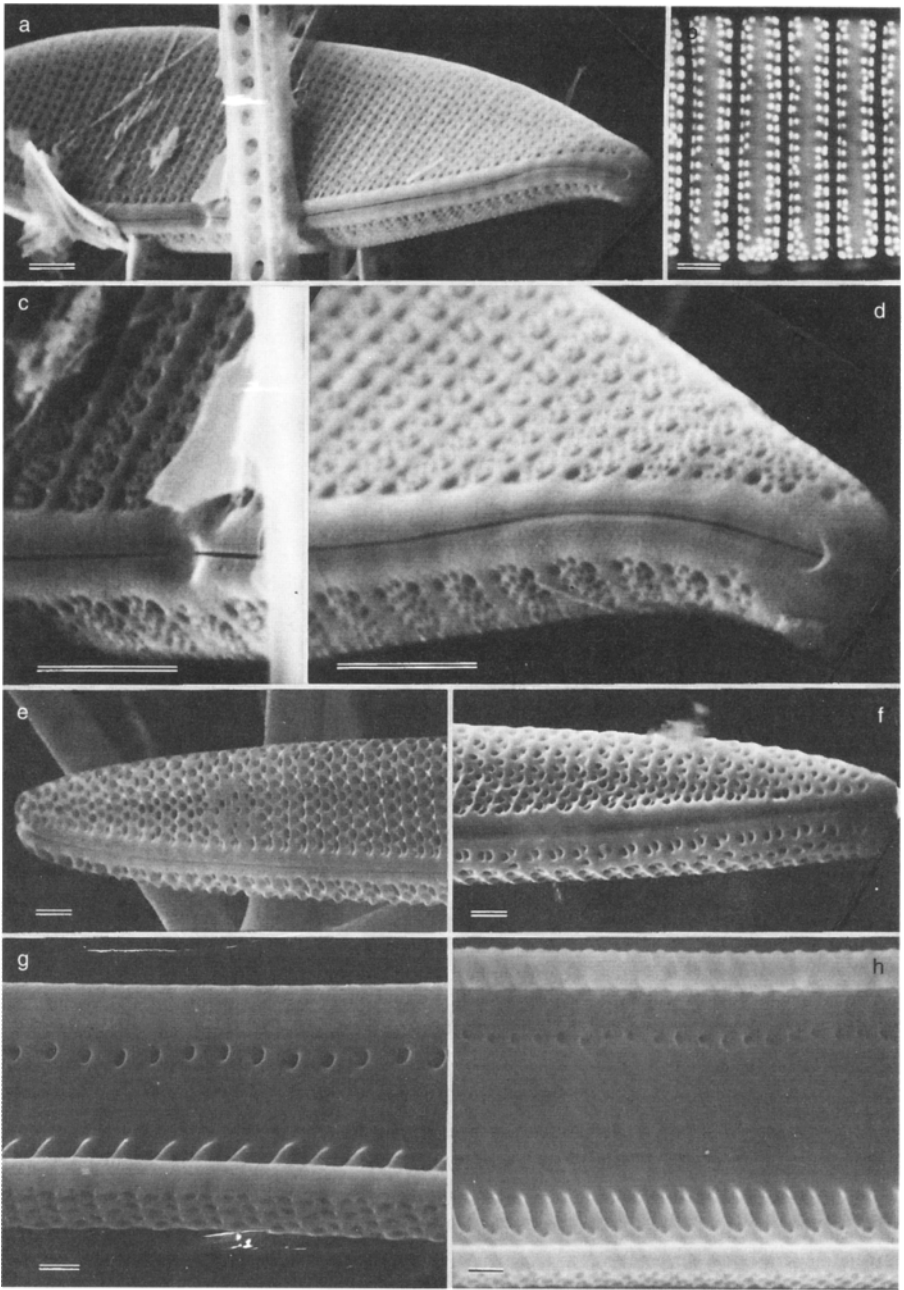

**PLATE 75** *Nitzschia sicula* (a–d): (a, c, and d) SEM of the same valve. (a) Showing stria structure on valve face and mantle and location of the raphe; (c) central depression with raphe endings; (d) valve apex with terminal raphe ending; (b) TEM of striae. *Nitzschia marina* (e–h) SEM; (e and f) external views of raphe and striae; (g and h) internal views of fibulae (lower part), valve surface, and perforations along the other margin. Scale bars = 1  $\mu$ m.

TABLE 76 Morphometric Data of *Nitzschia sicula* Varieties

Variety	Apical axis ( $\mu\text{m}$ )	Transapical axis ( $\mu\text{m}$ )	Striae and fibulae in 10 $\mu\text{m}$
<i>sicula</i>	23–121	5–8	7.5–11
<i>bicuneata</i>	32–39	6	8–12
<i>rostrata</i>	50–90	5–8	7–10
<i>migrans</i>	21–68	10–12	9–11

*Nitzschia sicula* (Castracane) Hustedt var. *sicula*, *N. sicula* var. *rostrata* Hustedt; *N. sicula* var. *bicuneata* Grunow in Cleve & Möller Hasle; *N. sicula* var. *migrans* (Cleve) Hasle (Plates 74 and 75, Table 76)

**Basionyms:** *Synedra sicula* Castracane; *Rhaphoneis?* (*Raphoneis*) *Diatoma?* *bicuneata* Grunow in Cleve & Möller; *Nitzschia migrans* Cleve.

**Synonyms:** *Pseudo-nitzschia sicula* (Castracane) H. Peragallo (in H. & M. Peragallo, 1897–1908); *Pseudo-nitzschia sicula* var. *bicuneata* (Grunow in Cleve & Möller) H. Peragallo in H. & M. Peragallo; *Pseudo-nitzschia sicula* var. *migrans* (Cleve) H. Peragallo in H. & M. Peragallo.

**References:** Castracane, 1875, p. 34, Plate 6, Fig. 7; Cleve & Möller, 1879, Nos. 208–210; Cleve, 1897b, p. 300, Fig. 9; H. & M. Peragallo, 1897–1908, p. 299, Plate 72, Figs. 25–27, Plate 82, Fig. 28; Heiden & Kolbe, 1928, p. 671; Hustedt, 1958a, p. 180, Figs. 128–132; Hasle, 1960, p. 26, Fig. 16; Hasle, 1964, p. 38, Figs. 11–13, Plate 5, Fig. 8, Plate 13, Figs. 14a and 14b, Plate 14, Fig. 22, Plate 16.

The varieties differ in valve outline, particularly in the shape of the apices. The eccentric canal raphe, the flattened, not undulated valves with a fairly coarse striation, and the equal numbers of fibulae and interstriae are common features. These diatoms have been recorded from widespread localities but evidently in small cell numbers which may be the reason why their fine structure, taxonomy and distribution are poorly known.

*Nitzschia sicula* var. *sicula*, var. *bicuneata*, and var. *rostrata* are lanceolate in valve outline with slightly rounded apices; the nominate variety has more obtuse ends, var. *bicuneata* has slightly protracted apices, and var. *rostrata* has rostrate valve ends. *Nitzschia sicula* var. *migrans* differs from the other varieties by being linear in the greater part of the valve length. Central raphe endings in a circular depression, a complex stria structure differing along the valve length, consisting of rows of small poroids close to the interstriae, and the absence of poroids in the external canal wall were documented with TEM and SEM (Plate 75, a–d; Hasle, 1964).

**Distribution:** Probably warm water region to temperate.

**How to identify:** These diatoms may be identified in water mounts in valve view but not in girdle view.

**Remarks:** Hustedt (1958a) made the combination *Nitzschia sicula* (Castracane) Hustedt. If, however, *Pseudo-nitzschia* was regarded as a separate genus, *P. sicula* was, in his opinion, the correct name. Mann (1978), on the other hand, found no problems in accommodating *N. sicula* in *Fragilariopsis*. In light of the present information on the stria structures of *Pseudo-nitzschia* and *Fragilariopsis*, in addition to no observations of a possible chain formation in *N. sicula*, we prefer to retain the species with its varieties in *Nitzschia*. We have no educated opinion, however, as to which section it belongs.

*Nitzschia marina* Grunow in Cleve & Grunow (Plate 75)

**Basionym:** *Nitzschia angustata* var. *marina* Grunow in Cleve & Möller, (*N. angusta* var. *marina* Cleve & Grunow, 1880, p. 70).

**Synonyms:** *Synedra gaussi* Heiden in Heiden & Kolbe; *Pseudo-nitzschia hustedtii* Meister.

**References:** Cleve & Möller, 1878, Nos. 154 and 155; Cleve & Grunow, 1880, p. 70; Van Heurck, 1880–1885, Plate 57, Figs. 26 and 27; H. & M. Peragallo, 1897–1908, p. 272, Plate 72, Fig. 24; Heiden & Kolbe, 1928, p. 561, Plate 5, Fig. 112; Meister, 1937, p. 272, Plate 11, Fig. 2; Kolbe, 1954, p. 40, Plate 3, Figs. 38–40; Kolbe, 1957, p. 39, Plate 1, Fig. 7; Simonsen, 1992, p. 22, Plate 18, Figs. 1–7.

**Valve view:** Linear to lanceolate with rounded apices. Valve wall extremely coarsely silicified. Valve mantle high and rounded. Valve face and mantle similar in structure: externally with biseriate striae and slightly raised interstriae. Striation just discernible with LM. Raphe not raised above valve surface; external canal wall unperforated except for the raphe slit. Fibulae strong and curved as seen on valves in internal views. Valve wall apparently double layered, the internal layer unperforated except for one row of holes along the non-raphe bearing margin.

**Morphometric data:** Apical axis, 53–353  $\mu\text{m}$ ; transapical axis, 8–12  $\mu\text{m}$ , fibulae and striae, 10–12 in 10  $\mu\text{m}$ .

**Distribution:** Warm water region.

*Nitzschia kolaczekii* Grunow

**References:** Grunow, 1867, p. 18; Grunow, 1877, p. 173, Plate 94, Fig. 10; Hustedt in A. Schmidt, 1924, Plate 349, Figs. 38 and 39; Kolbe, 1955, p. 174, Plate 2, Figs. 22 and 23; Hasle, 1960, p. 24, Plate 5, Figs. 50a–50c.

**Valve view:** lanceolate with slightly outstretched apices. The two raphes of a frustule diagonally located. Central interspace slightly larger than the rest. Valve with three stria systems, one transverse and two oblique ones as in *Pleurosigma*.

**Morphometric data:** Apical axis, 67–120  $\mu\text{m}$ ; transapical axis, 7.5–11  $\mu\text{m}$ ; eight or nine fibulae in 10  $\mu\text{m}$ ; 13–16 oblique, and 17–18 transverse striae in 10  $\mu\text{m}$ .

**Distribution:** Warm water region.

**How to identify:** *Nitzschia marina* and *N. kolaczekii* may be identified in water mounts in valve view but most likely not in girdle view.

**Remarks:** Cleve & Grunow (1880) placed *N. marina* in *Tryblionella* and *N. kolaczekii* in *Lanceolatae*. *Nitzschia sicula* and *N. marina* have similar valve and raphe structures as seen with LM. There is also a certain similarity between the two species in external valve structure as revealed with SEM. Information on the internal valve structure of *N. sicula* is lacking, however. The only available information on the valve structure of *N. kolaczekii* is from LM investigations. Based on light micrographs (Hasle, 1960, Plate 5, Fig. 50c) it may be assumed that the central circular depression with raphe endings is also present in *N. kolaczekii*.

#### B. Valves with prolonged projections.

*Nitzschia longissima* (Brébisson, in Kützing) Ralfs in Pritchard (Plate 74)

**Basionym:** *Ceratoneis longissima* Brébisson in Kützingm.

**References:** Kützing, 1849, p. 891; Pritchard, 1861, p. 783, Plate 4, Fig. 23; Cupp, 1943, p. 200, Fig. 154; Hendey, 1964, p. 283; Hasle, 1964, p. 20, Plate 10, Figs. 5–7; Hasle & Medlin, 1990a, p. 177, Plate 23.1, Figs. 5–7.

**Valve view:** Linear to lanceolate, tapering to very long projections. Raphe with fibulae and central larger interspace distinct in mounted cleaned material. External canal wall poroid (TEM). Transverse striae and interstriae hardly visible with LM.

**Morphometric data:** Apical axis, 125–450  $\mu\text{m}$ ; transapical axis, 6–7  $\mu\text{m}$ ; fibulae 6–14? in 10  $\mu\text{m}$ ; striae, ca. 16 in 10  $\mu\text{m}$  (Cupp, 1943), 52–60 in 10  $\mu\text{m}$  (Hasle, 1964).

**Distribution:** Cosmopolitan (?), inshore waters.

**How to identify:** As mentioned previously *C. closterium* and *N. longissima* may easily be confused when examined as entire cells in water mounts. Acid-cleaned material mounted in a medium of a high refractive index, or often EM observations, may be needed to distinguish between the extremely weakly silicified *C. closterium* with the numerous narrow bands and the simple canal raphe and the more coarsely silicified *N. longissima* with fibulae connected with silicified strips running parallel to the raphe slit (Hasle, 1964, Plate 10).

**Remarks:** Detailed morphological studies are needed before a good definition of this and similar freshwater and brackish water species can be given. Cleve & Grunow (1880, p. 100) placed *N. longissima* in *Nitzschiella*,

which they characterized as a group with "Schalen mit excentrischem Kiele und lang vorgezogenen Spitzen."

C. Valves with capitate ends.

*Nitzschia bicapitata* Cleve (Plate 74, Table 77)

References: Cleve, 1901b, p. 933, Fig. 12; Hustedt, 1958a, p. 169, Figs. 176–190; Hasle, 1960, p. 21, Fig. 10; Hasle, 1964, p. 37, Plate 5, Fig. 7, Plate 14, Figs. 8–12, Plate 15, Figs. 3–6; Simonsen, 1974, p. 50, Plate 35, Figs. 3–15; Kaczmarska & Fryxell, 1986, p. 242, Fig. 4; Kaczmarska et al., 1986, p. 1859, Fig. 10.

**Valve view:** Valves lanceolate with capitate ends less pronounced in smaller specimens. Fibulae and central larger interspace readily observed on cleaned mounted valves; striae with one row of areolae discernible on well silicified specimens. Central nodule and external canal wall without poroids observed with EM.

**Remarks:** Kaczmarska & Fryxell (1986, p. 237) carried out a detailed morphological study of "the diatom known in the literature as *Nitzschia bicapitata* Cl." SEM investigations showed three morphotypes of *N. bicapitata* Cleve *sensu lato* and a new species, *N. bifurcata* Kaczmarska & Licea. The epithet of the new species refers to the stria structure revealed with SEM. Whereas the rest of the *N. bifurcata* valve has striae with one row of areolae, like in *N. bicapitata*, the margin opposite to the raphe has two rows of alternating small pores.

*Nitzschia braarudii* Hasle (Plate 74, Table 77)

**Synonym:** *Nitzschia capitata* Heiden in Heiden & Kolbe.

References: Heiden & Kolbe, 1928, p. 666, Plate 7, Fig. 151; Hasle, 1960, p. 22, Fig. 11, Plate 7, Figs. 58–63; Hasle, 1964, p. 35, Plate 2, Fig. 1, Plate 14, Fig. 20, Plate 15, Figs. 1 and 2; Taylor, 1967, p. 450, Fig. 30;

TABLE 77 Morphometric Data of *Nitzschia* spp.

Species/author	Apical axis (μm)	Transapical axis (μm)	Striae in 10 μm	Fibulae in 10 μm
<i>N. bicapitata</i>				
Cleve, 1901b	12–16	3–5	26	13
Hustedt, 1958a	6–30	3–3.5	26–28	12–14
Hasle, 1964	6–30	2.5–5.5	18–28	12–16
<i>N. bifurcata</i> <sup>a</sup>	7–31	3–6	22–28	10–16
<i>N. braarudii</i>	35–63	3–5	22–30	10–15

<sup>a</sup> Mentioned in the text for comparison; morphometric data from Kaczmarska & Fryxell (1986).

Simonsen, 1974, p. 50, Plate 35, Fig. 2; Kaczmarska et al., 1986, p. 1860, Fig. 15; Simonsen, 1992, p. 83, Plate 83, Figs. 5–7.

**Valve view:** Central part with straight or slightly rounded margins varying in length with length of valve. Valve narrowing toward capitate ends. Fibulae, a slightly larger central interspace, and interstriae resolved with LM of acid cleaned mounted valves. Stria structure consisting of one row of areolae, a central nodule, and external canal wall without poroids were observed with EM.

**Remarks:** *Nitzschia braarudii* and *N. bicapitata* belong to a large group of species characterized by capitate ends and mainly found in tropical and subtropical open ocean plankton (Hasle, 1960; Simonsen, 1974; Kaczmarska & Fryxell, 1986, 1994; Kaczmarska et al., 1986). Simonsen (1992) examined the type material of *N. capitata* and isotype material of *N. braarudii* and concluded that they were conspecific. He also found that the name *N. capitata* was preoccupied and that therefore the name *N. braarudii* could be used. Hasle (1960) gave a Latin diagnosis and illustrations of *N. braarudii* and Equatorial and subantarctic Pacific Ocean as type locality. The description is validated in the Taxonomic Appendix (this chapter) giving the holotype, isotypes and the type locality.

**How to identify:** Kaczmarska & Fryxell's (1986) investigation demonstrates the problems involved in identifying marine, planktonic *Nitzschia* species of this group, and also when the fibulae and interstriae of cleaned mounted specimens are visible with LM.

**Distribution:** Warm water region to temperate. *Nitzschia bicapitata* has been found between 66°N and 62°S (Hasle, 1976a). *Nitzschia braarudii* seems to have a more restricted longitudinal distribution.

## METHODOLOGY

---

Detailed procedures for collection, preservation, and examination of phytoplankton have been described in the UNESCO Phytoplankton manual (Sournia, 1978). Because of the wide range of habitats, cell sizes, degree of silicification, and fineness, a variety of methods are required for collection, preparation, and microscopy of diatoms. The current diatom literature contains a multitude of methods, particularly for cleaning and mounting (e.g., Ricard, 1987; Round et al., 1990). The selection mentioned below is intended as a guide and represents simple, general methods to obtain material adequate for identification at the species level.

### COLLECTION AND CONCENTRATION (Table 78)

Sampling by water bottle is the recommended method (Sournia, 1978, p. 33) to obtain a correct picture of the quantitative composition of the phyto-



TABLE 78 Collection

Method	Use	Disadvantage
Water bottle	Enumeration of cells; all species	Few rare species
Pump	Quantitative and qualitative; large amount of material for enumeration and identification	Sometimes biased species composition; damage to some species
Membrane filtering	In combination with one of the methods above; samples for direct cell enumeration and microscopy (LM, SEM)	May be selective; damage to some specimens
Net	Large quantities of material for identification	Selective, depending on mesh size, net proportions and composition of the plankton

plankton. Theoretically, a water bottle sample contains all but the rarest organisms in the water mass sampled and includes the whole size spectrum from the largest entities, like diatom colonies, to the smallest single cells. Similar results can be obtained by pump sampling (Sournia, 1978, p. 41), which samples much larger quantities of water allowing the collection of the rarer species. The technique has its disadvantages, however, e.g., breaking up colonies, breaking off large *Chaetoceros* setae, and breaking into pieces long pennate cells like *Thalassiothrix* spp. In contrast to these quantitative methods, sampling by plankton nets (Sournia, 1978, p. 50) is highly selective, depending on the mesh size of the gauze, net towing speed, and the species present in the water. *Chaetoceros* setae, for instance, may form a fine network inside the gauze, and very small single cells, which in other cases pass through the meshes, are retained. On the other hand, nets with very fine meshes (e.g., 5 or 10  $\mu\text{m}$ ) often filter too little water to provide an adequate diatom sample. As a compromise, the most useful mesh size for collecting diatoms is 25  $\mu\text{m}$ .

Net hauls have the advantage of a simultaneous collection and concentration of the plankton providing sufficient quantities for species identification. Water bottle and pump samples in most cases have to be concentrated. The smaller the subsample, the fewer number of rare species will be obtained. On the other hand, there is no point in concentrating large quantities of a sample rich in one or a few species. Concentration by settling (Sournia, 1978, p. 88), centrifugation (Sournia, 1978, p. 98), and filtration (Sournia, 1978, p. 108) are the most used methods.

The rich plankton in the marginal ice zone and the ice-covered waters of the polar seas has attracted particular attention during the past decades. Scuba

diving has shown that at least parts of the plankton flora begin their spring development on the undersurface of the ice. In addition, there is a particular rich and highly specialized subice flora in polar waters which may become part of the plankton when the ice melts (Syvertsen, 1991). An electric suction pump or "vacuum cleaner" used in the study of ice zoo benthos (Lønne, 1988) has been modified to sample the subice flora and algae found in cracks and crevices. A plankton net is placed in front of or behind the impeller, and the water is pushed at low speed through the net. The action is gentle and the algal cells are not damaged.

### UNIALGAL CULTURES AS A MEANS FOR SPECIES IDENTIFICATION

Natural samples often yield cells at approximately the same stage in the life cycle of the species in question. This is presumably due to a coordination of processes, such as sexual reproduction (auxospore formation in diatoms), caused by chemical and physical factors in the environment. For similar reasons, diatom resting spores are often formed only at certain times. For studies of morphology and taxonomy, it is desirable to know the whole range of morphological variation including the effect of size variation and resting spore formation. This information is normally not obtained by studying a few natural samples. Cultures in which auxospore and resting spore formation can be induced may increase the information, although a single clone does not necessarily reflect the whole range of variation of a species. It is important to note, however, that a single clonal culture does not necessarily reflect the whole possible range in variation of a population or species.

Dilution cultures (Sournia, 1978, p. 218) or crude cultures may serve as a base for unialgal cultures. The best universal method to establish unialgal diatom cultures is to isolate single cells by a micropipette (Stein, 1973, p. 53) into an appropriate synthetic or enriched seawater growth medium (Stein, 1973, p. 25).

It is important to keep in mind that dense unialgal cultures as well as dense natural populations may contain aberrant forms. This seems to be especially the case for *Pseudo-nitzschia* spp. and *Synedropsis hyperborea* and related species (Grunow, 1884; Takano & Kikuchi, 1985; Subba Rao & Wohlgeschaffen, 1990; Hasle et al., 1994).

### PRESERVATION AND STORAGE (Table 79)

If possible, diatom samples should be studied immediately after sampling for information on colony formation and chloroplasts. However, in most cases, due to practical reasons they have to be preserved for later studies. A pH lower than 7 is preferable to hinder dissolution of the siliceous structures. The most

TABLE 79 Preservation

Agent	Solution	Comments
Formaldehyde/acetic acid	Equal volumes of p.a. grade 40% HCHO and 100% acetic acid	20 ml of the solution to 70 ml net sample; 2 ml of the solution to 100 ml water sample (= 0.4% HCHO)
Formaldehyde, alkaline	Equal volumes of 40% HCHO and distilled water; to 1 liter solution 100 g hexamin	As described above
Lugol's solution, acidic	Dissolve in 1 liter distilled water 100 g KI, then 50 g I <sub>2</sub> , and finally add 100 ml glacial acetic acid	For water samples, 0.2–0.4 ml to 100 ml sample; for net samples, add to a weakly brown color

*Note.* Samples should be preserved immediately after collection and stored in glass bottles, preferably in darkness and at low temperature. Iodine will oxidize with time, and samples preserved with Lugol's solution need regular attention. Diatom frustules stored in alkaline solution may dissolve with time.

commonly used preservatives are formaldehyde neutralized with hexamethylenetetramine (hexamin) or acidified with acetic acid, and the Lugol's solution (Sournia, 1978, p. 69).

For storage of diatom samples over a longer period of time containers (bottles, jars) of moderate glass quality should be used. Silica dissolved from the containers apparently helps to keep the diatom siliceous wall intact. Metal caps and lids should be avoided. The samples should not be exposed to temperatures much higher than ca. 15°C and should be kept away from bright light, especially when preserved with Lugol's or other iodine solutions.

#### PREPARATION FOR LIGHT MICROSCOPY (Tables 80 and 81)

Examination of raw (not cleaned) material in a water mount or embedded in a resin may give sufficient information to identify a number of common planktonic diatoms, e.g., *Chaetoceros* spp. and *Rhizosolenia* spp. (Sournia, 1978, p. 137). These diatoms are identified by their gross morphology and/or special structures like the *Chaetoceros* setae and the shape of the *Rhizosolenia* valves and processes. This procedure is often ineffective for revealing the essential morphological structures of other genera, e.g., the areolation and processes of *Coscinodiscus* and *Thalassiosira* and the striation and raphe structure of *Navicula* and *Pseudo-nitzschia*. Cell content and the organic part of the cell wall obscure the image of the valve structures and have to be removed. The

TABLE 80 Cleaning of Diatom Material

Method	Procedure	Comments
von Stosch's method	Concentrate sample to near dryness, add equal amount of HNO <sub>3</sub> and 3× sample amount of H <sub>2</sub> SO <sub>4</sub> , boil for ca. 3 min, cool, and rinse with distilled water until free of acid	Fast method, usually with good result
Simonsen's method	Rinse sample with distilled water, add an equal amount of KMnO <sub>3</sub> , agitate, leave for 24 hr, add an equal amount of HCl, heat until the sample becomes clear or only slightly colored, and rinse until free of acid	More time consuming, reliable
UV, H <sub>2</sub> O <sub>2</sub> enzymes	Useful to obtain intact frustules	Difficult and time consuming

*Note.* Rinse and concentrate samples by settling or centrifugation at approximately 4000 rpm: small and lightly silicified valves and bands need long settling/centrifugation time; for settling, usually overnight; for centrifugation, up to half an hour.

structures are best seen on single valves. This is a further reason to remove the organic material which keeps the various frustular elements together.

By acid cleaning (Table 80) the diatom frustule separates into single valves and bands free from organic material. Ultraviolet and enzyme techniques (Table 80) usually give intact frustules cleaned of organic material. The refractive index of silica and water is about the same, and to increase the contrast the cleaned material is embedded in a resin of a higher refractive index than that of silica (Table 81). The normal procedure thus includes (1) removal of the preservative by repeated centrifugation and decanting with distilled water, (2) cleaning, followed by (3) embedding in a mounting medium.

### PREPARATION FOR ELECTRON MICROSCOPY

The method of preparation for EM depends on whether the objective of the investigation is to study the cell interior (cell organelles, etc.) or the morphology of the siliceous cell wall components. Only the latter is relevant to this chapter.

For a few species (usually the more heavily silicified ones) intact frustules may be obtained by simply air drying a drop of raw material after thorough rinsing with distilled water. Although delicate specimens will be crushed by

TABLE 81 Embedding for Light Microscopy

Media	Refractive index	Solvent	Manufacturer
Clearax	1.67	Xylene, acetone	G. T. Gurr
Naphrax	1.72	Xylene, toluene, acetone	Northern Biological Supplies
Pleurax	1.74	Alcohol	(See von Stosch, 1974)

*Note.* A drop of the cleaned sample in distilled water is left to dry on a coverslip ( $0.17 \pm 0.02$  mm thick) cleaned with alcohol. The medium is applied to the dry sample and left to dry. The cover slip is "picked up" by pressing a cleaned microscope slide gently toward it. Thereafter, the slide with the cover slip is heated to ca. 50–70°C for a few minutes to remove air bubbles and harden the medium. Rinsed but not cleaned material to be embedded in Pleurax has to first be brought into 100% alcohol. The sample is then concentrated to near dryness, mixed with Pleurax, and put onto a coverslip. The coverslip is placed face down on a microscope slide and left to dry at room temperature or gently heated on a hot plate till the solvent has evaporated. Addresses of manufacturers cited: G. T. Gurr Ltd/Baird and Tatlock Ltd, Freshwater Road, Chadwell Heath, Romford, Essex RM1 1HA, UK; Northern Biological Supplies, 31 Cheltenham Avenue, Ipswich, Suffolk IP1 4LN, UK.

this treatment, useful information, especially on the girdle, can be obtained. Freeze-drying (Williams, 1953) is an alternative, but the most reliable results are obtained with critical point drying (Cohen, 1974). The equipment and methods are developed for general use and not especially for diatoms. For diatoms particular vessels to contain the sample during the drying have to be constructed. The end product is usually a dry powder that subsequently may be further prepared for SEM or TEM.

On a routine basis acid-cleaned material prepared for LM is used for both TEM and SEM. For TEM, a drop of an aqueous suspension of cleaned material is put onto a formvar-coated copper grid (Sournia, 1978, p. 138). After air drying, it can be studied with TEM without further treatment. The same procedure can be followed for SEM, except that the sample suspension is put onto a small glass coverslip or other smooth material. After air drying, the material has to be coated with a metal (usually Au/Pd, Pt) film in an evaporating or sputter device.

## MICROSCOPY

### LM

Identification of diatoms in water samples is usually best done by using phase contrast optics, which reveal especially well lightly silicified structures, like delicate *Chaetoceros* setae, and also the organic chitan threads in Thalassiosiraceae. Brightfield or differential interference contrast (DIC) may be preferable for the study of cell organelles. Ten or 25× objectives should be sufficient to

recognize common species. If the goal is to pick out single cells, an objective with a long working distance is preferable. Normally, a compound microscope with a 10 $\times$  objective is the best choice, allowing enough space for the use of a micropipette and sufficient magnification to control the isolation of the single cell. A dissecting (binocular) microscope will provide even more space for operating the pipette.

The study of the finer structures of the silica wall requires cleaned, embedded material and a 40 $\times$  dry or, preferably, a 100 $\times$  oil immersion objective. Phase contrast and/or DIC are recommended for the examination of lightly silicified diatoms to increase the contrast. For extremely lightly silicified diatoms this is best done with a so-called negative phase contrast objective. For the examination of heavily silicified diatoms there is no need to increase the contrast and brightfield is a better choice. For a superficial scanning of a water or permanent mount a darkfield illumination, obtained by a 10 $\times$  objective and the phase contrast condenser in a position corresponding to a 100 $\times$  objective, is useful for showing the siliceous elements distinctly against a black background.

### TEM

This type of electron microscopy of cleaned diatom material allows the highest resolution and thus reveals most details. The contrast between heavily silicified parts of the valves and less silicified structures calls for caution during the printing of TEM pictures, however. Finer details like vela, are easily lost at the cost of coarser details that need a different printing. It also must be kept in mind that three dimensional structures are “flattened” into a two-dimensional picture, and the two surfaces of the diatom wall are seen as one image, except when stereo pictures are used. This makes interpretation of the image demanding and considerable experience is often needed to arrive at the right conclusions.

### SEM

This type of electron microscopy gives an apparent three-dimensional image with only one of the surfaces revealed. This provides the possibility to differentiate between the various valve processes, provided the internal surface of cleaned single valves are examined. SEM also shows the respective positions of areola vela and foramina. On the other hand, the construction of the cell wall cannot be studied unless broken parts are available. The resolution is often poor. However, the use of high-resolution low-voltage SEM may be an improvement since this instrument allows high resolution without beam damage to the specimens (Navarro, 1993).

### WHAT TO LOOK FOR—GENERAL HINTS FOR IDENTIFICATION AND PREPARATION

To identify intact (whole) diatoms we first of all need to know which side the cell is viewed: valve, broad or narrow girdle view, or from an angle. Intact

single cells with a short perivalvar axis tend to lie valve side up under the coverslip (*Coscinodiscus radiatus* and *Pleurosigma*). Diatoms with a perivalvar axis longer than the cell diameter or the apical axis turn girdle side upwards (*Corethron*, and *Rhizosolenia*). Some colony types are normally seen in girdle view in a water mount (*Chaetoceros*, *Fragilariopsis*, and *Thalassiosira*); others may show either valve or girdle side (*Pseudo-nitzschia*, *Asterionellopsis*, and *Thalassionema*).

Cylindrical and discoid diatoms are readily recognized by the general circular outlines in valve view and rectangular outlines in girdle view. The distinction between the two views of the more or less spindle-shaped cells (e.g. *Pseudo-nitzschia*, *Thalassionema*, and *Thalassiothrix*) is more problematic. The shape of cell ends will usually help, being straight cut off or pointed in girdle view and more obtuse in valve view.

Once the orientation of the cell is ascertained, the next step is to look for outstanding features like setae (*Chaetocerotaceae*), shape of linking processes (*Skeletonema*), and in unpreserved material, organic threads from the valve (*Thalassiosiraceae*) or gliding movements indicating the presence of a raphe.

Frustular elements cleaned of organic material may also be oriented in various ways in a permanent mount. Flattened valves with a low mantle will usually be seen in valve view (some *Coscinodiscus* spp., most *Navicula* spp.), while valves with a high mantle and/or protuberances may appear in girdle view (*Eucampia*, and *Rhizosolenia*). Lightly silicified bands shaped as those in *Rhizosolenia* and *Stephanopyxis* often lie with girdle side up. The more heavily silicified bands, especially those with a septum, tend to be seen as ellipses or circles (*Rhabdonema* and *Thalassiosira*).

Valves and bands are often seen in strewn permanent mounts in a view that does not provide the necessary information for identification. The single frustular element may be brought into the desirable position under the microscope by using a micropipette before drying. Alternatively, they may be turned by means of a needle when dried to the coverslip. The single element may also be turned after the resin is added if utilizing one that does not need to be heated (e.g., *Pleurax*).

## TAXONOMIC APPENDIX

---

### NEW GENUS

*Lioloma* Hasle gen. nov.

Cells long, narrow, twisted. Valve ends dissimilar, both ends with a labiate process, one end with apical spine(s). Marginal spines absent. Internal foramina and external vela about the same size. Sternum variable in width along the apical axis, no raphe.

Cellulae longae, angustae, tortae. Poli valvae dissimiles, uterque rimoportula una munitus, unum extremum cum spina (spinis). Nullae spinae marginales. Foramina interna et vela externa eiusdem prope magnitudinis. Sternum variae latitudinis axem apicalem sequens, sine raphe. **Typus:** *Lioloma elongatum* (Grunow) Hasle comb. nov.

## NEW NAMES

*Meuniera* P. C. Silva, nom. nov. pro *Stauropsis* Meunier, 1910 (*Microplankton Barents et Kara*, p. 318) non *Stauropsis* Reichenbach, 1860 (*Hamburger Garten- und Blumenzeitung* 16: 117. Orchidaceae).

**Type:** *M. membranacea* (Cleve) P. C. Silva comb. nov.

*Pleurosigma simonsenii* Hasle, nom. nov. pro *Pleurosigma planctonicum* Simonsen, 1974 ("Meteor" *Forschungsergebnisse, Reihe D.* 19:46, Plate 30); non *P. planctonicum* Cleve-Euler, 1952 (*Kungliga Svenska Vetenskapsakademiens Handlingar* ser. 4, 3(3):23, Fig. 1374).

## VALIDATION OF NAMES

### New Taxa

**Hemidiscaceae** Hendey, 1937 emend. Simonsen, 1975 ex Hasle  
Cells cylindrical to discoid, usually solitary. Valve outline circular, slightly elliptical, ovate or semi-circular. Valve face and mantle often different in structure. One marginal ring of large labiate processes (rimoportulae), similar in shape and generally also similar in size. A pseudonodus usually present. Cellulae discoiideae vel cylindricae, plerumque solitariae. Valvae circulares, parum ellipticae, ovatae vel semicirculares. Frons valvae e limbo saepe structura differens, anulum marginalem rimoportularum forma amplitudineque similarium habens. Pseudonodus plerumque adest.

*Nitzschia braarudii* Hasle

**Description:** Hasle, 1960 (*Skrifter utgitt av Det Norske Videnskaps-Akademi i Oslo I. Matematisk-Naturvidenskapelige Klasse* 2:22, Fig. 11, Plate 7, Figs. 58–63),

**Type locality:** 52°50'S, 90°03'W.

**Holotype:** IMBB slide No. 78 conserved in Section of Marine Botany, Department of Biology, University of Oslo.

**Isotypes:** IMBB slides Nos. 79, 80, BRM Zv 2/95, BM 78510.

*Thalassiothrix gibberula* Hasle

**Description:** Hasle, 1960 (*Skrifter utgitt av Det Norske Videnskaps-Akademi i Oslo I. Matematisk-Naturvidenskapelige Klasse* 2:19, Fig. 6, Plate 5, Figs. 46–48).

**Type locality:** 00°–02°N, 145°W.



**Holotype:** IMBB slide No. 102 conserved in Section of Marine Botany, Department of Biology, University of Oslo.

## NEW NOMENCLATURAL COMBINATIONS

*Dactyliosolen fragilissimus* (Bergon) Hasle comb. nov.

**Basionym:** *Rhizosolenia fragilissima* Bergon, 1903 (*Bulletin de la Société scientifique d'Arachon* 6: 49, Plate 1, Figs. 9 and 10).

*Dactyliosolen phuketensis* (Sundström) Hasle comb. nov.

**Basionym:** *Rhizosolenia phuketensis* Sundström, 1980 (*Botaniska Notiser* 133: 579, Figs. 1 and 3).

*Guinardia cylindrus* (Cleve) Hasle comb. nov.

**Basionym:** *Rhizosolenia cylindrus* Cleve, 1897 (*A Treatise on the Phytoplankton of the Atlantic and Its Tributaries*, p. 24, Plate 2, Fig. 12).

*Guinardia delicatula* (Cleve) Hasle comb. nov.

**Basionym:** *Rhizosolenia delicatula* Cleve, 1900 (*Kongliga Svenska Vetenskaps-Akademiens Handlingar* 32(8): 28, Fig. 11).

*Guinardia striata* (Stolterfoth) Hasle comb. nov.

**Basionym:** *Eucampia striata* Stolterfoth, 1879 (*Journal of Royal Microscopical Society* 2:835).

**Synonym:** *Rhizosolenia stolterfothii* H. Peragallo, 1888 (*Bulletin de la Société Histoire Naturelle Toulouse* 22: 82, Plate 6, Fig. 44).

*Lioloma elongatum* (Grunow) Hasle comb. nov.

**Basionym:** *Thalassiothrix elongata* Grunow in Van Heurck, 1881 (*Synopsis des Diatomées de Belgique*, Plate 37, Fig. 9).

*Lioloma delicatulum* (Cupp) Hasle comb. nov.

**Basionym:** *Thalassiothrix delicatula* Cupp, 1943 (*Bulletin of the Scripps Institution of Oceanography of the University of California* 5:188, Fig. 137).

*Lioloma pacificum* (Cupp) Hasle comb. nov.

**Basionym:** *Thalassiothrix mediterranea* var. *pacifica* Cupp, 1943 (*Bulletin of the Scripps Institution of Oceanography of the University of California* 5:185, Fig. 136).

*Meuniera membranacea* (Cleve) P. C. Silva comb. nov.

**Basionym:** *Navicula membranacea* Cleve, 1897 (*A treatise on the phytoplankton of the Atlantic and its tributaries*, p. 24, Plate 2, Figs. 25–28).

*Thalassionema javanicum* (Grunow) Hasle comb. nov.

**Basionym:** *Thalassiothrix frauenfeldii* var. *javanica* Grunow in Van Heurck, 1881 (*Synopsis des Diatomées de Belgique*, Plate 37, Fig. 13).

**Synonyms:** *Thalassiothrix* (*faufenfeldii* [sic!]) var. *javanica* (Grunow) Cleve, 1900 (*Göteborgs Kungliga Vetenskaps-och Vitterhets-Samhälles Handlingar Fjärde föliden* 3(3):357); *Thalassiothrix javanica* (Grunow) Hustedt ex Meister, 1932 (*Kieselalgen aus Asien*, p. 25).

*Thalassionema pseudonitzschoioides* (Schuette & Schrader) Hasle comb. nov.

**Basionym:** *Thalassiothrix pseudonitzschoioides* Schuette & Schrader, 1982 (*Bacillaria* 5:214, Figs. 1–30).

## COMMON DIATOM SYNONYMS

---

*Actinocyclus actinochilus* (Ehrenberg) Simonsen 1982

= *Charcotia actinochila* (Ehrenberg) Hustedt 1958a

*Actinocyclus curvatulus* Janisch (in A. Schmidt, 1878)

= *Coscinodiscus curvatulus* var. *subocellatus* Grunow 1884

= *Actinocyclus subocellatus* (Grunow) Rattray 1890b

*Actinocyclus kützingii* (A. Schmidt) Simonsen 1975

= *Coscinodiscus kützingii* A. Schmidt 1878

*Actinocyclus normanii* (Gregory) Hustedt 1957

= *Coscinodiscus normanii* Gregory (in Greville, 1859a)

*Actinocyclus normanii* f. *subsalsus* (Juhlin-Dannfelt) Hustedt 1957

= *Coscinodiscus subsalsus* Juhlin-Dannfelt 1882

*Actinocyclus octonarius* Ehrenberg 1838

= *Actinocyclus ehrenbergii* Ralfs (in Pritchard, 1861)

*Actinoptychus senarius* (Ehrenberg) Ehrenberg 1843

= *Actinocyclus senarius* Ehrenberg 1838

= *Actinoptychus undulatus* (Bailey) Ralfs (in Pritchard, 1861)

*Asterionellopsis glacialis* (Castracane) F. E. Round (in Round et al., 1990)

= *Asterionella glacialis* Castracane 1886

= *Asterionella japonica* Cleve (in Cleve & Möller, 1882)

*Asterionellopsis kariana* Grunow (in Cleve & Grunow) F. E. Round (in Round et al., 1990)

= *Asterionella kariana* Grunow (in Cleve & Grunow, 1880)

*Asterolampra marylandica* Ehrenberg 1844a

= *Asterolampra vanheurckii* Brun 1891

*Asteromphalus arachne* (Brébisson) Ralfs (in Pritchard, 1861)

= *Spatangidium arachne* Brébisson 1857

- Attheya septentrionalis* (Østrup) Crawford (in Crawford et al., 1994)  
 = *Chaetoceros septentrionalis* Østrup 1895  
 = *Gonioceros septentrionalis* (Østrup) Round, Crawford, & Mann 1990  
*Azpeitia africana* (Janisch ex A. Schmidt) G. Fryxell & T. P. Watkins (in Fryxell et al., 1986b)  
 = *Coscinodiscus africanus* Janisch ex A. Schmidt 1878  
*Azpeitia neocrenulata* (VanLandingham) G. Fryxell & T. P. Watkins (in Fryxell et al., 1986b)  
 = *Coscinodiscus crenulatus* Grunow 1884  
 = *Coscinodiscus neocrenulatus* VanLandingham 1968  
*Azpeitia nodulifera* (A. Schmidt) G. Fryxell & P. A. Sims (in Fryxell et al., 1986b)  
 = *Coscinodiscus nodulifer* A. Schmidt 1878  
*Azpeitia tabularis* (Grunow) G. Fryxell & P. A. Sims (in Fryxell et al., 1986b)  
 = *Coscinodiscus tabularis* Grunow 1884  
*Bacteriastrum furcatum* Shadbolt 1854  
 = *Bacteriastrum varians* Lauder 1864a  
*Bacterosira bathyomphala* (Cleve) Syvertsen & Hasle (in Hasle & Syvertsen, 1993)  
 = *Coscinodiscus bathyomphalus* Cleve 1883  
 = *Bacterosira fragilis* Gran 1900  
*Bacillaria paxillifera* (O. F. Müller) Hendeby 1964  
 = *Bacillaria paradoxa* Gmelin 1791  
 = *Nitzschia paradoxa* (Gmelin) Grunow in Cleve & Grunow 1880  
*Banquisia belgicae* (Van Heurck) Paddock 1988  
 = *Amphiprora belgicae* Van Heurck 1909  
 = *Tropidoneis belgicae* (Van Heurck) Heiden (in Heiden & Kolbe, 1928)  
*Bleakeleya notata* (Grunow) F. E. Round (in Round et al., 1990)  
 = *Asterionella bleakeleyi* var. *notata* Grunow 1867  
*Brockmanniella brockmannii* (Hustedt) Hasle, von Stosch, & Syvertsen 1983  
 = *Plagiogramma brockmannii* Hustedt 1939  
*Cerataulina pelagica* (Cleve) Hendeby 1937  
 = *Cerataulina bergonii* (H. Peragallo) Schütt 1896  
*Cerataulina bicornis* (Ehrenberg) Hasle (in Hasle & Sims, 1985)  
 = *Cerataulina compacta* Ostenfeld (in Ostenfeld & Schmidt, 1901)  
 = *Cerataulina daemon* (Greville) Hasle (in Hasle & Syvertsen, 1980)  
*Chaetoceros peruvianus* Brightwell 1856  
 = *Chaetoceros chilensis* Krasske 1941  
*Chaetoceros diadema* (Ehrenberg) Gran 1897b  
 = *Chaetoceros subsecundus* (Grunow) Hustedt 1930

- Chaetoceros minimus* (Levander) Marino, Giuffre, Montresor, & Zingone 1991  
 = *Rhizosolenia minima* Levander 1904  
 = *Monoceros isthmiformis* Van Goor 1924
- Chaetoceros tenuissimus* Meunier 1913  
 = *Chaetoceros simplex* var. *calcitrans* Paulsen 1905  
 = *Chaetoceros galvestonensis* Collier & Murphy 1962  
 = *Chaetoceros calcitrans* f. *pumilus* Takano 1968
- Chaetoceros thronsdensei* var. *thronsdensei* (Marino, Montresor & Zingone) Marino, Giuffre, Montresor, & Zingone 1991  
 = *Miraltia thronsdensei* Marino, Montresor, & Zingone 1987
- Cylindrotheca closterium* (Ehrenberg) Reimann & Lewin 1964  
 = *Nitzschia closterium* (Ehrenberg) W. Smith 1853
- Dactyliosolen blavyanus* (H. Peragallo) Hasle 1975  
 = *Guinardia blavyana* H. Peragallo 1892
- Dactyliosolen fragilissimus* (Bergon) Hasle comb. nov.  
 = *Rhizosolenia fragilissima* Bergon 1903
- Dactyliosolen phuketensis* (Sundström) Hasle comb. nov.  
 = *Rhizosolenia phuketensis* Sundström 1980
- Dactyliosolen tenuijunctus* (Manguin) Hasle 1975  
 = *Rhizosolenia tenuijuncta* Manguin 1957
- Delphineis karstenii* (Boden) G. Fryxell (in Fryxell & Miller, 1978)  
 = *Fragilaria karstenii* Boden 1950
- Delphineis surirella* (Ehrenberg) G. W. Andrews 1981  
 = *Rhaphoneis surirella* (Ehrenberg) Grunow (in Van Heurck, 1881)
- Delphineis surirelloides* (Simonsen) G. W. Andrews 1981  
 = *Rhaphoneis surirelloides* Simonsen 1974
- Detonula pumila* (Castracane) Gran 1900  
 = *Schroederella delicatula* (H. Peragallo) Pavillard 1913  
 = *Thalassiosira condensata* Cleve 1900a
- Ephemera planamembranacea* (Hendey) Paddock 1988  
 = *Navicula planamembranacea* Hendey 1964
- Eucampia antarctica* (Castracane) Mangin 1915  
 = *Eucampia balaustium* Castracane 1886
- Fragilariopsis atlantica* Paasche 1961  
 = *Nitzschia paaschei* Hasle 1974
- Fragilariopsis curta* (Van Heurck) Hustedt 1958a  
 = *Fragilaria curta* Van Heurck 1909  
 = *Nitzschia curta* (Van Heurck) Hasle 1972c

- Fragilariopsis cylindrus* (Grunow) Krieger (in Helmcke & Krieger, 1954)  
 = *Fragilaria cylindrus* Grunow (in Cleve & Möller, 1882)  
 = *Nitzschia cylindrus* (Grunow) Hasle 1972c
- Fragilariopsis cylindriiformis* (Hasle in Hasle & Booth) Hasle 1993  
 = *Nitzschia cylindroformis* Hasle (in Hasle & Booth, 1984)
- Fragilariopsis doliolus* (Wallich) Medlin & Sims 1993  
 = *Synedra doliolus* Wallich 1860  
 = *Pseudoeunotia doliolus* (Wallich) Grunow (in Van Heurck, 1881)
- Fragilariopsis kerguelensis* (O'Meara) Hustedt 1952  
 = *Fragilariopsis antarctica* (Castracane) Hustedt (in A. Schmidt, 1913)  
 = *Nitzschia kerguelensis* (O'Meara) Hasle 1972c
- Fragilariopsis oceanica* (Cleve) Hasle 1965a  
 = *Fragilaria oceanica* Cleve 1873b  
 = *Nitzschia grunowii* Hasle 1972c
- Fragilariopsis pseudonana* (Hasle) Hasle 1993  
 = *Fragilariopsis nana* (Stemann Nielsen) Paasche 1961 *pro parte*  
 = *Nitzschia pseudonana* Hasle 1974
- Fragilariopsis rhombica* (O'Meara) Hustedt 1952  
 = *Nitzschia angulata* Hasle 1972c
- Fragilariopsis ritscheri* Hustedt 1958a  
 = *Nitzschia ritscheri* (Hustedt) Hasle 1972c
- Fragilariopsis separanda* Hustedt 1958a  
 = *Nitzschia separanda* (Hustedt) Hasle 1972c
- Guinardia cylindrus* (Cleve) Hasle comb. nov.  
 = *Rhizosolenia cylindrus* Cleve 1897a
- Guinardia delicatula* (Cleve) Hasle comb. nov.  
 = *Rhizosolenia delicatula* Cleve 1900b
- Guinardia striata* (Stolterfoth) Hasle comb. nov.  
 = *Eucampia striata* Stolterfoth 1879  
 = *Rhizosolenia stolterfothii* H. Peragallo 1888
- Guinardia tubiformis* (Hasle) Hasle comb. nov.  
 = *Rhizosolenia tubiformis* Hasle 1975
- Haslea gigantea* (Hustedt) Simonsen 1974  
 = *Navicula gigantea* Hustedt 1961
- Haslea trompii* (Cleve) Simonsen 1974  
 = *Navicula trompii* Cleve 1901b
- Haslea wawrikan* (Hustedt) Simonsen 1974  
 = *Navicula wawrikan* Hustedt 1961

- Helicotheca tamesis* (Shrubsole) Ricard 1987  
 = *Streptotheca tamesis* Shrubsole 1890
- Lauderia annulata* Cleve 1873a  
 = *Lauderia borealis* Gran 1900
- Leptocylindrus mediterraneus* (H. Peragallo) Hasle 1975  
 = *Dactyliosolen mediterraneus* H. Peragallo 1888
- Lioloma elongatum* (Grunow) Hasle comb. nov.  
 = *Thalassiothrix elongata* Grunow (in Van Heurck, 1881)
- Lioloma delicatulum* (Cupp) Hasle comb. nov.  
 = *Thalassiothrix delicatula* Cupp 1943
- Lioloma pacificum* (Cupp) Hasle comb. nov.  
 = *Thalassiothrix mediterranea* var. *pacifica* Cupp 1943
- Manguinea fusiformis* (Manguin) Paddock 1988  
 = *Tropidoneis fusiformis* Manguin 1957
- Manguinea rigida* (M. Peragallo) Paddock 1988  
 = *Amphiprora rigida* M. Peragallo 1924  
 = *Tropidoneis glacialis* Heiden (in Heiden & Kolbe, 1928)
- Membraneis challengerii* (Grunow, in Cleve & Grunow)  
 Paddock 1988  
 = *Navicula challengerii* Grunow (in Cleve & Grunow, 1880)  
 = *Tropidoneis antarctica* (Grunow, in Cleve & Möller) Cleve 1894b
- Meuniera membranacea* (Cleve) P. C. Silva comb. nov.  
 = *Stauropsis membranacea* (Cleve) Meunier 1910  
 = *Stauroneis membranacea* (Cleve) Hustedt 1959
- Minutocellus polymorphus* (Hargraves & Guillard) Hasle, von Stosch, &  
 Syvertsen 1983  
 = *Bellerochea polymorpha* Hargraves & Guillard 1974
- Navicula granii* (Jørgensen) Gran 1908  
 = *Stauroneis granii* Jørgensen 1905
- Navicula septentrionalis* (Grunow) Gran 1908  
 = *Stauroneis septentrionalis* Grunow 1884  
 = *Navicula quadripedis* Cleve-Euler 1952
- Neodelphineis indica* (F. J. R. Taylor) Hasle (in Hasle & Syvertsen, 1993)  
 = *Synedra indica* F. J. R. Taylor 1967
- Neodenticula seminae* (Simonsen & Kanaya) Akiba & Yanagisawa 1986  
 = *Denticula seminae* Simonsen & Kanaya 1961  
 = *Denticulopsis seminae* (Simonsen & Kanaya) Simonsen 1979
- Nitzschia braarudii* Hasle sp. nov.  
 = *Nitzschia capitata* Heiden (in Heiden & Kolbe, 1928)

- Nitzschia marina* Grunow (in Cleve & Grunow, 1880)  
= *Synedra gaussii* Heiden (in Heiden & Kolbe, 1928)  
= *Pseudo-nitzschia hustedtii* Meister 1937
- Odontella aurita* (Lyngbye) C. A. Agardh 1832  
= *Biddulphia aurita* (Lyngbye) Brébisson (in Brébisson & Godey, 1838)
- Odontella litigiosa* (Van Heurck) Hoban (in Hoban et al., 1980)  
= *Biddulphia litigiosa* Van Heurck 1909
- Odontella longicruris* (Greville) Hoban 1983  
= *Biddulphia longicruris* Greville 1859b
- Odontella mobiliensis* (Bailey) Grunow 1884  
= *Biddulphia mobiliensis* Grunow (in Van Heurck, 1882)
- Odontella sinensis* (Greville) Grunow 1884  
= *Biddulphia sinensis* Greville 1866
- Odontella weissflogii* (Janisch) Grunow 1884  
= *Biddulphia weissflogii* Grunow (in Van Heurck, 1882)  
= *Biddulphia striata* Karsten 1905
- Palmeria hardmaniana* Greville 1865b  
= *Hemidiscus hardmanianus* (Greville) Mann 1907
- Paralia sulcata* (Ehrenberg) Cleve 1873b  
= *Melosira sulcata* (Ehrenberg) Kützing 1844
- Phaeodactylum tricornutum* Bohlin 1897  
= *Nitzschia closterium* (Ehrenberg) W. Smith f. *minutissima* Allen & Nelson 1910
- Plagiogrammopsis vanheurckii* (Grunow) Hasle, von Stosch, & Syvertsen 1983  
= *Plagiogramma vanheurckii* Grunow (in Van Heurck, 1881)
- Plagiotropis gaussii* (Heiden in Heiden & Kolbe) Paddock 1988  
= *Tropidoneis gaussii* Heiden (in Heiden & Kolbe, 1928)
- Planktoniella blanda* (A. Schmidt) Syvertsen & Hasle (in Hasle & Syvertsen, 1993)  
= *Coscinodiscus blandus* A. Schmidt 1878  
= *Coscinodiscus latimarginatus* Guo 1981  
= *Thalassiosira blanda* Desikachary & Gowthaman (in Desikachary, 1989)  
= *Thalassiosira bipartita* (Rattray) Hallegraef 1992
- Planktoniella muriformis* (Loeblich, III, Wight, & Darley) Round 1972  
= *Coenobiodiscus muriformis* Loeblich, III, Wight, & Darley 1968
- Pleurosigma simonsenii* Hasle nom. nov.  
= *Pleurosigma planctonicum* Simonsen 1974
- Porosira pseudodenticulata* (Hustedt) Jousé (in Jousé et al., 1962)  
= *Coscinodiscus pseudodenticulatus* Hustedt 1958a

- Proboscia inermis* (Castracane) Jordan & Ligowski 1991  
 = *Rhizosolenia inermis* Castracane 1886  
 = *Rhizosolenia alata* f. *inermis* (Castracane) Hustedt *sensu* Hendy 1937
- Proboscia truncata* (Karsten) Nöthig & Ligowski 1991  
 = *Rhizosolenia truncata* Karsten 1905  
 = *Rhizosolenia alata* f. *curvirostris* Gran 1900
- Proboscia alata* (Brightwell) Sundström 1986  
 = *Rhizosolenia alata* Brightwell 1858a
- Pseudo-nitzschia australis* Frenguelli 1939  
 = *Nitzschia pseudoseriata* Hasle 1965b
- Pseudo-nitzschia cuspidata* (Hasle) Hasle 1993  
 = *Nitzschia cuspidata* Hasle 1974
- Pseudo-nitzschia delicatissima* (Cleve) Heiden (in Heiden & Kolbe, 1928)  
 = *Nitzschia delicatissima* Cleve 1897a  
 = *Nitzschia actydrophila* Hasle 1965b
- Pseudo-nitzschia fraudulenta* (Cleve) Hasle 1993  
 = *Nitzschia fraudulenta* Cleve 1897b  
 = *Pseudo-Nitzschia seriata* var. *fraudulenta* H. Peragallo (in H. & M. Peragallo, 1900)
- Pseudo-nitzschia heimii* Manguin 1957  
 = *Nitzschia heimii* (Manguin) Hasle 1965b
- Pseudo-nitzschia inflatula* (Hasle) Hasle 1993  
 = *Nitzschia inflatula* Hasle 1974
- Pseudo-nitzschia lineola* (Cleve) Hasle 1993  
 = *Nitzschia lineola* Cleve 1897b  
 = *Nitzschia barkleyi* Hustedt 1952
- Pseudo-nitzschia multiseriis* (Hasle) Hasle 1995  
 = *Pseudo-nitzschia pungens* f. *multiseriis* (Hasle) Hasle 1993  
 = *Nitzschia pungens* f. *multiseriis* Hasle 1974
- Pseudo-nitzschia prolongatoides* (Hasle) Hasle 1993  
 = *Nitzschia prolongatoides* Hasle 1965b
- Pseudo-nitzschia pseudodelicatissima* (Hasle) Hasle 1993  
 = *Nitzschia pseudodelicatissima* Hasle 1976b  
 = *Nitzschia delicatula* Hasle 1965b
- Pseudo-nitzschia pungens* (Grunow ex Cleve) Hasle 1993  
 = *Nitzschia pungens* Grunow ex Cleve 1897a
- Pseudo-nitzschia pungiformis* (Hasle) Hasle 1993  
 = *Nitzschia pungiformis* Hasle 1971



- Pseudo-nitzschia seriata* (Cleve) H. Peragallo (in H. & M. Peragallo, 1900) f. *seriata*  
 = *Nitzschia seriata* Cleve 1883
- Pseudo-nitzschia seriata* f. *obtusa* (Hasle) Hasle 1993  
 = *Nitzschia seriata* f. *obtusa* Hasle 1974
- Pseudo-nitzschia subcurvata* (Hasle) G. Fryxell (in Fryxell et al., 1991)  
 = *Nitzschia subcurvata* Hasle 1964
- Pseudo-nitzschia subfraudulenta* (Hasle) Hasle 1993  
 = *Nitzschia subfraudulenta* Hasle 1974
- Pseudo-nitzschia subpacifica* (Hasle) Hasle 1993  
 = *Nitzschia subpacifica* Hasle 1974
- Pseudo-nitzschia turgidula* (Hustedt) Hasle 1993  
 = *Nitzschia turgidula* Hustedt 1958a
- Pseudo-nitzschia turgiduloides* (Hasle) Hasle 1993  
 = *Nitzschia turgiduloides* Hasle 1965b  
 = *Pseudo-nitzschia barkleyi* var. *obtusa* Manguin 1960 (no Latin diagnosis)
- Pseudosolenia calcar-avis* (Schultze) Sundström 1986  
 = *Rhizosolenia calcar-avis* Schultze 1859
- Rhizosolenia antennata* (Ehrenberg) Brown 1920  
 = *Rhizosolenia hebetata* f. *bidens* Heiden (in Heiden & Kolbe, 1928)
- Rhizosolenia borealis* Sundström 1986  
 = *Rhizosolenia styliformis* var. *oceanica* Wimpenny 1946 *pro parte*
- Rhizosolenia hebetata* f. *hebetata* Bailey 1856  
 = *Rhizosolenia hebetata* f. *hiemalis* Gran 1904
- Rhizosolenia hebetata* f. *semispina* (Hensen) Gran 1904  
 = *Rhizosolenia semispina* Hensen 1887
- Rhizosolenia imbricata* Brightwell 1858a  
 = *Rhizosolenia shrubsolei* Cleve 1881  
 = *Rhizosolenia imbricata* var. *shrubsolei* (Cleve) Schröder 1906
- Rhizosolenia polydactyla* Castracane 1886  
 = *Rhizosolenia styliformis* var. *oceanica* Wimpenny 1946 *pro parte*
- Rhizosolenia styliformis* Brightwell 1858a  
 = *Rhizosolenia styliformis* var. *longispina* Hustedt (in A. Schmidt, 1914)
- Stellarima microtrias* (Ehrenberg) Hasle & Sims 1986b  
 = *Symbolophora microtrias* Ehrenberg 1844b  
 = *Coscinodiscus symbolophorus* Grunow 1884  
 = *Coscinodiscus furcatus* Karsten 1905
- Stellarima stellaris* (Roper) Hasle & Sims 1986b  
 = *Coscinodiscus stellaris* Roper 1858

- Synedropsis hyperborea* (Grunow) Hasle, Medlin, & Syvertsen 1994  
 = *Synedra hyperborea* Grunow 1884  
 = *Synedra hyperborea* var. *flexosa* Grunow 1884  
 = *Synedra hyperborea* var. *rostellata* Grunow 1884
- Thalassionema bacillare* (Heiden, in Heiden & Kolbe) Kolbe 1955  
 = *Spinigera bacillaris* Heiden (in Heiden & Kolbe, 1928)
- Thalassionema frauenfeldii* (Grunow) Hallegraeff 1986  
 = *Thalassiothrix frauenfeldii* (Grunow) Grunow (in Cleve & Grunow, 1880)
- Thalassionema javanicum* (Grunow, in Van Heurck) Hasle comb. nov.  
 = *Thalassiothrix frauenfeldii* var. *javanica* Grunow (in Van Heurck, 1881)
- Thalassionema nitzschioides* (Grunow) Mereschowsky 1902  
 = *Thalassiothrix nitzschioides* Grunow (in Van Heurck, 1881)
- Thalassionema pseudonitzschioides* (Schuette & Schrader) Hasle comb. nov.  
 = *Thalassiothrix pseudonitzschioides* Schuette & Schrader 1982
- Thalassiosira angulata* (Gregory) Hasle 1978a  
 = *Thalassiosira decipiens* (Grunow) Jørgensen 1905 (in Hustedt, 1930; Cupp, 1943)
- Thalassiosira anguste-lineata* (A. Schmidt) G. Fryxell & Hasle 1977  
 = *Coscinodiscus anguste-lineatus* A. Schmidt 1878  
 = *Thalassiosira polychorda* (Gran) Jørgensen 1899  
 = *Coscosira polychorda* (Gran) Gran 1900
- Thalassiosira antarctica* var. *borealis* G. Fryxell, Ducette, & Hubbard 1981  
 = *Thalassiosira fallax* Meunier 1910
- Thalassiosira delicatula* Ostefeld (in Borgert, 1908)  
 = *Thalassiosira coronata* Gaarder 1951  
 non *Thalassiosira delicatula* Hustedt 1958a
- Thalassiosira dichotomica* (Kozlova) G. Fryxell & Hasle 1983  
 = *Porosira dichotomica* Kozlova 1967
- Thalassiosira eccentrica* (Ehrenberg) Cleve 1904  
 = *Coscinodiscus eccentricus* Ehrenberg 1841a
- Thalassiosira gracilis* var. *expecta* (VanLandingham) G. Fryxell & Hasle 1979a  
 = *Thalassiosira delicatula* Hustedt 1958a  
 = *Thalassiosira expecta* VanLandingham 1978
- Thalassiosira guillardii* Hasle 1978b  
 = *Cyclotella nana* Guillard clone 7-15 (in Guillard & Ryther, 1962)
- Thalassiosira hendeyi* Hasle & G. Fryxell 1977b  
 = *Coscinodiscus hustedtii* Müller-Melchers 1953
- Thalassiosira hyperborea* (Grunow) Hasle (in Hasle & Lange, 1989)  
 = *Coscinodiscus (lacustris* var?) *hyperboreus* Grunow 1884

- Thalassiosira lentiginosa* (Janisch, in A. Schmidt) G. Fryxell 1977  
= *Coscinodiscus lentiginosus* Janisch (in A. Schmidt, 1878)
- Thalassiosira leptopus* (Grunow, in Van Heurck) Hasle & G. Fryxell 1977b  
= *Coscinodiscus lineatus* Ehrenberg 1839  
= *Coscinodiscus* (lineatus var.?) *leptopus* Grunow (in Van Heurck, 1883)
- Thalassiosira mediterranea* (Schröder) Hasle 1972b  
= *Coscinosira mediterranea* Schröder 1911  
= *Thalassiosira stellaris* Hasle & Guillard (in Fryxell & Hasle, 1977)
- Thalassiosira minima* Gaarder 1951  
= *Coscinosira floridana* Cooper 1958  
= *Thalassiosira floridana* (Cooper) Hasle 1972b
- Thalassiosira minuscula* Krasske 1941  
= *Thalassiosira monoporocyclus* Hasle 1972a
- Thalassiosira oceanica* Hasle 1983a  
= *Cyclotella nana* Guillard clone 13-1 (in Guillard & Ryther, 1962)
- Thalassiosira oestrupii* (Ostenfeld) Hasle 1972b  
= *Coscinosira oestrupii* Ostenfeld 1900
- Thalassiosira poroseriata* (Ramsfjell) Hasle 1972b  
= *Coscinosira poroseriata* Ramsfjell 1959
- Thalassiosira pseudonana* Hasle & Heimdal 1970  
= *Cyclotella nana* Guillard clone 3H (in Guillard & Ryther, 1962)
- Thalassiosira punctigera* (Castracane) Hasle 1983b  
= *Thalassiosira angstii* (Gran) Makarova 1970
- Thalassiosira ritscheri* (Hustedt) Hasle (in Hasle & Heimdal, 1970)  
= *Coscinodiscus ritscheri* Hustedt 1958a
- Thalassiosira tumida* (Janisch) Hasle (in Hasle et al., 1971)  
= *Coscinodiscus tumidus* Janisch (in A. Schmidt, 1878)
- Thalassiosira weissflogii* (Grunow) G. Fryxell & Hasle 1977  
= *Thalassiosira fluviatilis* Hustedt 1926
- Toxarium hennedyanum* (Gregory) Pelletan 1889  
= *Synedra hennedyana* Gregory 1857
- Toxarium undulatum* Bailey 1854  
= *Synedra undulata* (Bailey) Gregory 1857
- Trichotoxon reinboldii* (Van Heurck) Reid & Round 1988  
= *Synedra reinboldii* Van Heurck 1909  
= *Synedra pelagica* Hendey 1937

## INDEX OF DIATOM TAXA

## Synonyms in boldface

- Achnanthaceae, 10, 26, 269, 271  
 Achnanthales,\* 26  
 Achnanthes, 26  
   *A. taeniata*, 11, 269  
 Actinocyclus, 17, 25, 99, 116, 119  
   *A. actinochilus*, 118–119, 121–122  
   *A. circellus*, 118–119, 121  
   *A. curvatulus*, 118, 121–122  
   *A. ehrenbergii*, 120  
   *A. exiguus*, 118, 122  
   *A. kützingii*, 118–119, 121  
   *A. normanii*, 118, 121  
   *A. normanii* f. *normanii*, 119  
   *A. normanii* f. *subsalsus*, 119  
   *A. octonarius*, 117–118, 120–121  
   *A. octonarius* var. *tenellus*,\* 120  
   *A. sagittulus*, 118, 120–121  
   *A. senarius*, 141  
   *A. spiritus*, 118, 122–123  
   *A. subocellatus*, 121  
   *A. subtilis*, 118, 120–121  
   *A. vestigulus*, 118, 123  
 Actinoptrychus, 25, 140  
   *A. senarius*, 140  
   *A. undulatus*, 140  
 Adoneis, 26, 248  
   *A. pacifica*, 248  
 Amphiprora,\* 289  
   *A. belgicae*, 28  
   *A. rigida*, 287  
 Arcocellulus, 25, 177–178, 183  
   *A. cornucervis*, 179  
   *A. mammifer*, 178–179  
 Asterionella  
   *A. bleakeleyi* var. *notata*, 243  
   *A. frauenfeldii*, 262  
   *A. glacialis*, 241  
   *A. japonica*, 241  
   *A. kariana*, 241, 243  
   *A. socialis*,\* 243  
   *A. synedraeformis*,\* 263  
 Asterionellopsis, 26, 241, 243, 338  
   *A. glacialis*, 243  
   *A. kariana*, 243  
 Asterolampra, 25, 133  
   *A. grevillei*, 133  
   *A. marylandica*, 133  
   *A. roperiana*, 139  
   *A. vanheurckii*, 133  
 Asterolampraceae, 25, 131  
 Asterolamprales,\* 131  
 Asteromphalus, 25, 131  
   *A. arachne*, 137, 140  
   *A. darwinii*,\* 133, 140  
   *A. elegans*, 135, 137, 140  
   *A. flabellatus*, 133, 135  
   *A. heptactis*, 135, 137, 140  
   *A. hookeri*, 139, 140  
   *A. hyalinus*, 135, 139–140  
   *A. parvulus*, 135, 139–140  
   *A. roperianus*, 135, 139–140  
   *A. rossii*,\* 140  
   *A. sarcophagus*, 133, 135, 140  
 Attheya, 184, 221, 225  
   *A. decora*,\* 225  
   *A. longicornis*\*, 225  
   *A. septentrionalis*, 225  
 Attheyaceae,\* 225  
 Aulacodiscaceae,\* 140  
 Aulacodiscus, 140  
   *A. argus*, 141  
 Azpeitia, 25, 98, 116–117, 123  
   *A. africana*, 124, 126  
   *A. antiqva*, 123  
   *A. barronii*, 124, 126, 128  
   *A. neocrenulata*, 124, 126, 128  
   *A. nodulifera*, 126, 128  
   *A. tabularis*, 126, 128  
   *A. temperi*,\* 123  
 Azpeitiaceae,\* 116  
 Bacillaria, 5, 293  
   *B. paradoxa*, 291, 293  
   *B. paxillifera*, 290–291, 293  
 Bacillariaceae, 27, 290, 295  
 Bacillariales, 26  
 Bacillariineae, 26

\* Mentioned in the text but not discussed as a separate item

- Bacillariophyceae, 6
- Bacillariophycidae,\* 26
- Bacterastroidea,\* 190
- Bacteriatrum*, 10–11, 13, 25, 184, 186, 225
- B. comosum*, 188–189
- B. delicatulum*, 186, 189
- B. elongatum*, 188–189
- B. furcatum*, 186, 189
- B. hyalinum*, 186, 188–189
- B. varians*, 186
- Bacterosira*, 23, 31
- B. bathyomphala*, 31, 36–37
- B. fragilis*, 31
- Banquisia*, 27, 272, 284
- B. belgicae*, 284
- Bellerochea*, 26, 225, 227
- B. horologicalis*, 229
- B. horologicalis* var. *recta*, 229
- B. malleus*, 227, 229
- B. polymorpha*, 182
- B. yucatanensis*, 229
- Biddulphia*, 168
- B. aurita*, 236
- B. litigiosa*, 239
- B. longicruris*, 239
- B. mobiliensis*, 239
- B. sinensis*, 239
- B. striata*, 239
- B. weissflogii*, 239
- Biddulphiaceae,\* 97, 184
- Biddulphiales, 23, 27, 177
- Biddulphiineae, 25, 168
- Biddulphiophycidae,\* 236
- Bleakeleya*, 26, 243
- B. notata*, 243
- Brockmanniella*, 25, 177–179, 183
- B. brockmannii*, 179
- Cerataulina*, 25, 169
- C. bergonii*, 169
- C. bicornis*, 171
- C. compacta*, 171
- C. daemon*, 171
- C. dentata*, 171
- C. pelagica*, 168–169, 171
- Cerataulus*
- C. bergonii*, 169
- Ceratoneis*
- C. closterium*, 293
- C. longissima*, 329
- Chaetoceraceae,\* 25, 184, 338
- Chaetoceros*, 6, 10–11, 13, 25, 27, 184, 186, 225, 332, 334, 336, 338
- C. aequatorialis*, 191, 193, 196
- C. affinis*, 190, 193, 218, 220
- C. affinis* var. *willei*\*, 218
- C. anastomosans*, 192, 210
- C. armatus*\*, 184
- C. atlanticus*, 190–191, 196, 198
- C. bactereastroides*, 190
- C. borealis*, 193, 198, 203
- C. borealis* var. *densus*, 201
- C. brevis*\*, 210
- C. calcitrans*\*, 221
- C. calcitrans* f. *pumilus*, 223
- C. castracanei*, 191, 198, 203
- C. ceratosporus*, 193, 221
- C. ceratosporus* var. *brachysetus*, 223
- C. chilensis*, 195
- C. cinctus*, 193, 211, 215
- C. coarctatus*, 191, 198, 203
- C. compressus*, 190, 192, 206–207
- C. compressus* var. *hirtisetus*\*, 206
- C. concavicornis*, 190–191, 198, 201, 203
- C. convolutus*, 190, 198, 203
- C. constrictus*, 190, 192, 209–210
- C. costatus*, 193, 218
- C. criophilus*, 191, 193, 196
- C. curvisetus*, 190, 192, 210–211, 216
- C. dadayi*, 191, 201, 203
- C. danicus*, 191, 194–195
- C. debilis*, 190–192, 211
- C. decipiens*, 190, 192, 204, 206–207
- C. densus*, 191, 201, 203
- C. diadema*, 190, 193, 220
- C. dictyeta*, 189, 191
- C. didymus*, 192, 207, 209–210
- C. distans* var. *subsecundus*, 220
- C. diversus*, 190, 193, 216
- C. eibonii*, 11, 191, 201, 203
- C. externus*, 210
- C. flexuosus*, 192, 203
- C. furcellatus*, 203, 213, 215
- C. galvestonensis*, 223
- C. gracilis*\*, 221
- C. hendeyi*, 203
- C. holsaticus*, 193
- C. karianus*, 193, 221
- C. laevis*, 216
- C. lorenzianus*, 192, 204, 206, 210

- C. lacinosus*, 191–192, 209–210  
*C. lauderi*, 192, 207  
*C. messanensis*, 193, 216  
*C. minimus*, 193, 224  
*C. mitra*, 192, 204, 206–207  
*C. muelleri*,\* 221  
*C. neglectus*, 207  
*C. pelagicus*, 210  
*C. pendulus*, 193  
*C. peruvianus*, 191, 195–196  
*C. protuberans*,\* 209  
*C. pseudocurvisetus*, 192, 211  
*C. radians*, 193, 211, 215, 221  
*C. radicans*, 193  
*C. rostratus*, 191, 196  
*C. seiracanthus*, 193, 220  
*C. septentrionalis*, 184, 225  
*C. similis*, 192, 210  
*C. simplex*, 193, 223  
*C. simplex* var. *calcitrans*, 223  
*C. socialis*, 190, 193, 221  
*C. subsecundus*, 220  
*C. subtilis*, 221, 223  
*C. tenuissimus*, 191, 193, 223  
*C. teres*, 192, 206  
*C. tetrachaeta*,\* 189, 201  
*C. tetrastichon*, 192, 203  
*C. throndsenii*, 193, 224  
*C. throndsenii* var. *throndsenii*, 224  
*C. throndsenii* var. *trisetosus*, 224  
*C. tortissimus*, 215  
*C. nanheurckii*, 210  
*C. wighamii*, 193, 221  
*C. willei*, 218  
Chaetocerotaceae, 184  
Chaetocerotales,\* 184  
Chaetocerotophycidae,\* 93  
*Charcotia*  
*C. actinochila*, 119  
Chromophyta,\* 6  
Chrysophyta,\* 6  
*Climacodium*, 25, 169, 171  
*C. biconcavum*, 172  
*C. frauenfeldianum*, 172  
Coenobiodiscus  
*C. muriformis*, 40, 346  
Cocconeis  
*C. amphiceros*, 252  
Corethraceae,\* 96  
Corethrales,\* 96  
*Corethron*, 23, 96, 338  
*C. criophilum*, 96–97  
*C. inermis*, 97  
Corethrophyceidae,\* 96  
Coscinodiscaceae, 97, 116  
Coscinodiscineae, 23, 28  
*Coscinodiscus*, 23, 27, 98, 334  
*C. actinochilus*, 119  
*C. africanus*, 124  
*C. alboranii*, 102, 106, 110  
*C. anguste-lineatus*, 71  
*C. argus*, 99, 103–105, 109  
*C. asteromphalus*, 102, 104–105  
*C. bathyomphalus*, 31  
*C. bipartita*, 41  
*C. bioculatus*, 80  
*C. blandus*, 40–41  
*C. bouwet*, 97, 103, 109–110  
*C. centralis*, 102, 104–105  
*C. concinniformis*, 102, 105–106, 110  
*C. concinnus*, 98, 102, 105–106  
*C. crenulatus*, 124  
*C. curvatulus*,\* 121–122  
*C. curvatulus* var. *inermis*,\* 122  
*C. curvatulus* var. *genuina*,\* 122  
*C. curvatulus* var. *karianus*,\* 122  
*C. curvatulus* var. *minor*,\* 122  
*C. curvatulus* var. *subocellatus*,  
121–122  
*C. eccentricus*, 62  
*C. furcatus*, 111, 113, 115  
*C. gazellae*, 111  
*C. gracilis*, 82  
*C. granii*, 103, 109–110  
*C. hustedtii*, 62  
*C. hyalinus*, 69  
*C. jonesianus*, 102, 107, 110  
*C. kützingii*, 119  
*C. lacustris*,\* 74  
*C. (lacustris* var.?) *hyperboreus*, 74  
*C. lacustris* var. *pelagicus*,\* 74  
*C. latimarginatus*, 346  
*C. lentiginosus*, 79  
*C. lineatus*, 73, 75  
*C. (lineatus* var.?) *leptopus*, 75  
*C. marginatus*, 102, 107  
*C. medetexraea*, 74  
*C. neocrenulatus*, 124  
*C. nodulifer*, 126  
*C. normanii*, 119

- C. polyacanthus* var. *balticus*, 68  
*C. polychordus*, 71  
*C. praelineatus*, 75  
*C. pseudodenticulatus*, 41  
*C. pseudolineatus*, 75  
*C. radiatus*, 103, 107, 338  
*C. rex*, 111  
*C. ritscheri*, 86  
*C. sol*, 40  
*C. stellaris*, 113  
*C. striatus*, 34  
*C. subglobosus*, 68–69  
*C. (subglobosus* var.?) *antarcticus*, 68  
*C. sublineatus*, \* 73  
*C. subsalsus*, 119  
*C. symbolophorus*, 113, 115  
*C. tabularis*, 126  
*C. trioculatus*, 37  
*C. tumidus*, 70  
*C. walesii*, 98, 102, 105–106, 110
- Coscinosira*
- C. floridana*, 65  
*C. mediterranea*, 74  
*C. oestrupii*, 83  
*C. polychorda*, 71  
*C. poroseriata*, 87
- Creswellia*
- C. palmeriana*, 102  
*C. turris*, \* 102
- Cyclotella*, 23, 30, 33
- C. caspia*, 33, 34  
*C. cryptica*, \* 31  
*C. distinguenda*, \* 31  
*C. litoralis*, 31, 34  
*C. meneghiniana*\*  
*C. nana*, 77, 79  
*C. striata*, 33–34  
*C. stylorum*, 33–34  
*C. tecta*, \* 33
- Cylindrotheca*, 27, 291, 293
- C. closterium*, 184, 270, 290, 294, 329  
*C. gerstenbergeri*, \* 293  
*C. gracilis*, 293
- Cymatosiraceae, 7, 10, 25, 177
- Cymatosirales, \* 177
- Cymatosiropycidae, \* 177
- Cymatosira*, 25, 177–178, 181, 183
- C. belgica*, 182  
*C. lorenziana*, 8, 10, 181–182
- Dactyliosolen*, 25, 141–142, 144, 165
- D. antarcticus*, 165–166, 168  
*D. blavyanus*, 166–167  
*D. fragilissimus*, 166–168, 341  
*D. mediterraneus*, 95  
*D. phuketensis*, 166–168, 341  
*D. tenuijunctus*, 166–167
- Delphineis*, 26, 247–248, 251
- D. angustata*, \* 248  
*D. karstenii*, 249  
*D. surirella*, 249  
*D. surirelloides*, 249
- Denticella*
- D. kamtschatica*, 305  
*D. regia*, 239
- Denticula*
- D. marina*, 305  
*D. seminae*, 305
- Denticulopsis*
- D. seminae*, 305
- Detonula*, 23, 31, 34
- D. confervacea*, 11, 35–36  
*D. moseleyana*, 35–36  
*D. pumila*, 34–37
- Diatoma*, 5
- D. aurita*, 236  
*D. rhombica*, 300
- Diadadia*
- D. antennata*, 147  
*D. groenlandica*, 204  
*D. mitra*, 204
- Ditylum*, 26, 225, 227, 230
- D. brightwellii*, 230–231  
*D. buchananii*, 231  
*D. pernodii*, 231  
*D. sol*, 231  
*D. trigonum*, 230
- Entomoneis*, \* 289
- Ephemera*, 27, 284
- E. planamembranacea*, 272, 284
- Ethmodisaceae, \* 97
- Ethmodiscales, \* 97
- Ethmodiscus*, 23, 97–98, 109
- E. gazellae*, 111  
*E. gigas*, 109  
*E. punctiger*, 59  
*E. rex*, 111
- Eucampia*, 25
- E. antarctica*, 175–176  
*E. antarctica* var. *recta*, \* 176  
*E. balaustium*, 175

- E. cornuta*, 175–176  
*E. groenlandica*, 176  
*E. striata*, 163, 340  
*E. zodiacus*, 172, 175  
*E. zodiacus* f. *cylindricornis*,\* 175  
*Eunotia*  
*E. soleirolii*,\* 11  
Eupodiscaceae, 26, 236  
*Eupodiscus*  
*E. jonesianus*, 107  
*E. subtilis*, 120  
*E. tessellatus*, 130  
*Fasciculigera*,\* 45  
*Fragilaria*,\* 7, 246  
*F. antarctica*  
*F. arctica*, 299  
*F. curta*, 302  
*F. cylindrus*, 302  
*F. karstenii*, 249  
*F. nana*, 300  
*F. oceanica*, 299  
*F. pectinalis*,\* 246  
*F. striatula*, 26, 246  
*F. unipunctata*, 244  
Fragilariaceae, 241  
Fragilariineae, 241  
Fragilariophyceae,\* 26  
*Fragilariopsis*, 27, 246, 269, 290–291,  
295–296, 305, 307, 338  
*F. atlantica*, 298–299, 303  
*F. antarctica*, 294, 296  
*F. curta*, 295–296, 303, 305  
*F. cylindriciformis*, 296, 302–303  
*F. cylindrus*, 295–296, 300, 302, 305  
*F. doliolus*, 296, 303, 305  
*F. kerguelensis*, 294–296, 303, 305  
*F. nana*, 300  
*F. oceanica*, 11, 295–296, 299, 305  
*F. pseudonana*, 296, 300, 305  
*F. rhombica*, 296, 300, 303  
*F. ritscheri*, 296, 297, 303  
*F. separanda*, 296, 301–302  
*Gaillonella*  
*G. sulcata*, 91  
*Gonioceros*  
*G. septentrionalis*, 225  
*Gossleriella*, 25, 115  
*G. tropica*, 116  
Gossleriellaceae,\* 116  
*Guinardia*, 25, 141–142, 144, 160  
*G. blavyana*, 167  
*G. cylindrus*, 161, 165, 340  
*G. delicatula*, 161, 165, 168, 340  
*G. flaccida*, 131, 161, 163, 165  
*G. striata*, 161, 163, 165, 168, 340  
*G. tubiformis*, 161, 165  
*Gyrosigma*, 283  
*G. macrum*, 283  
*Haslea*, 26, 271, 275–276  
*H. gigantea*, 276–277  
*H. gigantea* var. *tenuis*,\* 278  
*H. ostrearia*,\* 275  
*H. trompii*, 278  
*H. wawrikan*, 276, 278  
*Helicotheca*, 26, 226–227, 234, 236  
*H. tamesis*, 234  
Heliopeltaceae, 25, 140  
Hemiaulaceae, 168, 184  
Hemiaulales,\* 168  
*Hemiaulus*, 25, 169, 176  
*H. hauckii*, 177  
*H. indicus*, 177  
*H. membranaceus*, 177  
*H. proteus*,\* 176  
*H. sinensis*, 177  
Hemidiscaceae, 22, 116–117, 130,  
339  
*Hemidiscus*, 25, 116, 128, 131  
*H. cuneiformis*, 128  
*H. hardmanianus*, 107  
*H. kanayanus*, 128  
*Hyalochaete*, 192, 204  
*Hyalosira*  
*H. delicatula*,\* 244  
*Inconspicuae*,\* 45  
*Lanceolatae*, 329  
*Lauderia*, 23, 31, 36  
*L. annulata*, 36–37  
*L. borealis*, 36  
*L. confervacea*, 35  
*L. fragilis*, 31  
*L. moseleyana*, 35  
*L. pumila*, 34  
Lauderiaceae,\* 30  
*Lauderiopsis*, 131  
*L. costata*,\* 131  
*Lennoxia*, 25, 184  
*L. faveolata*, 184, 294  
Leptocylindraceae, 93  
Leptocylindrales,\* 93



- Leptocylindrus*, 23, 27, 93, 131  
   *L. curvatulus*, \*96  
   *L. danicus*, 13, 93, 94–96, 168  
   *L. danicus* var. *adriaticus*, \* 96  
   *L. mediterraneus*, 94–96  
   *L. minimus*, 13, 94–95  
*Lioloma*, 26, 253, 254, 338  
   *L. delicatulum*, 257, 340  
   *L. elongatum*, 254, 257, 338, 340  
   *L. pacificum*, 257, 340  
*Liriogramma*, \* 140  
Lithodesmiaceae, 26, 225–226  
Lithodesmiales, \* 225  
Lithodesmiophycidae, \* 225  
*Lithodesmioides*, 26, 225–227, 231, 234  
   *L. minuta*, 332  
   *L. polymorpha*, 231–232  
*Lithodesmium*, 26, 225–227, 232  
   *L. duckerae*, 233, 234  
   *L. intricatum*, 234  
   *L. undulatum*, 232–233, 234  
   *L. variabile*, 234  
*Manguinea*, 27, 272, 287  
   *M. fusiformis*, 289  
   *M. rigida*, 289  
Melosiraceae, 23, 88, 93  
*Melosira*, 23, 88–89  
   *M. arctica*, 89, 241, 246  
   *M. costata*, 44  
   *M. hyperborea*, 89  
   *M. nummuloides*, 89  
   *M. subsalsa*, 44  
   *M. sulcata*, 91  
*Membraneis*, 27, 272, 286  
   *M. challengerii*, 286–287  
   *M. imposter*, 287  
*Meuniera*, 27  
   *M. membranacea*, 272–273, 339–340  
Micropodiscus  
   *M. weissflogii*, 75  
*Microtabella*, \* 244  
*Minidiscus*, 23, 30, 37, 39  
   *M. comicus*, 37  
   *M. chilensis*, 37, 39  
   *M. trioculatus*, 37, 39  
*Minutocellus*, 25, 177–178, 182–183  
   *M. polymorphus*, 182–183  
   *M. scriptus*, 182–183  
*Miraltia*  
   *M. thronsdensii*, 224  
*Möllera*  
   *M. cornuta*, 175  
Monoceros  
   *M. isthmiiiformis*, 224  
*Nanoneis*, 27, 271  
   *N. hasleae*, 271  
*Navicula*, 27, 269, 272, 275, 278, 334  
   *N. angulata*  
   *N. challengerii*, 287  
   *N. derasa*, 280  
   *N. directa*, 272, 278, 280  
   *N. distans*, 272, 280–281  
   *N. gigantea*, 274  
   *N. granii*, 272, 275  
   *N. (Stauroneis) membranacea*, 273, 340  
   *N. ostrearia*, \* 275  
   *N. pelagica*, 272–273, 275  
   *N. planamembranacea*, 284  
   *N. quadripedis*, 275  
   *N. septentrionalis*, 272, 275  
   *N. transitans* var. *derasa*, 272, 278, 280  
   *N. transitans* var. *derasa* f. *delicatula*,  
     272, 278, 281  
   *N. trompii*, 272  
   *N. vanhoeffenii*, '271–272  
   *N. wawrikan*, 278  
Naviculaceae, 27, 271–272  
*Naviculae*  
   *N. fusiformes*, \* 271  
Naviculales, \* 26  
*Neodelphineis*, 26, 247, 249, 251  
   *N. indica*, 249  
   *N. pelagica*, 247, 249  
*Neodenticula*, 27, 290–291, 305  
   *N. kamtschatica*, 305  
   *N. seminae*, 306  
*Neostreptothea*, 26, 225, 227, 235  
   *N. subindica*, 235–236  
   *N. torta*, 236  
   *N. torta* f. *torta*, \* 236  
   *N. torta* f. *triangularis*, \* 236  
Nitzschiaceae, \* 290  
*Nitzschia*, 27, 269, 290–291, 295, 307,  
   323–324, 328  
   *N. actydropbila*, 316  
   *N. americana*, 324  
   *N. angulata*, 300  
   *N. angusta* var. *marina*, 330  
   *N. angustata* var. *marina*, 330  
   *N. barkleyi*, 317

- N. bicapitata*, 330–331  
*N. bifurcata*,\* 330  
*N. braarudii*, 330–331, 339  
*N. capitata*, 319, 330–331  
*N. closterium*, 184, 230, 290, 293, 294  
*N. closterium* f. *minutissima*, 269, 271  
*N. curta*, 302  
*N. cuspidata*, 319  
*N. cylindriciformis*, 302  
*N. cylindrus*, 302  
*N. delicatissima*, 316–317, 323  
*N. delicatula*, 321  
*N. fraudulentata*, 313  
*N. granii*, 321  
*N. granii* var. *curvata*, 321  
*N. grunowii*, 299  
*N. heimii*, 314  
*N. inflatula*, 321  
*N. kerguelensis*, 296  
*N. kolaczekii*, 328–329  
*N. lineola*, 317  
*N. longissima*, 294, 324, 329–330  
*N. marina*, 328–329  
*N. migrans*, 327  
*N. multistriata*,\* 323  
*N. paaschei*, 297  
*N. paradoxa*, 293  
*N. prolongata*, 317  
*N. prolongatoides*, 317  
*N. pseudodelicatissima*, 321  
*N. pseudonana*, 300  
*N. pseudoseriata*, 311  
*N. pungens*, 312  
*N. pungens* f. *multiseries*, 312  
*N. pungiformis*, 313  
*N. ritscheri*, 247  
*N. separanda*, 300  
*N. seriata*, 305, 310–311, 316  
*N. seriata* f. *obtusa*, 311  
*N. sicula*, 305, 329  
*N. sicula* var. *bicuneata*, 325, 327  
*N. sicula* var. *migrans*, 325, 327  
*N. sicula* var. *rostrata*, 327  
*N. sicula* var. *sicula*, 325, 327  
*N. sigmoidea*,\* 300  
*N. subcurvata*, 321  
*N. subfraudulenta*, 313  
*N. subpacificata*, 314  
*N. turgidula*, 319  
*N. turgiduloides*, 319  
*Nitzschiella*, 330  
*Odontella*, 26, 168, 236  
*O. aurita*, 236, 239  
*O. litigiosa*, 239  
*O. longicruris*, 239  
*O. mobiliensis*, 239  
*O. regia*, 239  
*O. sinensis*, 239  
*O. weissflogii*, 239  
*Orthosira*  
*O. angulata*, 51  
*O. marina*, 89  
*Pachyneis*, 27, 271–272, 290  
*P. gerlachii*, 289–290  
*Palmeria*, 23, 97, 111–112  
*P. hardmaniana*, 111–112  
*P. ostenfeldii*, 112–113  
*Paralia*, 10, 86–87  
*P. marina*, 89  
*P. sulcata*, 91  
Paraliaceae,\* 88  
Paraliales,\* 88  
*Phaeoceros*, 190–191, 193, 204  
*Phaeocystis*,\* 321, 323  
Phaeodactylaceae, 26, 269, 271  
*Phaeodactylum*, 26, 269  
*P. tricornutum*, 269, 271, 294  
*Pinnularia*  
*P. directa*, 278  
*P. distans*, 280  
*Plagiogramma*  
*P. brockmannii*, 179  
*P. vanheurckii*, 183  
*Plagiogrammopsis*, 25, 177–178, 183  
*P. vanheurckii*, 183  
*Plagiotropis*, 27, 271–272, 289  
*P. baltica*, 289  
*P. gaussii*, 289  
*Planktoniella*, 23, 30, 39  
*P. blanda*, 40  
*P. muriformis*, 40  
*P. sol*, 40  
Planktoniellaceae, 30  
*Pleurosigma*, 27, 272, 281, 338  
*P. angulatum*,\* 281  
*P. directum*, 272, 281–282  
*P. normanii*, 272, 281–282  
*P. planctonicum*, 282, 339  
*P. simonsenii*, 272, 281–282, 339  
*Podosira*  
*P. hormoides* var. *glacialis*, 41  
*P. (?) subtilis*, 58

- Porosira*, 17, 23, 31, 41  
*P. denticulata*, 41, 43  
*P. dichotomica*, 65  
*P. glacialis*, 41, 43  
*P. pentaportula*, 41, 43  
*P. pseudodenticulata*, 41, 43  
*Proboscia*, 25, 141–142, 159  
*P. alata*, 159  
*P. eumorpha*, 159  
*P. inermis*,\* 159  
*P. subarctica*, 159  
*P. truncata*,\* 159  
*Pseudoeunotia*  
*P. doliolus*, 303  
*Pseudoguinaridia*, 25, 130  
*P. recta*, 130–131  
*Pseudo-nitzschia*, 27, 290, 306–307,  
310–312, 323, 328, 333, 334, 338  
*P. australis*, 309, 311–312, 315–316  
*P. barkleyi* var. *obtusata*, 319  
*P. cuspidata*, 309, 319, 323  
*P. delicatissima*, 307, 309–310, 317,  
323, 324  
*P. fraudulentata*, 308–309, 313, 315  
*P. granii*, 309–310, 321, 323  
*P. granii* var. *curvata*, 321  
*P. granii* var. *granii*, 321  
*P. heimii*, 308–309, 314–316  
*P. hustedtii*, 328  
*P. inflatula*,\* 309–310, 321, 323  
*P. lineola*, 309–310, 317, 323  
*P. multiseriata*, 324  
*P. multiseriata*, 307, 309, 312, 315  
*P. prolongatoides*, 309–310, 317, 323  
*P. pseudodelicatissima*, 307, 309–310,  
317, 321, 323  
*P. pungens*, 308–309, 312, 315  
*P. pungens* f. *multiseriata*, 312  
*P. pungiformis*, 309, 313, 315  
*P. seriata*, 306, 308–310, 312  
*P. seriata* f. *obtusata*, 311, 315  
*P. seriata* f. *seriata*, 315  
*P. seriata* var. *fraudulentata*, 305, 313  
*P. sicula*,\* 328  
*P. sicula* var. *bicuneata*, 305, 327  
*P. sicula* var. *migrans*, 305, 327  
*P. subcurvata*, 309–310, 323  
*P. subfraudulentata*,\* 308–309, 315  
*P. subpacifica*, 308–309, 315  
*P. turgidula*, 308, 310, 319, 323  
*P. turgiduloides*,\* 309–310, 323  
*Pseudopodosiraceae*,\* 88  
*Pseudosolenia*, 25, 141–142, 160  
*P. calcar-avis*, 160  
*Pyxidicula*,\* 92  
*P. aculeata*,\* 91  
*P. mediterranea*,\* 92  
*Pyxidiculaceae*,\* 88  
*Pyxillaceae*,\* 93  
*Rhaphoneidaceae*, 26, 247, 252  
*Rhaphoneis*, 26, 247, 251  
*R. amphicerus*, 251  
*R. angustata*, 248  
*R. surirella*, 343  
*R. surirelloides*, 249  
*R. (Diatoma?) bicuneata*, 249  
*Rhizomonas*  
*R. setigera*, 94  
*Rhizosolenia*, 6, 25, 27, 141, 144, 338  
*R. acicularis*, 144, 147  
*R. acuminata*, 146, 153, 155  
*R. alata*, 159  
*R. antennata* f. *antennata*, 144, 147,  
150  
*R. antennata* f. *semispina*, 149–150  
*R. arafurensis*,\* 159  
*R. bergonii*, 146, 155  
*R. bidens*, 147  
*R. borealis*, 144, 147  
*R. calcar-avis*, 160  
*R. castracanei*, 146, 155  
*R. castracanei* var. *castracanei*, 151  
*R. castracanei* var. *neglecta*, 151  
*R. clevei*, 146, 150, 155  
*R. clevei* var. *clevei*, 151  
*R. clevei* var. *communis*, 151  
*R. crassa*, 146, 150–151, 155  
*R. curva*, 147  
*R. curvata*, 144, 147  
*R. cylindrus*, 161, 340  
*R. debyana*, 146, 151, 155  
*R. decipiens*, 146, 156  
*R. delicatula*, 161, 340  
*R. fallax*, 146, 156  
*R. (?) flaccida*, 161  
*R. formosa*, 144, 146  
*R. fragilissima*, 167, 341  
*R. hebetata*, 141  
*R. hebetata* f. *bidens*, 147  
*R. hebetata* f. *hebetata*, 149  
*R. hebetata* f. *hiemalis*, 149

- R. hebetata* f. *semispina*, 149, 150  
*R. hyalina*, 146, 151, 155  
*R. imbricata*, 146, 155–156  
*R. imbricata* var. *shrubsolei*, 155  
*R. indica*, \* 159  
*R. inermis*, 159  
*R. minima*, 224  
*R. ostensfeldii*, 146, 155  
*R. pellucida*, 151  
*R. polydactyla*, 144  
*R. polydactyla* f. *polydactyla*, 150  
*R. polydactyla* f. *squamosa*, 150  
*R. phuketensis*, 167, 341  
*R. pungens*, 146, 157  
*R. robusta*, 146, 158–159  
*R. semispina*, 149  
*R. setigera*, 146, 157  
*R. shrubsolei*, 155  
*R. sima* f. *sima*, 144, 150  
*R. sima* f. *silicea*, 150  
*R. simplex*, 146, 155  
*R. stolterfothii*, 163, 340  
*R. striata*, 146, 156  
*R. styliiformis*, 144, 146–147  
*R. styliiformis* f. *latissima*, 146  
*R. styliiformis* var. *longispina*, 146  
*R. styliiformis* var. *oceanica*, 147, 150  
*R. temperi*, 146, 151, 155  
*R. temperi* var. *acuminata*, 153  
*R. tenuijuncta*, 167  
*R. truncata*, 159  
*R. tubiformis*, 163  
Rhizosoleniaceae, 25, 116, 141, 142  
Rhizosoleniales, \* 93, 141  
Rhizosoleniineae, 25, 141  
Rhizosoleniophycidae, \* 141  
*Roperia*, 25, 116–117, 130  
*R. tessellata*, 130  
  
*Sargassum*, \* 252  
*Schroederella*  
*S. delicatula*, 34  
*Skeletonema*, 10, 23, 31, 43, 338  
*S. barbadense*, \* 43–44  
*S. costatum*, 44–45, 186  
*S. menzelii*, 44–45  
*S. pseudocostatum*, 45  
*S. subsalsum*, 44–45  
*S. tropicum*, 44  
Skeletonemataceae, \* 30  
  
*Skeletonemopsis*, 44  
*Solenicola setigera*, 44  
*Spatangidium*, \* 140  
*S. arachne*, 137, 140  
*S. flabellatum*, 135  
*S. heptactis*, 137  
*Spinigera*  
*S. bacillaris*, 262  
*Stauroneis*  
*S. granii*, 275  
*S. membranacea*, 273  
*S. septentrionalis*, 275  
*Stauropsis*, 273, 284  
*S. granii*, 275  
*S. membranacea*, 273  
*S. pelagica*, 275  
*S. vanhoeffenii*  
*Stellarima*, 11, 25, 113  
*S. microtrias*, 113, 115  
*S. stellaris*, 113, 115  
Stellarimaceae, 25, 113, 115–116  
Stephanodiscoaceae, \* 30  
*Stephanopyxis*, 20  
*S. nipponica*, 92–93  
*S. palmeriana*, 92–93  
*S. turris*, 45, 92–93  
Stephanopyxidaceae, \* 88  
Stictodiscoideae, \* 97  
*Streptothecha*, 225–226  
*S. tamesis*, 234  
Streptotheceaceae, \* 226  
*Striatella*, 26, 241, 244  
*S. unipunctata*, 244  
*Symbolophora*  
*S.?* *microtrias*, 113  
*S. furcata*, 113  
Symbolophoraceae, \* 116  
*Syndendrium*  
*S. diadema*, 220  
*Synedra*  
*S. doliolus*, 303  
*S. gausсии*, 328  
*S. hennedyana*, 252  
*S. hyperborea*, 246, 333  
*S. hyperborea* var. *flexosa*, 246  
*S. hyperborea* var. *rostellata*, 246  
*S. indica*, 251  
*S. nitzschoides*, 257  
*S. pelagica*, 267  
*S. reinboldii*, 267

- S. sicula*, 327  
*S. thalassiothrix*, 263  
*S. undulata*, 252  
*Synedropsis*, 26, 241, 246  
*S. hyperborea*, 241, 246–247  
*S. hyperboreoides*, \* 247  
*S. recta*, \* 247  
*Syringidium*  
*S. bicornis*, 171  
*Tangentales*, \* 45  
*Terebraria*  
*T. kerguelensis*, 296  
*Tessella*  
*T. interrupta*, \* 244  
*Thalassionema*, 253, 256, 338  
*T. bacillare*, 262, 267  
*T. frauenfeldii*, 262, 267  
*T. javanicum*, 262, 340  
*T. nitzschoides*, 257, 262, 311  
*T. pseudonitzschoides*, 262, 340  
*Thalassionemataceae*, 26, 253  
*Thalassiosira*, 6–7, 11, 23, 26–27, 31, 45, 98, 334, 338  
*T. aestivalis*, 48, 56, 59  
*T. allenii*, 48, 51, 59  
*T. angstii*, 58  
*T. angulata*, 48, 51, 57, 59, 61, 70, 73  
*T. anguste-lineata*, 50, 71, 75  
*T. antarctica*, 11, 50, 69  
*T. antarctica* var. *antarctica*, 66, 71  
*T. antarctica* var. *borealis*, 66, 68, 71  
*T. australiensis*, \* 74  
*T. australis*, 11, 13, 50, 71, 75  
*T. baltica*, 68, 71  
*T. binata*, \* 48, 50, 56, 59, 65  
*T. bioculata*, 50, 80, 82, 84, 86  
*T. bipartita*, 41  
*T. blanda*, 40  
*T. bramaputrae*, \* 74  
*T. bulbosa*, 48, 52–53, 59  
*T. chilensis*, \* 61  
*T. condensata*, 34, 36  
*T. conferta*, 48, 54, 56, 59, 65  
*T. confusa*, \* 50, 87–88  
*T. constricta*, \* 50, 69–71  
*T. coronata*, 59  
*T. curviseriata*, 50, 63, 65  
*T. decipiens*, \* 48  
*T. decipiens*, 8, 48, 51  
*T. delicatula*, 50, 59, 63, 83  
*T. dichotomica*, 50, 63  
*T. diporocyclus*, 50, 56, 61, 63  
*T. eccentrica*, 50, 52, 62–63  
*T. endoseriata*, 50, 86–87  
*T. expecta*, 83  
*T. fallax*, 66  
*T. ferelineata*, \* 48, 59  
*T. floridana*, 65  
*T. fluviatilis*, 75  
*T. fragilis*, \* 50, 56, 63  
*T. frenguelli*, \* 50, 87  
*T. gerloffii*, \* 50, 70–71, 73  
*T. gessneri*, \* 74  
*T. gracilis*, 50, 82, 86  
*T. gracilis* var. *gracilis*, 83  
*T. gracilis* var. *expecta*, 83  
*T. gravida*, 50, 68–70  
*T. guillardii*, 50, 77  
*T. hendeyi*, 50, 61–62  
*T. hibernalis*, \* 59  
*T. hispida*, \* 48, 56, 59  
*T. hyalina*, 50, 69–71  
*T. hyperborea*, 50, 74–75  
*T. hyperborea* var. *hyperborea*, \* 74  
*T. hyperborea* var. *pelagica*, \* 74  
*T. karenae*, \* 50, 69, 71  
*T. kushirensis*, \* 50, 73, 75  
*T. lacustris*, \* 74  
*T. latimarginata*, \* 87  
*T. lentiginosa*, 50, 79–80  
*T. leptopus*, 50, 75  
*T. licea*, \* 48, 58–59  
*T. lineata*, 50, 80  
*T. lineoides*, \* 50, 80  
*T. lundiana*, \* 58  
*T. mala*, 48, 54, 59  
*T. mediterranea*, 50, 74–75  
*T. mendiolana*, 50, 62, 63  
*T. minima*, 50, 65  
*T. minuscula*, 48, 54, 56, 58–59  
*T. monoporocyclus*, 54  
*T. nordenskiöldii*, 11, 45, 48, 51, 56, 59, 65  
*T. oceanica*, 48, 57, 59, 79  
*T. oestrupii*, 50, 83, 86  
*T. oestrupii* var. *oestrupii*, \* 83  
*T. oestrupii* var. *venrickae*, \* 83  
*T. pacifica*, 48, 57, 59, 61, 70  
*T. partheneia*, 48, 57, 59  
*T. perpusilla*, 50, 83–84, 86

- T. polychorda*, 71  
*T. poro-irregularata*, 50, 88  
*T. poroseriata*, 50, 86–87  
*T. proschkinae*, 50, 84, 86  
*T. proschkinae* var. *spiculata*,\* 84  
*T. pseudonana*, 50, 79  
*T. punctigera*, 48, 58–59  
*T. ritscheri*, 50, 86, 88  
*T. rosulata*,\* 50, 84, 86  
*T. rotula*, 10, 50, 70–71  
*T. simonsenii*, 41, 50, 63  
*T. spinulata*,\* 84  
*T. stellaris*, 74  
*T. subtilis*, 48, 56, 58–59  
*T. tealata*,\* 50, 65  
*T. tenera*, 48, 59  
*T. trifulta*, 50, 87–88  
*T. tumida*, 50, 70–71  
*T. weissflogii*, 50, 74–75  
Thalassiosiraceae, 23, 74–75  
Thalassiosirales,\* 30  
Thalassiosirophycidae,\* 30  
*Thalassiothrix*, 26, 253, 263, 267, 332, 338  
*T. acuta*,\* 263  
*T. antarctica*, 264  
*T. delicatula*, 340  
*T. elongata*, 254, 257, 340  
*T. (fauenfeldii* var.) *javanica*, 340  
*T. gibberula*, 266–267, 339  
*T. heteromorpha*,\* 263  
*T. heteromorpha* var. *mediterranea*,\* 263  
*T. lanceolata*,\* 266  
*T. longissima*, 263, 266  
*T. mediterranea*,\* 263  
*T. mediterranea* var. *pacifica*, 254, 340  
*T. nitzschioides*, 257  
*T. pseudonitzschioides*, 262, 340  
*T. vanhoeffenii*,\* 254, 257  
*Thalassotrix*  
Toxariaceae, 252  
*Toxarium*, 26  
*T. hennedyanum*, 252–253  
*T. undulatum*, 252–253  
Triceratiaceae,\* 236  
Triceratiales,\* 236  
*Triceratium*, 231  
*T. brightwellii*, 231  
*T. intricatum*, 234  
*T. malleus*, 227  
*T. sol*, 231  
*Trichotoxon*, 26, 253, 267  
*T. reinboldii*, 267  
Tripodiscus  
*T. argus*, 141  
*Tropidoneis*, 271–272, 283, 284  
*T. antarctica*, 287  
*T. belgicae*, 286  
*T. fusiformis*, 287  
*T. glacialis*, 289  
*T. gaussii*, 289  
*Tryblionella*,\* 329  
Urosolenia, 141  
*Vibrio ostrearius*, 275  
*Vibrio paxillifer*, 293  
Xanthophyceae,\* 6  
Zygoceros  
*Z. (Denticella?) mobiliensis*, 239  
*Z. surirella*, 249

## REFERENCES

- Agardh, C. A. 1832. "Conspectus criticus diatomacearum," Vol. 4, pp. 49–66. Berlingianiis, Lund.  
Akiba, F., & Yanagisawa, Y. 1986. 7. Taxonomy, morphology and phylogeny of the Neogene diatom zonal marker species in the middle-to-high latitudes of the North Pacific. In "Initial Reports of the Deep Sea Drilling Project" (H. Kagami, D. E. Karig, W. T. Coulborn, *et al.*, eds.), Vol. 87, pp. 483–554.  
Allen, E. J., & Nelson, E. W. 1910. On the artificial culture of marine plankton. *Journal of the Marine Biological Association of the United Kingdom* 8:421–474.

- Allen, W. E., & Cupp, E. E. 1935. Plankton diatoms of the Java Sea. *Annales du Jardin Botanique de Buitenzorg* 44(2):101–174.
- Andersen, R. A., Medlin, L. K., & Crawford, R. M. 1986. An investigation of the cell wall components of *Actinocyclus subtilis* (Bacillariophyceae). *Journal of Phycology* 22:466–479.
- Andrews, G. W. 1977. Morphology and stratigraphic significance of *Delphineis*, a new marine diatom genus. *Beiheft zur Nova Hedwigia* 54:243–260.
- Andrews, G. W. 1981. Revision of the diatom genus *Delphineis* and morphology of *Delphineis surirella* (Ehrenberg) G. W. Andrews, n. comb. In “Proceedings of the 6th Symposium on Recent and Fossil Diatoms” (R. Ross, ed.), pp. 81–90. Koeltz, Koenigstein.
- Andrews, G. W., & Rivera, P. 1987. Morphology and evolutionary significance of *Adoneis pacifica* gen. et sp. nov. *Diatom Research* 2:1–14.
- Anonymous, 1975. Proposals for a standardization of diatom terminology and diagnoses. *Beiheft zur Nova Hedwigia* 53:323–354.
- Bailey, J. W. 1851. Microscopical observations made in South Carolina, Georgia and Florida. *Smithsonian Contributions to Knowledge* 2(8):1–48.
- Bailey, J. W. 1854. Notes of new American species and localities of microscopical organisms. *Smithsonian Contributions to Knowledge* 7(3):1–16.
- Bailey, J. W. 1856. Notice of microscopic forms found in the soundings of the Sea of Kamtschatka. *The American Journal of Science and Arts Second Series* 22:1–6.
- Bailey, L. W. 1861. Notes on new species of microscopical organisms, chiefly from the Para River, South America. *Boston Journal of Natural History* 7(3):329–352.
- Barber, H. G., & Haworth, E. Y. 1981. A guide to the morphology of the diatom frustule. *Freshwater Biological Association Scientific Publication* 44:1–112.
- Bates, S. S., Bird, C. J., Freitas, A. S. W. De, Foxall, R., Gilgan, M., Hanic, L. A., Johnson, G. R., McCulloch, A. W., Odense, P., Pocklington, R., Quilliam, M. A., Sim, P. G., Smith, J. C., Subba Rao, D. V., Todd, E. C. D., Walter, J. A., & Wright, J. L. C. 1989. Pennate diatom *Nitzschia pungens* as the primary source of domoic acid, a toxin in shellfish from Eastern Prince Edward Island, Canada. *Canadian Journal of Fisheries and Aquatic Sciences* 46:1203–1215.
- Bergon, P. 1903. Études sur la flora diatomique du bassin d’Arcachon et des parages de l’Atlantique voisins des cette station. *Bulletin de la Société Scientifique d’Arcachon* 6:39–112.
- Bethge, H. 1928. Über die Kieselsalge *Skeletonema subsalsum*. *Berichte der deutschen botanischen Gesellschaft* 46:340–347.
- Boalch, G. T. 1971. The typification of the diatom species *Coscinodiscus concinnus* Wm. Smith and *Coscinodiscus granii* Gough. *Journal of the Marine Biological Association of the United Kingdom* 51:685–695.
- Boalch, G. T. 1975. The Lauder species of the diatom genus *Bacteriastrum*. *Beiheft zur Nova Hedwigia* 53:185–189.
- Boalch, G. T., & Harbour, D. S. 1977. Observations on the structure of a planktonic *Pleurosigma*. *Beiheft zur Nova Hedwigia* 54:275–280.
- Boden, B. P. 1950. Some marine diatoms from the west coast of South Africa. *Transactions of the Royal Society of South Africa* 32:321–434.
- Bohlin, K. 1897. Zur Morphologie und Biologie einzelliger Algen. *Öfversigt af Kongliga Vetenskaps-Akademiens Förhandlingar 1897* 54(9):507–529.
- Booth, B. C., Lewin, J., & Norris, R. E. 1982. Nanoplankton species predominant in the subarctic Pacific in May and June 1978. *Deep-Sea Research* 29:185–200.
- Borgert, A. 1908. Bericht über eine Reise nach Ostafrika und dem Victoria Nyansa nebst Bemerkungen über einen kurzen Aufenthalt auf Ceylon. *Sitzungsberichte der naturwissenschaftlichen Abteilung der Niederrheinischen Gesellschaft für Natur- und Heilkunde zu Bonn* 1907:12–33.

- Boyer, C. S. 1927. Synopsis of North American Diatomaceae. *Proceedings of the Academy of Natural Sciences of Philadelphia* 78 (1926 Supplement):1–228.
- Braarud, T. 1935. The “Øst” Expedition to the Denmark Strait 1929. II. The phytoplankton and its conditions of growth. *Hvalrådets Skrifter* 10:1–173.
- Brightwell, T. 1856. On the filamentous, long-horned diatomacæ, with a description of two new species. *Quarterly Journal of Microscopical Science* 4:105–109.
- Brightwell, T. 1858a. Remarks on the genus “Rhizosolenia” of Ehrenberg. *Quarterly Journal of Microscopical Science* 6:93–95.
- Brightwell, T. 1858b. Further observations on the genera *Triceratium* and *Chaetoceros*. *Quarterly Journal of Microscopical Science* 6:153–155.
- Brightwell, T. 1860. On some of the rarer or undescribed species of diatomacæ. Part II. *Quarterly Journal of Microscopical Science* 8:93–96.
- Brooks, M. 1975. Studies on the genus *Coscinodiscus* I–III. *Botanica Marina* 18:1–13, 15–27, 29–39.
- Brown, N. E. 1920. New and old diatoms from the Antarctic regions. *English Mechanic and World of Science* 111:210–211, 219–220, 232–233.
- Brun, J. 1891. Diatomées espèces nouvelles marines, fossiles ou pélagiques. *Mémoires de la Société de physique et d’histoire naturelle de Genève* 31, *Seconde partie* 1:1–47.
- Buck, K. R., Uttal-Cooke, L., Pilskaln, C. H., Roelke, D. L., Villac, M. C., Fryxell, G. A., Cifuentes, L., & Chaves, F. P. 1992. Autecology of the diatom *Pseudo-nitzschia australis*, a domoic acid producer, from Monterey Bay, California. *Marine Ecology Progress Series* 84: 293–302.
- Cardinal, A., Poulin, M., & Bérard-Therriault, T. 1989. New criteria for species characterization in the genera *Donkinia*, *Gyrosigma* and *Pleurosigma* (Naviculaceae, Bacillariophyceae). *Phycologia* 28:15–27.
- Castracane, F. 1875. Contribuzione alla florula delle diatomee del Mediterraneo ossia esame del contenuto nello stomaco di una Salpa pinnata, pescata a Messina. *Atti dell’Accademia Pontificia de’Nuovi Lincei* 28:377–396.
- Castracane, F. 1886. Report on the diatomacæ collected by H.M.S. Challenger during the years 1873–1876. Report on the scientific Results of the voyage of H.M.S. Challenger during the Years 1873–76. Botany 2(4):I–III, 1–178.
- Chang, Tsang-Pi, & Steinberg, C. 1989. Identifizierung von nanoplanktischen Kieselalgen (Centrales, Bacillariophyceae) in der Rott und im Rott–Stausee (Bayern, Bundesrepublik Deutschland). *Archiv für Protistenkunde* 137:111–129.
- Cleve, P. T. 1873a. Examination of diatoms found on the surface of the Sea of Java. *Bihang till Kongliga Svenska Vetenskaps-Akademiens Handlingar* 1(11):1–13.
- Cleve, P. T. 1873b. On diatoms from the arctic Sea. *Bihang till Kongliga Svenska Vetenskaps-Akademiens Handlingar* 1(13):1–28.
- Cleve, P. T. 1881. On some new and little known diatoms. *Kongliga Svenska Vetenskaps-Akademiens Handlingar* 18(5):1–28.
- Cleve, P. T. 1883. Diatoms collected during the expedition of the Vega. *Vega-Expeditionens Vetenskapliga Iakttagelser* 3:455–517.
- Cleve, P. T. 1889. Pelagiske diatomeer från Kattegat. *Det évidenskabelige Udbytte af Kanonbaaden “Hauchs” Togter i de danske Have indenfor Skagen i Aarene 1883–86*:53–56.
- Cleve, P. T. 1894a. Planktonundersökningar. *Bihang till Kongliga Svenska Vetenskaps-Akademiens Handlingar* 20(3,2):1–16.
- Cleve, P. T. 1894b. Synopsis of the naviculoid diatoms. *Kongliga Svenska Vetenskaps-Akademiens Handlingar* 26(2):1–194.
- Cleve, P. T. 1896a. Diatoms from Baffins Bay and Davis Strait. *Bihang till Kongliga Svenska Vetenskaps-Akademiens Handlingar* 22(3,4):1–22.



- Cleve, P. T. 1896b. Redogörelse för de svenska hydrografiske undersökningarne februari 1896. V. Planktonundersökningar: Vegetabiliskt plankton. *Bihang till Kongliga Svenska Vetenskaps-Akademiens Handlingar* 22(5):1–33.
- Cleve, P. T. 1897a. "A treatise on the phytoplankton of the *Atlantic and its tributaries*," pp. 28. Uppsala, Sweden.
- Cleve, P. T. 1897b. Report on the phytoplankton collected on the expedition of H.M. S. "Research" 1896. *Fifteenth Annual Report of the Fishery Board for Scotland* 3:296–304.
- Cleve, P. T. 1900a. Notes on some Atlantic plankton-organisms. *Kongliga Svenska Vetenskaps-Akademiens Handlingar*. 34(1):1–22.
- Cleve, P. T. 1900b. The plankton of the North Sea, the English Channel, and the Skagerak in 1898. *Kongliga Svenska Vetenskaps-Akademiens Handlingar* 32(8):1–53.
- Cleve, P. T. 1900c. The seasonal distribution of Atlantic plankton organisms. *Göteborgs Kungliga Vetenskaps- och Vitterhets-Samhälles Handlingar Fjärde följden* 3:1–369.
- Cleve, P. T. 1901a. Plankton from the Indian Ocean and the Malay Archipelago. *Kongliga Svenska Vetenskaps-Akademiens Handlingar* 35(5):11–58.
- Cleve, P. T. 1901b. Plankton from the southern Atlantic and the southern Indian ocean. *Öfversigt af Kongliga Vetenskaps-Akademiens Förhandlingar 1900* 57:919–938.
- Cleve, P. T. 1904. Plankton table for the North Sea. Bulletin, Part D, May 1904. *Conseil Permanent pour l'Exploration de la Mer, Bulletin des Résultats aquis pendant les courses périodiques 1903–1904*:216.
- Cleve, P. T., & Grunow, A. 1880. Beiträge zur Kenntniss der arctischen Diatomeen. *Kongliga Svenska Vetenskaps-Akademiens Handlingar* 17(2):1–121.
- Cleve, P. T., & Möller, J. D. 1878. "Diatoms," Part 3, Nos. 109–168, pp. 1–9. Uppsala, Sweden.
- Cleve, P. T., & Möller, J. D. 1879. "Diatoms," Part 4, Nos. 169–216, pp. 1–7. Uppsala, Sweden.
- Cleve, P. T., & Möller, J. D. 1882. "Diatoms," Part 6, Nos. 277–324, pp. 1–6. Uppsala, Sweden.
- Cleve-Euler, A. 1912. Das Bacillariaceen-Plankton in Gewässern bei Stockholm III. Über Gemeinden des schwach salzigen Wassers und eine neue Charakterart derselben. *Archiv für Hydrobiologie und Planktonkunde* 7:500–514.
- Cleve-Euler, A. 1937. Undersökningar över Öresund. 24. Sundets plankton. 1. Sammansättning och fördelning. *Lunds Universitets Årsskrift N. F. Avdelning 2* 33(9):1–50.
- Cleve-Euler, A. 1952. Die Diatomeen von Schweden und Finnland. *Kungliga Svenska Vetenskapsakademiens Handlingar Fjärde Serien* 3(3):1–153.
- Cohen, A. L. 1974. Critical point drying. In "Principles and Techniques of Scanning Electron Microscopy 1" (A. M. Hyat, ed.), pp. 44–112. Van Nostrand-Reinhold, New York.
- Collier, A., & Murphy, A. 1962. Very small diatoms: Preliminary notes and description of *Chaetoceros galvestonensis*. *Science* 136:780–781.
- Comber, T. 1896. On the occurrence of endocysts in the genus *Thalassiosira*. *Journal of the Royal Microscopical Society* 9:489–491.
- Cooper, I. C. G. 1958. A new diatom from Fort Myers, Florida, U.S.A. *Revue Algologique* 2:125–128.
- Cox, E. J. 1979. Taxonomic studies on the diatom genus *Navicula* Bory: The typification of the genus. *Bacillaria* 2:137–153.
- Cox, E. J. 1981. The use of chloroplasts and other features of the living cell in the taxonomy of naviculoid diatoms. In "Proceedings of the 6th Symposium on Recent and Fossil Diatoms" (R. Ross, ed.), pp. 115–133. Koeltz, Koenigstein.
- Cox, E. J., & Ross, R. 1981. The striae of pennate diatoms. In "Proceedings of the 6th Symposium on Recent and Fossil Diatoms" (R. Ross, ed.), pp. 267–278. Koeltz, Koenigstein.
- Crawford, R. M. 1975. The taxonomy and classification of the diatom genus *Melosira* C. Ag. 1. The type species *M. nummuloides* C. Ag. *British Phycological Journal* 10:323–338.

- Crawford, R. M. 1979. Taxonomy and frustular structure of the marine centric diatom *Paralia sulcata*. *Journal of Phycology* 15:200–210.
- Crawford, R. M. 1988. A reconsideration of *Melosira arenaria* and *M. teres*; Resulting in a proposed new genus *Ellerbeckia*. In “Algae and the Aquatic Environment” (F. E. Round, ed.), pp. 413–433. Biopress, Bristol.
- Crawford, R. M., Gardner, C., & Medlin, L. K. 1994. The genus *Attheya*. I. A description of four taxa, and the transfer of *Gonioceros septentrionalis* and *G. armatus*. *Diatom Research* 9:27–51.
- Crawford, R. M., Sims, P. A., & Hajos, M. 1990. The morphology and taxonomy of the centric diatom genus *Paralia*. *Paralia siberica* comb. nov. *Diatom Research* 5:241–251.
- Cupp, E. E. 1943. Marine plankton diatoms of the west coast of North America. *Bulletin of the Scripps Institution of Oceanography of the University of California* 5:1–238.
- de Brébisson, A. 1857. Refermant la description de quelques nouvelles Diatomées dans le guano de Pérou, et formant le genre *Spatangidium*. *Bulletin de la Société Linnéenne de Normandie Caen Série 1* 2:292–298.
- de Brébisson, A., & Godey, A. 1838. “Consideration sur les diatomées et essai d’une classification des genre et des espèces appartenant à cette famille,” pp. 20, Brée L’Ainé, Falaise.
- Delgado, M., & Fortuño, J.-M. 1991. Atlas de fitoplancton del Mar Mediterráneo. *Scientia Marina* 55 (Suppl. 1):1–133.
- Desikachary, T. V. 1986–1989. “Atlas of diatoms 1–6,” 809 plates. Madras Science Foundation, Madras.
- Dickie, G. 1852. Notes on the algae. In “Journal of a Voyage in Baffin’s Bay and Barrow Straits in the Years 1850–1851 2.” (P. C. Sutherland, ed.) pp. cxc–cc. Longman, Brown, Green, and Longmans, London.
- Drebes, G. 1972. The life history of the centric diatom *Bacteriastrum hyalinum* Lauder. *Beiheft zur Nova Hedwigia* 39:95–110.
- Drebes, G. 1974. “Marines Phytoplankton. Eine Auswahl der Helgoländer Planktonalgen (Diatomeen, Peridineen),” pp. 186. Georg Thieme, Stuttgart.
- Drebes, G. 1977. Sexuality. *Blackwell Scientific Publications, Botanical Monographs* 13:250–283.
- Drum, R. W., & Pankratz, H. S. 1966. Locomotion and raphe structure of the diatom *Bacillaria*. *Nova Hedwigia* 10:315–317.
- Duke, E. L., Lewin, J., & Reimann, B. E. F. 1973. Light and electron microscope studies of diatom species belonging to the genus *Chaetoceros* Ehrenberg. I. *Chaetoceros septentrionale* Oestrup. *Phycologia* 12:1–9.
- Ehrenberg, C. G. 1838. “Die Infusionsthierchen als vollkommene Organismen.” pp. i–xvii, 548. Leopold Voss, Leipzig.
- Ehrenberg, C. G. 1839. Über die Bildung der Kreidefelsen und des Kreidemergels durch unsichtbare Organismen. *Abhandlungen der königlichen Akademie der Wissenschaften zu Berlin* 1838:59–147.
- Ehrenberg, C. G. 1841a. Über noch jetzt zahlreich lebende Thierarten der Kreidebildung und den Organismus der Polythalamien. *Abhandlungen der königlichen Akademie der Wissenschaften zu Berlin* 1839:81–174.
- Ehrenberg, C. G. 1841b. “Characteristic von 274 neuen Arten von Infusorien” (the article has no title.) *Deutsche Akademie der Wissenschaften zu Berlin* 1840:197–219.
- Ehrenberg, C. G. 1843. Verbreitung und Einfluss des mikroskopischen Lebens in Süd- und Nord-Amerika. *Abhandlungen der königlichen Akademie der Wissenschaften zu Berlin* 1841:291–445.
- Ehrenberg, C. G. 1844a. 2 neue Lager von Gebirgsmassen aus Infusorien als Meeres-Absatz in Nord-Amerika und eine Vergleichung derselben mit den organischen Kreide-Gebilden in

- Europa und Afrika. *Deutsche Akademie der Wissenschaften zu Berlin, Berichte Februar 1844*:57–97.
- Ehrenberg, C. G. 1844b. Einige vorläufige Resultate seiner Untersuchungen der ihm von der Südpolreise des Capitain Ross. *Deutsche Akademie der Wissenschaften zu Berlin, Berichte Mai 1844*:182–207.
- Ehrenberg, C. G. 1844c. Über das kleinste Leben in den Hochgebirgen von Armenien und Kurdistan. *Deutsche Akademie der Wissenschaften zu Berlin, Berichte Juni 1844*:252–275.
- Ehrenberg, C. G. 1845a. Novorum generum et specierum brevis definitio. *Deutsche Akademie der Wissenschaften zu Berlin, Berichte November 1845*:357–377.
- Ehrenberg, C. G. 1845b. Neue Untersuchungen über das kleinste Leben als geologisches Moment. Mit kurzer Charakteristik von 10 neuen Genera und 66 neuen Arten. *Deutsche Akademie der Wissenschaften zu Berlin, Berichte Februar 1845*:53–88.
- Ehrenberg, C. G. 1854. "Mikrogeologie," pp. 374 (atlas, pp. 88; 40 plates). Leopold Voss, Leipzig.
- Estep, K. W., Rey, F., Björklund, K., Dale, T., Heimdal, B. R., Van Hertum, A. J. W., Hill, D., Hodell, D., Syvertsen, E. E., Tangen, K., & Thronsdon, J. 1992. *Deus creavit; linneaus disposuit*: An international effort to create a catalogue and expert system for the identification of protistan species. *Sarsia* 77:275–285.
- Evensen, D. L., & Hasle, G. R. 1975. The morphology of some *Chaetoceros* (Bacillariophyceae) species as seen in the electron microscope. *Beiheft zur Nova Hedwigia* 53:153–174.
- Farr, E. R., Leussink, J. A., & Stafleu, F. A. 1979. Index Nominum Genericorum (Plantarum) 1–3 *Regnum vegetabile* 102:I–XXVI, 1–1896.
- Farr, E. R., Leussink, J. A., & Zijlstra, G. 1986. Index Nominum Genericorum (Plantarum) Supplementum I. *Regnum vegetabile* 113:VII–XIII, 1–126.
- Feibicke, M., Wendker, S., & Geissler, U. 1990. *Thalassiosira proschkinae* Makarova—A contribution to its morphology and autecology. *Beiheft zur Nova Hedwigia* 100:155–169.
- Ferrario, M. E. 1988. Ultrastructure de deux taxa de la famille Thalassiosiraceae. *Cryptogamie, Algologie* 9:311–318.
- Florin, M.-B. 1970. The fine structure of some pelagic fresh water diatom species under the scanning electron microscope. I. *Svensk Botanisk Tidskrift* 64:51–64.
- French, F. W., III, & Hargraves, P. E. 1985. Spore formation in the life cycles of the diatoms *Chaetoceros diadema* and *Leptocylindrus danicus*. *Journal of Phycology* 21:477–483.
- French, F. W., III, & Hargraves, P. E. 1986. Population dynamics of the spore-forming diatom *Leptocylindrus danicus* in Narragansett Bay, Rhode Island. *Journal of Phycology* 22:411–420.
- Frenguelli, J. 1939. Diatomeas del Golfo de San Matias. *Revista del Museo de La Plata* 2:201–226.
- Fryxell, G. A. 1975. Morphology, taxonomy, and distribution of selected diatom species of *Thalassiosira Cleve* in the Gulf of Mexico and Antarctic waters, pp. 189. Dissertation for the degree of Doctor of Philosophy, Texas A&M University. College Station, TX.
- Fryxell, G. A. 1976. The position of the labiate process in the diatom genus *Skeletonema*. *British Phycological Journal* 11:93–99.
- Fryxell, G. A. 1977. *Thalassiosira australis* Peragallo and *T. lentiginosa* (Janisch) G. Fryxell, comb.nov.: Two antarctic diatoms (Bacillariophyceae). *Phycologia* 16:95–104.
- Fryxell, G. A. 1978a. The diatom genus *Thalassiosira*: *T. licea* sp. nov. and *T. angstii* (Gran) Makarova, species with occluded processes. *Botanica Marina* 21:131–141.
- Fryxell, G. A. 1978b. Proposal for the conservation of the diatom *Coscinodiscus argus* Ehrenberg as the type of the genus. *Taxon* 27:122–125.
- Fryxell, G. A. 1978c. Chain-forming diatoms: Three species of Chaetoceraceae. *Journal of Phycology* 14:62–71.
- Fryxell, G. A. 1983. New evolutionary patterns in diatoms. *BioScience* 33:92–98.
- Fryxell, G. A. 1988. Polymorphism in relation to environmental conditions as exemplified by clonal cultures of *Thalassiosira tumida* (Janisch) Hasle. In "Proceedings of the 9th Interna-

- trional Diatom Symposium" (F. E. Round, ed.) pp. 61–73. Biopress, Bristol, and Koeltz Scientific Books, Koenigstein.
- Fryxell, G. A. 1989. Marine phytoplankton at the Weddell Sea ice edge: Seasonal changes at the specific level. *Polar Biology* 10:1–18.
- Fryxell, G. A. 1990. Family Hemidiscaceae: The genera *Actinocyclus* and *Azpeitia*. In "Polar Marine Diatoms" (L. K. Medlin & J. Priddle, eds.), pp. 111–113. British Antarctic Survey, Cambridge.
- Fryxell, G. A., & Ashworth, T. K. 1988. The diatom genus *Coscinodiscus* Ehrenberg: Characters having taxonomic value. *Botanica Marina* 31:359–374.
- Fryxell, G. A., & Hasle, G. R. 1971. *Corethron criophilum* Castracane: Its distribution and structure. *Antarctic Research Series 17, Biology of the Antarctic Seas* 4:335–346.
- Fryxell, G. A., & Hasle, G. R. 1972. *Thalassiosira eccentrica* (Ehrenb.) Cleve, *T. symmetrica* sp. nov., and some related centric diatoms. *Journal of Phycology* 8:297–317.
- Fryxell, G. A., & Hasle, G. R. 1977. The genus *Thalassiosira*: Some species with a modified ring of central strutted processes. *Beiheft zur Nova Hedwigia* 54:67–89.
- Fryxell, G. A., & Hasle, G. R. 1979a. The genus *Thalassiosira*: Species with internal extensions of the strutted processes. *Phycologia* 18:378–393.
- Fryxell, G. A., & Hasle, G. R. 1979b. The genus *Thalassiosira*: *T. trifulta* sp. nova and other species with tricolonnar supports on strutted processes. *Beiheft zur Nova Hedwigia* 64:13–32.
- Fryxell, G. A., & Hasle, G. R. 1980. The marine diatom *Thalassiosira oestrupii*: Structure, taxonomy and distribution. *American Journal of Botany* 67:804–814.
- Fryxell, G. A., & Hasle, G. R. 1983. The antarctic diatoms *Thalassiosira dichotomica* (Kozlova) comb.nov. and *T. ambigua* Kozlova. *Polar Biology* 2:53–62.
- Fryxell, G. A., & Johansen, J. R. 1990. Family Thalassiosiraceae. Section 2: The genus *Thalassiosira* from the Antarctic. In "Polar Marine Diatoms" (L. K. Medlin & J. Priddle, eds.) pp. 98–103. British Antarctic Survey, Cambridge.
- Fryxell, G. A., & Medlin, L. K. 1981. Chain forming diatoms: Evidence of parallel evolution in *Chaetoceros*. *Cryptogamie, Algologie* 2:3–29.
- Fryxell, G. A., & Miller, W. I., III 1978. Chain-forming diatoms: Three araphid species. *Bacillaria* 1:113–136.
- Fryxell, G. A., & Prasad, A. K. S. K. 1990. *Eucampia antarctica* var. *recta* (Mangin) stat.nov. (Biddulphiaceae, Bacillariophyceae): Life stages at the Weddell Sea ice edge. *Phycologia* 29:27–38.
- Fryxell, G. A., & Semina, H. J. 1981. *Actinocyclus exiguus* sp. nov. from the southern parts of the Indian and Atlantic Oceans. *British Phycological Journal* 16:441–448.
- Fryxell, G. A., Doucette, G. J., & Hubbard, G. F. 1981. The genus *Thalassiosira*: The bipolar diatom *T. antarctica* Comber. *Botanica Marina* 24:321–335.
- Fryxell, G. A., Gould, R. W., & Watkins, T. P. 1984. Gelatinous colonies of the diatom *Thalassiosira* in Gulf Stream warm core rings including *T. fragilis*, sp. nov. *British Phycological Journal* 19:141–156.
- Fryxell, G. A., Hasle, G. R., & Carty, S. V. 1986a. *Thalassiosira tumida* (Janisch) Hasle: Observations from field and clonal cultures. In "Proceedings of the 8th International Diatom Symposium" (M. Ricard, ed.), pp. 11–21. Koeltz, Koenigstein.
- Fryxell, G. A., Sims, P. A., & Watkins, T. P. 1986b. *Azpeitia* (Bacillariophyceae): Related genera and promorphology. *Systematic Botany Monographs* 13:1–74.
- Fryxell, G. A., Prasad, A. K. S. K., & Fryxell, P. A. 1989. *Eucampia antarctica* (Castracane) Mangin (Bacillariophyta): Complex nomenclature and taxonomic history. *Taxon* 38: 638–640.
- Fryxell, G. A., Reap, M. E., & Valencic, D. L. 1990. *Nitzschia pungens* Grunow f. *multiseries* Hasle: Observations of a known neurotoxic diatom. *Beiheft zur Nova Hedwigia* 100:171–188.
- Fryxell, G. A., Garza, S. A., & Roelke, D. L. 1991. Auxospore formation in an Antarctic clone of *Nitzschia subcurvata* Hasle. *Diatom Research* 6:235–245.

- Gaarder, K. R. 1951. Bacillariophyceae from the "Michael Sars" North Atlantic Deep-Sea Expedition 1910. *Report on the Scientific Results of the "Michael Sars" North Atlantic Deep-Sea Expedition 1910* 2(2):1–36.
- Gardner, C., & Crawford, R. M. 1994. A description of *Plagiogrammopsis mediaequatus* Gardner & Crawford, sp. nov. (Cymatosiraceae, Bacillariophyta) using light and electron microscopy. *Diatom Research* 9:53–63.
- Garrison, D. L., Conrad, S. M., Eilers, P. P., & Waldron, M. 1992. Confirmation of domoic acid production by *Pseudo-nitzschia australis* (Bacillariophyceae) cultures. *Journal of Phycology* 28:604–607.
- Gaul, U., Geissler, U., Henderson, M., Mahoney, R., & Reimer, C. W. 1993. Bibliography on the fine-structure of diatom frustules (Bacillariophyceae). *Proceedings of The Academy of Natural Sciences of Philadelphia* 144:69–238.
- Gersonde, R., & Harwood, D. M. 1990. Lower Cetaceous diatoms from ODP Leg 113 site 693 (Weddell Sea). 1. Vegetative cells. In "Proceedings of the Ocean Drilling Program, Scientific Results" (P. F. Baker, J. P. Kennett *et al.*, eds.), vol. 113, pp. 365–402. Ocean Drilling Program, College Station, TX.
- Glezer, Z. I. 1983. Taxonomical significance of characters in diatoms in the light of elaboration of a new Bacillariophyta classification. *Botanicheskii Zhurnal* 68:993–1002. [In Russian]
- Glezer, S. I., Makarova, I. V. (editor-in-chief), Moisseeva, A. I., & Nikolaev, V. A. 1988. "The Diatoms of the USSR, Fossil and Recent 2(1):Pyxidulaceae, Thalassiosiropsidaceae, Triceratidae, Thalassiosiraceae." In "NAUKA," pp. 116, 61 plates. Leningrad. [In Russian]
- Gmelin, J. F. 1791. "Systema Naturae," 13th Ed., 1(6):3021–3910. Georg Emanuel Beer, Leipzig.
- Gombos, A. M., Jr. 1980. The early history of the diatom family Asterolampraceae. *Bacillaria* 3:227–272.
- Gough, L. H. 1905. Report on the plankton of the English Channel in 1903. *North Sea Fisheries Investigations, Committee Report* 2:325–377.
- Gran, H. H. 1897a. Bacillariaceen vom kleinen Karajakfjord. *Bibliotheca Botanica* 8(42):13–24.
- Gran, H. H. 1897b. Protophyta: Diatomaceae, Silicoflagellata and Cilioflagellata. *The Norwegian North-Atlantic Expedition 1876–1878, Botany*, 1–36.
- Gran, H. H. 1900. Bemerkungen über einige Planktondiatomeen. *Nyt Magazin for Naturvidenskaberne* 38:103–128.
- Gran, H. H. 1904. Die Diatomeen der arktischen Meere. I. Die Diatomeen des Planktons. *Fauna Arctica* 3:509–554.
- Gran, H. H. 1908. Diatomeen. *Nordisches Plankton* 19:1–146.
- Gran, H. H. 1915. The plankton production of the North European waters in the spring of 1912. *Bulletin Planktonique pour l'année 1912*, 1–142.
- Gran, H. H., & Angst, E. C. 1931. Plankton diatoms of Puget Sound. *Publications Puget Sound Biological Station* 7:417–519.
- Gran, H. H., & Yendo, K. 1914. Japanese diatoms. I. On *Chaetoceras* II. On *Stephanopyxis*. *Videnskapsselskapets Skrifter I. Matematisk-Naturvidenskapelig Klasse* 8:3–29.
- Gregory, W. 1857. On new forms of marine Diatomaceae, found in the Firth of Clyde and in Loch Fine. *Transactions of the Royal Society of Edinburgh* 21:473–542.
- Greuter, W., Brummitt, R. K., Farr, E., Kilian, N., Kirk, P. M., & Silva, P. C. 1993. Names in current use for extant plant genera 3. *Regnum Vegetabile* 129:i–xxvii, 1–1464.
- Greville, W. 1859a. Descriptions of new species of British Diatomaceae, chiefly observed by the late Professor Gregory. *Quarterly Journal of Microscopical Science* 7:79–86.
- Greville, R. K. 1859b. Descriptions of diatomaceae observed in Californian guano. *Quarterly Journal of Microscopical Science* 7:155–166.
- Greville, R. K. 1860. A monograph of the genus *Asterolampra*, including *Asteromphalus* and *Spatangidium*. *Transactions of the Microscopical Society of London New Series* 8:102–125.
- Greville, R. K. 1862. Descriptions of new and rare diatoms. Series 5. *Transactions of the Microscopical Society of London New Series* 10:18–29.

- Greville, R. K. 1864. Descriptions of new species of diatoms from the South Pacific. *Transactions of the Botanical Society of Edinburgh* 8:233–238.
- Greville, R. K. 1865a. Descriptions of new and rare diatoms. Series 14. *Transactions of the Microscopical Society of London New Series* 13:1–10.
- Greville, R. K. 1865b. Descriptions of new genera and species from Hong Kong. *The Annals and Magazine of Natural History Series 3* 16(91):1–7.
- Greville, R. K. 1866. Descriptions of new and rare diatoms. Series 19. *Transactions of the Microscopical Society of London New Series* 14:77–86.
- Grunow, A. 1862. Die österreichischen Diatomaceen. *Verhandlungen der kaiserlich-königlichen zoologisch-botanischen Gesellschaft in Wien* 12:315–588.
- Grunow, A. 1863. Ueber einige neue und ungenügend bekannte Arten und Gattungen von Diatomaceen. *Verhandlungen der kaiserlich-königlichen zoologisch-botanischen Gesellschaft in Wien* 13:137–162.
- Grunow, A. 1867. Diatomeen auf *Sargassum* von Honduras, gesammelt von Lindig. *Hedwigia* 6:1–8, 17–37.
- Grunow, A. 1868. Algen. *Reise seiner Majestät Fregatte Novaria um die Erde Botanischer Theil* 1:1–104.
- Grunow, A. 1877. I. New diatoms from Honduras. *Transactions of the Royal Microscopical Society* 18:165–186.
- Grunow, A. 1878. Algen und Diatomaceen aus dem Kaspischen Meere. In “O. Schneider: Naturwissenschaftliche Beiträge zur Kenntniss der Kaukasusländer,” pp. 98–160.
- Grunow, A. 1879. New species and varieties of Diatomaceæ from the Caspian Sea. Translated with additional notes by F. Kitton. *Journal of the Royal Microscopical Society* 2:677–691.
- Grunow, A. 1884. Die Diatomeen von Franz Josefs-Land. *Denkschriften der kaiserlichen Akademie der Wissenschaften. Mathematisch-naturwissenschaftliche Classe. Wien* 28:53–112.
- Guiffré, G., & Ragusa, S. 1988. The morphology of *Chaetoceros rostratum* Lauder (Bacillariophyceae) using light and electron microscopy. *Botanica Marina* 31:503–510.
- Guillard, R. R. L., & Ryther, J. H. 1962. Studies of marine planktonic diatoms I. *Cyclotella nana* Hustedt, and *Detonula confervacea* (Cleve) Gran. *Canadian Journal of Microbiology* 8:229–239.
- Guillard, R. R. L., Carpenter, E. J., & Reimann, E. F. 1974. *Skeletonema menzelii* sp. nov., a new diatom from the western Atlantic Ocean. *Phycologia* 13:131–138.
- Guo, Yujie (Kuo Yuchieh) 1981. Studies on the planktonic *Coscinodiscus* (diatoms) of the South China Sea. *Studia Marina Sinica* 18:149–180.
- Gutenbrunner, S. A., Thalhamer, J., & Schmid, A-M. M. 1994. Proteinaceous and immunochemical distinctions between the *oval* and *fusiform* morphotypes of *Phaeodactylum tricoratum* (Bacillariophyceae). *Journal of Phycology* 30:129–136.
- Håkansson, H. 1989. A light and electron microscopical investigation of the type species of *Cyclotella* (Bacillariophyceae) and related forms, using original material. *Diatom Research* 4:255–267.
- Håkansson, H., & Ross, R. 1984. Proposals to designate conserved types for *Cymbella* C. Agardh and *Cyclotella* (Kützinger) Brébisson, and to conserve *Rhopalodia* O. Müller against *Pyxidicula* Ehrenberg (all Bacillariophyceae). *Taxon* 33:525–531.
- Hallegraeff, G. M. 1984. Species of the diatom genus *Thalassiosira* in Australian waters. *Botanica Marina* 27:495–513.
- Hallegraeff, G. M. 1986. Taxonomy and morphology of the marine planktonic diatoms *Thalassionema* and *Thalassiothrix*. *Diatom Research* 1:57–80.
- Hallegraeff, G. M. 1992. Observations on the mucilaginous diatom *Thalassiosira bipartita* (Rat-tray) comb.nov. from the tropical Indo-west Pacific. *Diatom Research* 7:15–23.
- Hargraves, P. E. 1976. Studies on marine plankton diatoms. III. Structure and classification of *Gossleriella tropica*. *Journal of Phycology* 12:285–291.

- Hargraves, P. E. 1979. Studies on marine plankton diatoms IV. Morphology of *Chaetoceros* resting spores. *Beiheft zur Nova Hedwigia* 64:99–120.
- Hargraves, P. E. 1982. Resting spore formation in the marine diatom *Ditylum brightwellii* (West) Grun. ex V. H. In "Proceedings of the Seventh International Diatom Symposium" (D. G. Mann, ed.), pp. 33–46.
- Hargraves, P. E. 1990. Studies on marine planktonic diatoms. V. Morphology and distribution of *Leptocylindrus minimus* Gran. *Beiheft zur Nova Hedwigia* 100:47–60.
- Hargraves, P. E., & French, F. W. 1983. Diatom resting spores: Significance and strategies. In "Survival Strategies of the Algae" (G. A. Fryxell, ed.), pp. 49–68. Cambridge University Press, Cambridge.
- Hargraves, P. E., & Guillard, R. R. L. 1974. Structural and physiological observations on some small marine diatoms. *Phycologia* 13:163–172.
- Hasle, G. R. 1960. Phytoplankton and ciliate species from the tropical Pacific. *Skrifter utgitt av Det Norske Videnskaps-Akademi i Oslo I. Matematisk-Naturvidenskapelig Klasse* 2:1–50.
- Hasle, G. R. 1964. *Nitzschia* and *Fragilariopsis* species studied in the light and electron microscopes. I. Some marine species of the groups *Nitzschiella* and *Lanceolatae*. *Skrifter utgitt av Det Norske Videnskaps-Akademi i Oslo. I. Matematisk-Naturvidenskapelig Klasse. Ny Serie* 16:1–48.
- Hasle, G. R. 1965a. *Nitzschia* and *Fragilariopsis* species studied in the light and electron microscopes. III. The genus *Fragilariopsis*. *Skrifter utgitt av Det Norske Videnskaps-Akademi i Oslo. I. Matematisk-Naturvidenskapelig Klasse. Ny Serie* 21:1–49.
- Hasle, G. R. 1965b. *Nitzschia* and *Fragilariopsis* species studied in the light and electron microscopes. II. The group *Pseudo-nitzschia*. *Skrifter utgitt av Det Norske Videnskaps-Akademi i Oslo. I. Matematisk-Naturvidenskapelig Klasse. Ny Serie* 18:1–45.
- Hasle, G. R. 1968a. The valve processes of the centric diatom genus *Thalassiosira*. *Nytt Magazin for Botanikk* 15:193–201.
- Hasle, G. R. 1968b. Marine diatoms. *Antarctic Map Folio Series* 10:6–8.
- Hasle, G. R. 1968c. Observations on the marine diatom *Fragilariopsis kerguelensis* (O'Meara) Hust. in the scanning electron microscope. *Nytt Magazin for Botanikk* 15:205–208.
- Hasle, G. R. 1969. An analysis of the phytoplankton of the Pacific Southern Ocean: Abundance, composition, and distribution during the Brategg Expedition, 1947–1948. *Hvalrådet's Skrifter* 52:1–168.
- Hasle, G. R. 1971. *Nitzschia pungiformis* (Bacillariophyceae), a new species of the *Nitzschia seriata* group. *Norwegian Journal of Botany* 18:139–144.
- Hasle, G. R. 1972a. *Thalassiosira subtilis* (Bacillariophyceae) and two allied species. *Norwegian Journal of Botany* 19:111–137.
- Hasle, G. R. 1972b. The inclusion of *Coscosira* Gran (Bacillariophyceae) in *Thalassiosira* Cleve. *Taxon* 21:543–544.
- Hasle, G. R. 1972c. *Fragilariopsis* as a section of the genus *Nitzschia* Hassall. *Beiheft zur Nova Hedwigia* 39:111–119.
- Hasle, G. R. 1972d. The distribution of *Nitzschia seriata* Cleve and allied species. *Beiheft zur Nova Hedwigia* 39:171–190.
- Hasle, G. R. 1973a. Some marine plankton genera of the diatom family Thalassiosiraceae. *Beiheft zur Nova Hedwigia* 45:1–49.
- Hasle, G. R. 1973b. Morphology and taxonomy of *Skeletonema costatum* (Bacillariophyceae). *Norwegian Journal of Botany* 20:109–137.
- Hasle, G. R. 1973c. The "mucilage pore" of pennate diatoms. *Beiheft zur Nova Hedwigia* 45:167–186.
- Hasle, G. R. 1974. Validation of the names of some marine planktonic species of *Nitzschia* (Bacillariophyceae). *Taxon* 23:425–428.
- Hasle, G. R. 1975. Some living marine species of the diatom family Rhizosoleniaceae. *Beiheft zur Nova Hedwigia* 53:99–140.

- Hasle, G. R. 1976a. The biogeography of some marine planktonic diatoms. *Deep-Sea Research* 23:319–338.
- Hasle, G. R. 1976b. Examination of diatom type material: *Nitzschia delicatissima* Cleve, *Thalassiosira minuscula* Krasske, and *Cyclotella nana* Hustedt. *British Phycological Journal* 11:101–110.
- Hasle, G. R. 1977. Morphology and taxonomy of *Actinocyclus normanii* f. *subsalsa* (Bacillariophyceae). *Phycologia* 16:321–328.
- Hasle, G. R. 1978a. Some *Thalassiosira* species with one central process. *Norwegian Journal of Botany* 25:77–110.
- Hasle, G. R. 1978b. Some freshwater and brackish water species of the diatom genus *Thalassiosira* Cleve. *Phycologia* 17:263–292.
- Hasle, G. R. 1979. *Thalassiosira decipiens* (Grun.) Jørg. (Bacillariophyceae). *Bacillaria* 2:85–108.
- Hasle, G. R. 1980. Examination of *Thalassiosira* type material: *T. minima* and *T. delicatula* (Bacillariophyceae). *Norwegian Journal of Botany* 27:167–173.
- Hasle, G. R. 1983a. The marine planktonic diatoms *Thalassiosira oceanica* sp. nov. and *T. partheneia*. *Journal of Phycology* 19:220–229.
- Hasle, G. R. 1983b. *Thalassiosira punctigera* (Castr.) comb. nov., a widely distributed marine planktonic diatom. *Nordic Journal of Botany* 3:593–608.
- Hasle, G. R. 1983c. Proposal to conserve the generic name *Cerataulina* H. Perag. ex Schütt over *Syringidium* Ehrenb. *Taxon* 32:474–475.
- Hasle, G. R. 1990. The planktonic marine diatom *Thalassiosira mediterranea* (synonym *Thalassiosira stellaris*). *Diatom Research* 5:415–418.
- Hasle, G. R. 1993. Nomenclatural notes on marine planktonic diatoms. The family Bacillariaceae. *Beiheft zur Nova Hedwigia* 106:315–321.
- Hasle, G. R. 1994. *Pseudo-nitzschia* as a genus distinct from *Nitzschia* (Bacillariophyceae). *Journal of Phycology* 30:1036–1039.
- Hasle, G. R. 1995. *Pseudo-nitzschia pungens* and *P. multiseriis* (Bacillariophyceae): Nomenclatural history, morphology and distribution. *Journal of Phycology* 31(3):428–435.
- Hasle, G. R., & Booth, B. C. 1984. *Nitzschia cylindroformis* sp. nov., a common and abundant nanoplankton diatom of the eastern subarctic Pacific. *Journal of Plankton Research* 6:493–503.
- Hasle, G. R., & Evensen, D. L. 1975. Brackish-water and fresh-water species of the diatom genus *Skeletonema* Grev. I. *Skeletonema subsalsum* (A. Cleve) Bethge. *Phycologia* 14:283–297.
- Hasle, G. R., & Fryxell, G. A. 1977a. *Thalassiosira conferta* and *T. binata*, two new diatom species. *Norwegian Journal of Botany* 24:239–248.
- Hasle, G. R., & Fryxell, G. A. 1977b. The genus *Thalassiosira*: Some species with a linear areola array. *Beiheft zur Nova Hedwigia* 54:15–66.
- Hasle, G. R. & Fryxell, G. A. (1995). Taxonomy. Diatoms. *Unesco Monographs on Oceanographic Methodology*, in press.
- Hasle, G. R., & Heimdal, B. R. 1968. Morphology and distribution of the marine centric diatom *Thalassiosira antarctica* Comber. *Journal of the Royal Microscopical Society* 88:357–369.
- Hasle, G. R., & Heimdal, B. R. 1970. Some species of the centric diatom genus *Thalassiosira* studied in the light and electron microscopes. *Beiheft zur Nova Hedwigia* 31:543–581.
- Hasle, G. R., & Lange, C. B. 1989. Freshwater and brackish water *Thalassiosira* (Bacillariophyceae): Taxa with tangentially undulated valves. *Phycologia* 28:120–135.
- Hasle, G. R., & Lange, C. B. 1992. Morphology and distribution of *Coscinodiscus* species from the Oslofjord, Norway, and the Skagerrak, North Atlantic. *Diatom Research* 7:37–68.
- Hasle, G. R., & Medlin, L. K. 1990a. Family Bacillariaceae: The genus *Nitzschia* section *Nitzschia*. In “Polar Diatoms” (L. K. Medlin & J. Priddle, eds.), pp. 177–180. British Antarctic Survey, Cambridge.
- Hasle, G. R., & Medlin, L. K. 1990b. Family Bacillariaceae: The genus *Nitzschia* section *Fragilariopsis*. In “Polar Diatoms” (L. K. Medlin & J. Priddle, eds.), pp. 181–196. British Antarctic Survey, Cambridge.



- Hasle, G. R., & Medlin, L. K. 1990c. Family Bacillariaceae: The genus *Nitzschia* section *Pseudo-nitzschia*. In "Polar Diatoms" (L. K. Medlin & J. Priddle, eds.), pp. 169–176. British Antarctic Survey, Cambridge.
- Hasle, G. R., & de Mendiola, B. R. E. 1967. The fine structure of some *Thalassionema* and *Thalassiothrix* species. *Phycologia* 6:107–125.
- Hasle, G. R., & Semina, H. J. 1988. The marine planktonic diatoms *Thalassiothrix longissima* and *Thalassiothrix antarctica* with comments on *Thalassionema* spp. and *Synedra reinboldii*. *Diatom Research* 2:175–192.
- Hasle, G. R., & Sims, P. A. 1985. The morphology of the diatom resting spores *Syringidium bicorne* and *Syringidium simplex*. *British Phycological Journal* 20:219–225.
- Hasle, G. R., & Sims, P. A. 1986a. The diatom genus *Coscinodiscus* Ehrenb.: *C. argus* Ehrenb. and *C. radiatus* Ehrenb. *Botanica Marina* 29:305–318.
- Hasle, G. R., & Sims, P. A. 1986b. The diatom genera *Stellarima* and *Symbolophora* with comments on the genus *Actinoptychus*. *British Phycological Journal* 21:97–114.
- Hasle, G. R., & Syvertsen, E. E. 1980. The diatom genus *Cerataulina*: Morphology and taxonomy. *Bacillaria* 3:79–113.
- Hasle, G. R., & Syvertsen, E. E. 1981. The marine diatoms *Fragilaria striatula* and *F. hyalina*. *Striae* 14:110–118.
- Hasle, G. R., & Syvertsen, E. E. 1984. *Coscinodiscus pseudolineatus* Pant. and *Coscinodiscus praelineatus* Jousé as synonyms of *Thalassiosira leptopus* (Grun.) Hasle & G. Fryxell. In "Proceedings of the 7th International Diatom Symposium" (D. G. Mann, ed.), pp. 145–155. Koeltz, Koenigstein.
- Hasle, G. R., & Syvertsen, E. E. 1990a. Family Thalassiosiraceae. Section 1: The genera *Skeletonema*, *Porosira*, *Bacterosira*, and *Detonula* and the genus *Thalassiosira* from the Arctic. In "Polar Marine Diatoms" (L. K. Medlin & J. Priddle, eds.), pp. 83–89. British Antarctic Survey, Cambridge.
- Hasle, G. R., & Syvertsen, E. E. 1990b. Arctic diatoms in the Oslofjord and the Baltic Sea, a bio- and palaeographic problem? In "Proceedings of the 10th International Diatom Symposium" (H. Simola, ed.), pp. 285–300. Koeltz, Koenigstein.
- Hasle, G. R., & Syvertsen, E. E. 1990c. Family Coscinodiscaceae: The genus *Stellarima*. In "Polar Marine Diatoms" (L. K. Medlin & J. Priddle, eds.), p. 109. British Antarctic Survey, Cambridge.
- Hasle, G. R., & Syvertsen, E. E. 1993. New nomenclatural combinations of marine diatoms. The families Thalassiosiraceae and Rhabdioneidaceae. *Beiheft zur Nova Hedwigia* 106:297–314.
- Hasle, G. R., Heimdal, B. R., & Fryxell, G. A. 1971. Morphologic variability in fasciculated diatoms as exemplified by *Thalassiosira tumida* (Janisch) Hasle, comb. nov. *Biology of the Antarctic Seas* 4, *Antarctic Research Series* 17:313–333.
- Hasle, G. R., von Stosch, H. A., & Syvertsen, E. E. 1983. Cymatosiraceae, a new diatom family. *Bacillaria* 6:9–156.
- Hasle, G. R., Sims, P. A., & Syvertsen, E. E. 1988. Two Recent *Stellarima* species: *S. microtrias* and *S. stellaris* (Bacillariophyceae). *Botanica Marina* 31:195–206.
- Hasle, G. R., Medlin, L. K., & Syvertsen, E. E. 1994. *Synedropsis* gen. nov., a genus of araphid diatoms associated with sea ice. *Phycologia* 33:248–270.
- Hasle, G. R., Lange, C. B., & Syvertsen, E. E. 1995. A review of *Pseudo-nitzschia*, with special reference to the Skagerrak, North Atlantic, and adjacent waters. *Helgoländer Meeresuntersuchungen*, 50, (in press).
- Heiden, H., & Kolbe, R. W. 1928. Die marinen Diatomeen der Deutschen Südpolar-Expedition 1901–3. *Deutsche Südpolar-Expedition 1901–1903* 8:447–715.
- Heimdal, B. R. 1970. Morphology and distribution of two *Navicula* species in Norwegian coastal waters. *Nytt Magazin for Botanikk* 17:65–75.
- Heimdal, B. R. 1971. Vegetative cells and resting spores of *Thalassiosira constricta* Gaarder (Bacillariophyceae). *Norwegian Journal of Botany* 18:153–159.

- Heimdal, B. R. 1983. Phytoplankton and nutrients in the waters north-west of Spitsbergen in the autumn of 1979. *Journal of Plankton Research* 5:901–918.
- Helmcke, J.-G., & Krieger, W. 1953. "Diatomeenschalen im elektronenmikroskopischen Bild 1," pp. 19, plates 1–102. Cramer, Weinheim.
- Helmcke, J.-G., & Krieger, W. 1954. "Diatomeenschalen im elektronenmikroskopischen Bild 2," pp. 24, plates 103–200. Cramer, Weinheim.
- Hendey, N. I. 1937. The plankton diatoms of the Southern Seas. *Discovery Reports* 16:151–364.
- Hendey, N. I. 1951. Littoral diatoms of Chichester harbour with special reference to fouling. *Journal of the Royal Microscopical Society* 71:1–86.
- Hendey, N. I. 1954. Note on the Plymouth "Nitzschia" culture. *Journal of the Marine Biological Association of the United Kingdom* 33:335–339.
- Hendey, N. I. 1964. An introductory account of the smaller algae of British coastal waters. Part 5: Bacillariophyceae (Diatoms). In "Ministry of Agriculture, Fisheries and Food. Fishery Investigations Series IV," pp. 317. HMSO, London.
- Hensen, V. 1887. Ueber die Bestimmung der Plankton's oder des im Meere treibenden Materials an Pflanzen und Thieren. *Bericht der Commission zur wissenschaftlichen Untersuchung der deutschen Meere, in Kiel* 5:1–107.
- Hernández-Becerril, D. U. 1990. Observations on the morphology and distribution of the planktonic diatom *Neodelphineis pelagica*. *British Phycological Journal* 25:315–319.
- Hernández-Becerril, D. U. 1991a. The morphology and taxonomy of species of the diatom genus *Asteromphalus* Ehr. *Bibliotheca Diatomologica* 23:1–55, 33 plates.
- Hernández-Becerril, D. U. 1991b. The morphology and taxonomy of the planktonic diatom *Chaetoceros coarctatus* Lauder (Bacillariophyceae). *Diatom Research* 6:281–287.
- Hernández-Becerril, D. U. 1991c. Note on the morphology of *Chaetoceros didymus* and *C. protuberans*, with some considerations on their taxonomy. *Diatom Research* 6:289–297.
- Hernández-Becerril, D. U. 1992a. Reinstatement of the diatom genus *Spatangidium* (Bacillariophyta): The type species *S. arachne*. *Phycologia* 31:278–284.
- Hernández-Becerril, D. U. 1992b. Two new species of the diatom genus *Chaetoceros* (Bacillariophyta). *Plant Systematics and Evolution* 181:217–226.
- Hernández-Becerril, D. U. 1992c. Observations on two closely related species, *Chaetoceros tetrastichon* and *C. dadayi* (Bacillariophyceae). *Nordic Journal of Botany* 12:365–371.
- Hernández-Becerril, D. U. 1993a. Note on the morphology of two planktonic diatoms: *Chaetoceros bacteriastroides* and *C. seychellarus*, with comments on their taxonomy and distribution. *Botanical Journal of the Linnean Society* 111:117–128.
- Hernández-Becerril, D. U. 1993b. Study of the morphology and distribution of two planktonic diatoms: *Chaetoceros paradoxus* and *Ch. filiferus* (Bacillariophyceae). *Cryptogamic Botany* 3:169–175.
- Hernández-Becerril, D. U., Castillo, M. E. del, & Villa, M. A. L. 1993. Observations on *Chaetoceros buceros* (Bacillariophyceae), a rare tropical planktonic species collected from the Mexican Pacific. *Journal of Phycology* 29:811–818.
- Herzig, W. N., & Fryxell, G. A. 1986. The diatom genus *Thalassiosira* Cleve in the Gulf Stream core rings: Taxonomy, with *T. intrannula* and *T. lineoides*, spp. nov. *Botanica Marina* 29:11–25.
- Hoban, M. A. 1983. Biddulphoid diatoms. II: The morphology and systematics of the pseudocellate species, *Biddulphia biddulphiana* (Smith) Boyer, *B. alternans* (Bailey) Van Heurck, and *Trigonium arcticum* (Brightwell) Cleve. *Botanica Marina* 26:271–284.
- Hoban, M. A., Fryxell, G. A., & Buck, K. R. 1980. Biddulphoid diatoms: Resting spores in Antarctic *Eucampia* and *Odontella*. *Journal of Phycology* 16:591–602.
- Holmes, R. W. 1956. The annual cycle of phytoplankton in the Labrador Sea, 1950–51. *Bulletin of the Bingham Oceanographic Collection* 16(1):1–74.
- Hustedt, F. 1926. *Thalassiosira fluviatilis* nov. spec., eine Wasserblüte im Wesergebiet. *Berichte der deutschen botanischen Gesellschaft* 43:565–567.

- Hustedt, F. 1930. Die Kieselalgen Deutschlands, Österreichs und der Schweiz. *Dr. L. Rabenhorsts Kryptogamen-Flora von Deutschland, Österreich und der Schweiz* 7(1):1–920.
- Hustedt, F. 1939. Die Diatomeenflora des Küstengebietes der Nordsee vom Dollart bis zur Elbemündung. *Abhandlungen herausgegeben vom Naturwissenschaftlichen Verein zu Bremen* 31:571–677.
- Hustedt, F. 1952. Diatomeen aus der Lebensgemeinschaft des Buckelwals (*Megaptera nodosa* Bonn.). *Archiv für Hydrobiologie* 46:286–298.
- Hustedt, F. 1955. Marine littoral diatoms of Beaufort, North Carolina. *Bulletin Duke University Marine Station* 6:1–67.
- Hustedt, F. 1956. Diatomeen aus dem Lago de Maracaibo in Venezuela. *Ergebnisse der deutschen limnologischen Venezuela-Expedition 1952* 1:93–140.
- Hustedt, F. 1957. Die Diatomeenflora des Flusssystemes der Weser im Gebiet der Hansestadt Bremen. *Abhandlungen herausgegeben vom Naturwissenschaftlichen Verein zu Bremen* 34:181–440.
- Hustedt, F. 1958a. Diatomeen aus der Antarktis und dem Südatlantik. *Deutsche antarktische Expedition 1938/39* 2:103–191.
- Hustedt, F. 1958b. Phylogenetische Untersuchungen an Diatomeen. *Österreichische botanische Zeitschrift* 105:193–211.
- Hustedt, F. 1959. Die Kieselalgen Deutschlands, Österreichs und der Schweiz. *Dr. L. Rabenhorsts Kryptogamen-Flora von Deutschland, Österreich und der Schweiz* 7(2):1–845.
- Hustedt, F. 1961. Die Kieselalgen Deutschlands, Österreichs und der Schweiz. *Dr. L. Rabenhorsts Kryptogamen-Flora von Deutschland, Österreich und der Schweiz* 7(3):1–816.
- Ikari, J. 1927. On *Bacteriastrium* of Japan. *The Botanical Magazine, Tokyo* 41:421–431.
- Johansen, J. R., & Fryxell, G. A. 1985. The genus *Thalassiosira* (Bacillariophyceae): Studies on species occurring south of the Antarctic Convergence Zone. *Phycologia* 24:155–179.
- Jørgensen, E. 1899. Protophyten und Protozoen im Plankton aus der norwegischen Westküste. *Bergens Museums Aarvog for 1899* 6:1–112, LXXXIII.
- Jørgensen, E. 1905. Protist plankton of Northern Norwegian fiords. *Bergens Museums Skrifter* 1905:49–151.
- Jordan, R. W., Ligowski, R., Nöthig, E.-M., & Priddle, J. 1991. The diatom genus *Proboscia* in Antarctic waters. *Diatom Research* 6:63–78.
- José, A. P. 1968. Species novae Bacillariophytorum in sedimentis fundi Oceani Pacifici et Maris Ochotensis inventae. *Novitates Systematicae Plantarum non Vascularium* 1968:12–21.
- José, A. P., Koroleva, G. S., & Nagaeva, G. A. 1962. Diatoms in the surface layer of sediment in the Indian sector of the Antarctic. *Trudy IOAN* 61:19–92 [In Russian, title and abstract in English]
- Juhlin-Dannfelt, H. 1882. On the diatoms of the Baltic Sea. *Bihang till Kongliga Svenska Vetenskaps-Akademiens Handlingar* 6(21):1–52.
- Kaczmarek, I., & Fryxell, G. A. 1986. The diatom genus *Nitzschia*: Morphologic variation of some small bicapitate species in two Gulf Stream warm core rings. In “Proceedings of the 8th International Diatom Symposium” (M. Ricard, ed.), pp. 237–255. Koeltz, Koenigstein.
- Kaczmarek, I., & Fryxell, G. A. 1994. The genus *Nitzschia*: Three new species from the Equatorial Pacific Ocean. *Diatom Research* 9:87–98.
- Kaczmarek, I., Fryxell, G. A., & Watkins, T. P. 1986. Effect of two Gulf Stream warm-core rings on distributional patterns of the diatom genus *Nitzschia*. *Deep-Sea Research* 33:1843–1868.
- Karayeva, N. I., & Dzharfaroova, S. K. 1984. On the morphology of *Coscinodiscus granii* (Bacillariophyta). *Botanicheskii Zhurnal* 70:1078–1082. [In Russian]
- Karsten, G. 1905. Das Phytoplankton des Antarktischen Meeres nach dem Material der deutschen Tiefsee-Expedition 1898–1899. *Deutsche Tiefsee-Expedition 1898–1899* 2(2):1–136.
- Karsten, G. 1907. Das indische Phytoplankton. Nach dem Material der Deutschen Tiefsee-Expedition 1889–1899. *Deutsche Tiefsee-Expedition 1889–1899* 2(2):221–538.

- Koch, P., & Rivera, P. 1984. Contribucion al conocimiento de las diatomeas Chilenas III el genero *Chaetoceros* Ehr (subgenero *Phaeoceros* Gran). *Gayana, Botanica* 41:61–84.
- Kolbe, R. W. 1954. Diatoms from equatorial Pacific cores. *Reports of the Swedish Deep-Sea Expedition* 6(1):1–49.
- Kolbe, R. W. 1955. Diatoms from equatorial Atlantic cores. *Reports of the Swedish Deep-Sea Expedition* 7(3):150–184.
- Kolbe, R. W. 1957. Diatoms from equatorial Indian Ocean cores. *Reports of the Swedish Deep-Sea Expedition* 9(1):1–50.
- Körner, H. 1970. Morphologie und Taxonomie der Diatomeengattung *Asterionella*. *Nova Hedwigia* 20:557–724.
- Kozlova, O. G. 1967. De speciebus Bacillariophytorum novis e partibus Antarcticis Oceanorum Indici et Pacifici. *Novitates Systematicae Plantarum non Vascularium* 1967:54–62.
- Krasske, G. 1941. Die Kieselalgen des chilenischen Küstenplanktons. *Archiv für Hydrobiologie* 38:260–287.
- Kützing, F. T. 1844. “Die kieselschaligen Bacillarien oder Diatomeen,” pp. 152. Ferd. Förstmann, Nordhausen, 1865, Zweiter Abdruck.
- Kützing, F. T. 1849. “Species Algarum,” pp. 922. Leipzig.
- Lange, C. B. 1985. Spatial and seasonal variations of diatom assemblages off the Argentinian coast (South Western Atlantic). *Oceanologica Acta* 8:361–369.
- Lange, C. B., & Mostajo, E. L. 1985. Phytoplankton (diatoms and silicoflagellates) from the southwestern Atlantic Ocean. *Botanica Marina* 28:469–476.
- Lange, C. B., & Syvertsen, E. E. 1989. *Cyclotella litoralis* sp. nov. (Bacillariophyceae), and its relationship to *C. striata* and *C. stylorum*. *Nova Hedwigia* 48:341–356.
- Lange, C. B., Hasle, G. R., & Syvertsen, E. E. 1992. Seasonal cycle of diatoms in the Skagerrak, North Atlantic, with emphasis on the period 1980–1990. *Sarsia* 77:173–187.
- Lauder, H. S. 1864a. On new diatoms. *Transactions of the Microscopical Society of London New Series* 12:6–8.
- Lauder, H. S. 1864b. Remarks on the marine diatomaceæ found at Hong Kong, with descriptions of new species. *Transactions of the Microscopical Society of London New Series* 12:75–79.
- Lebour, M. V. 1930. “The Planktonic Diatoms of Northern Seas,” pp. 244. Ray Society, London.
- Lee, J. H., & Lee, J. Y. 1990. A light and electron microscopy study on the marine diatom *Roperia tessellata* (Roper) Grunow. *Diatom Research* 5:325–335.
- Levander, K. M. 1904. Zur Kenntnis der Rhizosolenien Finlands. *Meddelanden af Societas pro Fauna et Flora Fennica* 30:112–117.
- Lewin, J. C. 1958. The taxonomic position of *Phaeodactylum tricorutum*. *The Journal of General Microbiology* 18:427–432.
- Lewin, J. C., & Norris, R. E. 1970. Surf-zone diatoms of the coasts of Washington and New Zealand (*Chaetoceros armatum* T. West and *Asterionella* spp.). *Phycologia* 9:143–149.
- Loeblich, A. R., III, Wight, W. W., & Darley, W. M. 1968. A unique colonial marine centric diatom *Coenobiodiscus muriformis* gen. et sp. nov. *Journal of Phycology* 4:23–29.
- Lønne, O. J. 1988. A diver operated electric suction sampler for sympagic (= under ice) invertebrates. *Polar Research* 6:135–136.
- Lundholm, N., Skov, J., Pocklington, R., & Moestrup, Ø. 1994. Domoic acid, the toxic amino acid responsible for amnesic shellfish poisoning, now in *Pseudo-nitzschia seriata* (Bacillariophyceae) in Europe (Research Note). *Phycologia* 33:475–478.
- Lyngbye, H. C. 1819. “Tentamen Hydrophytologiae Danicae,” pp. 248. Gyldendal, Copenhagen.
- Makarova, I. V. 1970. Ad taxonomiam specierum nonnullarum generis *Thalassiosira* Cl. *Novitates Systematicae Plantarum non Vascularium* 7:13–20.
- Makarova, I. V. 1977. Proposals for a standardization of diatom terminology and diagnosis. *Botanicheskii Zhurnal* 62:192–213. [in Russian]
- Makarova, I. V. 1985. On the morphology and taxonomy of two species of the genus *Coscinodiscus* (Bacillariophyta). *Botanicheskii Zhurnal* 70:51–54. [in Russian]

- Makarova, I. V. 1988. "Diatomovoye vodorosli morei SSSR: Rod Thalassiosira Cl," pp. 115. Akademiya NAUK SSSR, Leningrad.
- Makarova, I. V., Genkal, S. I., & Kuzmin, G. V. 1979. Species of the genus *Thalassiosira* Cl. (Bacillariophyta), found in continental waterbodies of the U.S.S. R. *Botanicheskii Zhurnal* 64:921–927. [In Russian, title and abstract in English]
- Mangin, L. 1910. Sur quelques algues nouvelles ou peu connues du phytoplancton de l'Atlantique. *Bulletin de la Société Botanique de France* 57:344–383.
- Mangin, L. 1915. Phytoplancton de l'Antarctique. Expédition du "Pourquoi-Pas?" 1908–1910. *Deuxième Expédition Antarctique Française 1908–1910, Sciences naturelles: Documents scientifiques*, 1–96.
- Mangin, L. 1917. Sur le *Chaetoceros criophilus* Castr., espèce caractéristique des mers antarctique. *Comptes rendus des séances de l'Académie des Sciences* 164:1–9.
- Mangin, L. 1922. Phytoplancton antarctique. Expédition antarctique de la "Scotia" 1902–1904. *Memoires de l'Académie Sciences. Paris, Série 2* 57(2):1–134.
- Manguin, E. 1957. Premier inventaire des diatomées de la Terre Adélie antarctique. Espèces nouvelles. *Revue Algologique, Serie 2* 3:111–134.
- Manguin, E. 1960. Les diatomées de la Terre Adélie. Campagne du "Commandant Charcot" 1949–1950. *Annales des Sciences Naturelles Botanique* 12:223–363.
- Manhart, J. R., Fryxell, G. A., Villac, M. C. & Segura, L. Y. 1995. *Pseudo-nitzschia pungens* and *P. multiseriata* (Bacillariophyceae): Nuclear rDNAs and species boundaries. *Journal of Phycology*, 31:421–427.
- Mann, A. 1907. Report on the diatoms of the Albatross Voyages in the Pacific Ocean, 1888–1904. *Contributions from the United States National Herbarium* 10(5):221–419.
- Mann, D. G. 1978. "Studies in the family Nitzschiaceae (Bacillariophyta)," pp. XXXIII, 386, 146 plates, Ph.D. Dissertation, University of Bristol.
- Mann, D. G. 1981. Sieves and flaps: Siliceous minutiae in the pores of raphid diatoms. In "Proceedings of the Sixth Symposium on Recent and Fossil Diatoms" (R. Ross, ed.), pp. 279–300. Koeltz, Koenigstein.
- Mann, D. G. 1986. *Nitzschia* subgenus *Nitzschia* (notes for a monograph of the Bacillariaceae (2)). In "Proceedings of the 8th International Diatom Symposium" (M. Ricard, ed.), pp. 215–226. Koeltz, Koenigstein.
- Marino, D., Montresor, M., & Zingone, A. 1987. *Miralia thronsenii* gen. nov., sp. nov., a planktonic diatom from the Gulf of Naples. *Diatom Research* 2:205–211.
- Marino, D., Giuffrè, G., Montresor, M., & Zingone, A. 1991. An electron microscope investigation on *Chaetoceros minimus* (Levander) comb. nov. and new observations on *Chaetoceros thronsenii* (Marino, Montresor and Zingone) comb. nov. *Diatom Research* 6:317–326.
- Martin, J. L., Haya, K., Burrigge, L. E., & Wildish, D. J. 1990. *Nitzschia pseudodelicatissima*—A source of domoic acid in the Bay of Fundy, eastern Canada. *Marine Ecology Progress Series* 67:177–182.
- Medlin, L. K. 1990. Comparison of restriction endonuclease sites in the small subunit 16S-like rRNA gene from the major genera of the family Bacillariaceae. *Diatom Research* 5:63–71.
- Medlin, L. K., & Priddle, J. 1990. "Polar Marine Diatoms," pp. 214. British Antarctic Survey, Cambridge.
- Medlin, L. K., & Sims, P. A. 1993. The transfer of *Pseudoemotia doliolus* to *Fragilariopsis*. *Beihft zur Nova Hedwigia* 106:323–334.
- Medlin, L. K., Elwood, H. J., Stickle, S., & Sogin, M. L. 1991. Morphological and genetic variation within the diatom *Skeletonema costatum* (Bacillariophyta): Evidence for a new species, *Skeletonema pseudocostatum*. *Journal of Phycology* 27:514–524.
- Medlin, L. K., Williams, D. M., & Sims, P. A. 1993. The evolution of the diatoms (Bacillariophyta). I. Origin of the group and assessment of the monophyly of its major divisions. *European Journal of Phycology* 28:261–275.

- Meister, F. 1932. "Kieselalgen aus Asien," pp. 56. Verlag von Gebrüder Borntraeger, Berlin.
- Meister, F. 1937. Seltene und neue Kieselalgen II. *Berichte der Schweizerischen Botanischen Gesellschaft* 47:258–276.
- Mereschkowsky, C. 1902. Liste des Diatomées de la Mer Noire. *Scripta Botanica Horti Universitatis Petropolitanae* 19:1–42.
- Mereschkowsky, C. 1903. Les types de l'endochrome chez les Diatomées. *Scripta Botanica Horti Universitatis Petropolitanae* 21:107–193.
- Meunier, A. 1910. "Microplankton des Mers de Barents et de Kara," Duc d'Orleans Campagne Arctique de 1907, pp. 355. Bulens, Brussels.
- Meunier, A. 1913. Microplankton de la Mer Flamande. 1ère partie: Le genre "*Chaetoceros*" Ehr. *Mémoires du Musée Royal d'Histoire Naturelle de Belgique* 7(2):1–49.
- Müller, O. F. 1783. Om et besynderligt Væsen i Strandvandet. *Nye Samling af det Kongelige Danske Videnskabernes Selskabs Skrifter* 2:277–286.
- Müller-Melchers, F. C. 1953. New and little known diatoms from Uruguay and the South Atlantic coast. *Comunicaciones Botánicas del Museo de Historia Natural de Montevideo* 3(30):1–11.
- Nagumo, T., & Ando, K. 1985. Alluvium diatoms from Arakawa Lowland, Saitama Prefecture (3). The frustular morphology and taxonomic studies of *Cyclotella* sp. and *C. stylorum* Brightwell. *Bulletin of Nippon University, General Education* 14:205–215.
- Nagumo, T., & Kobayasi, H. 1985. Fine structure of three freshwater and brackish water species of the genus *Cyclotella* (Bacillariophyceae) *C. atomus*, *C. caspia* and *C. meduanae*. *Bulletin of Plankton Society of Japan* 32:101–109.
- Navarro, J. N. 1993. Three-dimensional imaging of diatom ultrastructure with high resolution low-voltage SEM. *Phycologia* 32:151–156.
- Nikolaev, V. A. 1983. On the genus *Symbolophora* (Bacillariophyta). *Botanicheskii Zhurnal* 68:1123–1128.
- Nikolaev, V. A. 1984. To the construction of the system of centric diatoms (Bacillariophyta). *Botanicheskii Zhurnal* 69:1468–1474. [In Russian]
- Norris, R. E. 1973. A new planktonic diatom, *Nanoneis hasleae* gen. et sp. nov. *Norwegian Journal of Botany* 20:321–325.
- O'Meara, E. 1877. On the diatomaceous gatherings made at Kerguelen's Land. *Journal of the Linnean Society (Botany)* 15:55–59.
- Ostenfeld, C. 1899. Plankton. In "Iagttagelser over overfladevandets temperatur, saltholdighed og plankton paa islandske og grønlandske skibsruter i 1899" (M. Knudsen & C. Ostenfeld, eds.), pp. 1–93. Bianco Luno, Copenhagen.
- Ostenfeld, C. H. 1900. Plankton in 1899. In "Iagttagelser over overfladevandets temperatur, saltholdighed og plankton paa islandske og grønlandske skibsruter i 1899" (M. Knudsen & C. Ostenfeld, eds.), pp. 43–93. Bianco Luno, Copenhagen.
- Ostenfeld, C. H. 1901a. Iagttagelser over plankton diatomeer. *Nyt Magazin for Naturvidenskaberne* 39:287–302.
- Ostenfeld, C. H. 1901b. Phytoplankton fra det Kaspiske Hav (Phytoplankton from the Caspian Sea). *Videnskabelige Meddelelser fra den naturhistoriske Forening i København* 1901:129–139.
- Ostenfeld, C. H. 1902. Marine plankton diatoms. *Botanisk Tidsskrift* 25(1):219–245.
- Ostenfeld, C. H. 1903. Phytoplankton from the sea around the Færøes. In "Botany of the Færøes Part 2," pp. 559–611. Det Nordiske Forlag, Ernst Bojesen, Copenhagen.
- Ostenfeld, C. H. 1910. List of diatoms and flagellates. *Meddelelser om Grønland* 43:259–285.
- Ostenfeld, C. H. 1915. A list of phytoplankton from the Boeton Strait, Celebes. *Dansk Botanisk Arkiv* 2(4):1–18.
- Ostenfeld, C. H., & Schmidt, J. 1901. Plankton fra det Røde Hav og Adenbugten. (Plankton from the Red Sea and the Gulf of Aden.) *Videnskabelige Meddelelser fra den naturhistoriske Forening i København* 1901:142–182.

- Østrup, E. 1895. Marine Diatoméer fra Østgrønland. *Meddelelser om Grønland* 18:395–476.
- Paasche, E. 1961. Notes on phytoplankton from the Norwegian Sea. *Botanica Marina* 2:197–210.
- Paasche, E. 1973. Silicon and the ecology of marine plankton diatoms. I. *Thalassiosira pseudonana* (*Cyclotella nana*) grown in a chemostat with silicate as limiting nutrient. *Marine Biology* 19:117–126.
- Paasche, E., Johansson, S., & Evensen, D. 1975. An effect of osmotic pressure on the valve morphology of the diatom *Skeletonema subsalsum*. *Phycologia* 14:205–211.
- Paddock, T. B. B. 1986. Observations on the genus *Stauropsis* Meunier and related species. *Diatom Research* 1:89–98.
- Paddock, T. B. B. 1988. *Plagiotropis* Pfitzer and *Tropidoneis* Cleve, a summary account. *Bibliotheca Diatomologica* 16:1–152.
- Paddock, T. B. B. 1990. Family Naviculaceae: The genera *Plagiotropis*, *Banquisia*, *Membraneis*, and *Manguinea*. In “Polar Marine Diatoms” (L. K. Medlin & J. Priddle, eds.), pp. 151–155. British Antarctic Survey, Cambridge.
- Paddock, T. B. B., & Sims, P. A. 1981. A morphological study of keels of various raphe-bearing diatoms. *Bacillaria* 4:177–222.
- Patrick, R., & Reimer, C. W. 1975. The diatoms of the United States 2(1). *Monographs of the Academy of Natural Sciences of Philadelphia* 13:vii–ix, 1–213.
- Paulsen, O. 1905. On some Peridineæ and Plankton-Diatoms. *Meddelelser fra Kommissionen for Havundersøgelser Serie Plankton* 1(3):1–7.
- Pavillard, J. 1911. Observations sur les Diatomées; (2e série). *Bulletin de la Société Botanique de France* 58:21–29.
- Pavillard, J. 1913. Observations sur les Diatomées. (2e série). *Bulletin de la Société Botanique de France* 60:126–133.
- Pavillard, J. 1916. Recherches sur les diatomées pélagiques du Golfe du Lion. *Travail de l'Institut de Botanique de l'Université de Montpellier, Série mixte—Mémoire* 5:7–62.
- Pavillard, J. 1921. Sur la reproduction du *Chaetoceros eibonii* Meunier. *Comptes Rendus des Séances de l'Académie des Sciences* 172:469–471.
- Pavillard, J. 1924. Observations sur les diatomées; (4e série). Le genre *Bacteriastrum*. *Bulletin de la Société Botanique de France* 71:1084–1090.
- Pavillard, J. 1925. Bacillariales. *Report on the Danish Oceanographical Expeditions 1908–1910 to the Mediterranean and adjacent seas* 2:1–72.
- Pelletan, J. 1889. Les Diatomées Histoire Naturelle, Préparation, Classification et description des principales espèces. *Journal de Micrographie* 2:364.
- Peragallo, H. 1888. Diatomées de la Baie de Villefranche. *Bulletin de la Société Histoire Naturelle Toulouse* 22:1–100.
- Peragallo, H. 1891. Monographie du genre *Pleurosigma*. In “Extrait du Diatomiste 1890–91” (J. Tempère, ed.), pp. 1–35.
- Peragallo, H. 1892. Monographie du genre *Rhizosolenia* et de quelques genres voisins. In “Le Diatomiste” (J. Tempère), Vol. 1, pp. 79–82, 99–117.
- Peragallo, H., & Peragallo, M. 1897–1908. “Diatomées marines de France” (M. J. Tempère, ed.), pp. 492, I–XII, pp. 48, 135 plates. Grez-sur-Loing.
- Peragallo, M. 1924. “Les diatomées marines de la première expédition Antarctique Française (1903–05),” pp. 27. Masson et Cie, Paris.
- Poulin, M. 1990. Family Naviculaceae: Arctic species. In “Polar Marine Diatoms” (L. K. Medlin & J. Priddle, eds.), pp. 137–148. British Antarctic Survey, Cambridge.
- Priddle, J., & Fryxell, G. 1985. “Handbook of the common plankton diatoms of the Southern Ocean,” pp. 159. British Antarctic Survey, Cambridge.
- Priddle, J., & Thomas, D. P. 1989. *Coscinodiscus bouvet* Karsten—A distinctive diatom which may be an indicator of changes in the Southern Ocean. *Polar Biology* 9:161–167.

- Priddle, J., Jordan, R. W., & Medlin, L. K. 1990. Family Rhizosoleniaceae. In "Polar Marine Diatoms" (L. K. Medlin & J. Priddle, eds.), pp. 115–127. British Antarctic Survey, Cambridge.
- Pritchard, R. 1861. "A History of Infusoria, Including the *Desmidiaceae* and *Diatomaceae*, *British and Foreign*," pp. 968, XII. Whittaker, London.
- Proschkina-Lavrenko, A. I. 1953. Species *Chaetoceros novae et curiosae* Maris Nigri I. *Botanicheskie materialy, Otdela sporovykh rastenii. Akademiya NAUK SSSR* 9:46–56.
- Proschkina-Lavrenko, A. I. 1955. "Diatomovye vodorosli planktona Chernogo Morya," pp. 222. Akademiya NAUK SSSR Botanicheskii Institut, Moskva–Leningrad. [in Russian]
- Proschkina-Lavrenko, A. I. 1961. Diatomeae novae e Mari Nigro (Ponto Euxino) et Azoviano (Maeotico). *Notulae systematicae e sectione cryptogamica URSS* 14:33–39.
- Ramsfjell, E. 1959. Two new phytoplankton species from the Norwegian Sea, the diatom *Coscinosira poroseriata*, and the dinoflagellate *Goniaulax parva*. *Nytt Magasin for Botanikk* 7:175–177.
- Rattray, J. 1890a. A revision of the genus *Coscinodiscus* and some allied genera. *Proceedings of the Royal Society of Edinburgh* 16:449–692.
- Rattray, J. 1890b. A revision of the genus *Actinocyclus* Ehrb. *Journal of the Quekett Microscopical Club, Series 2* 4:137–212.
- Reid, F. M. H., & Round, F. E. 1988. The Antarctic diatom *Synedra reinboldii*: Taxonomy, ecology and transfer to a new genus, *Trichotoxon*. *Diatom Research* 2:219–227.
- Reimann, B. E. F., & Lewin, J. C. 1964. The diatom genus *Cylindrotheca* Rabenhorst. *Journal of the Royal Microscopical Society* 83:283–296.
- Ricard, M. 1987. "Atlas du phytoplancton marin 2: Diatomophycees," pp. 297. Centre National de la Recherche Scientifique, Paris.
- Rines, J. E. B., & Hargraves, P. E. 1986. Considerations of the taxonomy and biogeography of *Chaetoceros ceratosporus* Ostf. and *Chaetoceros rigidus* Ostf. In "Proceedings of the 8th International Diatom Symposium" (M. Ricard, ed.), pp. 97–112. Koeltz, Koenigstein.
- Rines, J. E. B., & Hargraves, P. E. 1988. The *Chaetoceros* Ehrenberg (Bacillariophyceae) flora of Narragansett Bay, Rhode Island, U.S.A. *Bibliotheca Phycologica* 79:1–196.
- Rines, J. E. B., & Hargraves, P. E. 1990. Morphology and taxonomy of *Chaetoceros compressus* Lauder var. *hirtisetus* var. nova, with preliminary consideration of closely related taxa. *Diatom Research* 5:113–127.
- Rivera, P. 1981. Beiträge zur Taxonomie und Verbreitung der Gattung *Thalassiosira* Cleve. *Bibliotheca Phycologica* 56:1–220, 71 plates.
- Rivera, P. 1983. A guide for references and distribution for the class Bacillariophyceae in Chile between 18°28'S and 58°S. *Bibliotheca Diatomologica* 3:1–386.
- Rivera, P. 1985. Las especies del genero *Nitzschia* Hassall, seccion *Pseudo-nitzschia* (Bacillariophyceae), en las aguas marinas chilenas. *Gayana Botanica* 42:9–38.
- Rivera, P., & Koch, P. 1984. Contributions to the diatom flora of Chile II. In "Proceedings of the 7th International Diatom Symposium" (D. G. Mann, ed.), pp. 279–298. Koeltz, Koenigstein.
- Rivera, P. S., Avaria, S., & Barrales, H. L. 1989. *Ethmodiscus rex* collected by net sampling off the coast of northern Chile. *Diatom Research* 4:131–142.
- Roper, F. C. S. 1858. Notes on some new species and varieties of British marine diatomaceæ. *Quarterly Journal of Microscopical Science* 6:17–25.
- Ross, R., & Sims, P. A. 1971. Generic limits in the Biddulphiaceae as indicated by the scanning electron microscope. In "Scanning Electron Microscopy" (V. H. Heywood, ed.), pp. 155–176. Academic Press, New York.
- Ross, R., & Sims, P. A. 1973. Observations on family and generic limits in the Centrales. *Beiheft zur Nova Hedwigia* 45:97–128.
- Ross, R., Sims, P. A., & Hasle, G. R. 1977. Observations on some species of the Hemiauloideae. *Beiheft zur Nova Hedwigia* 54:179–213.



- Ross, R., Cox, E. J., Karayeva, N. I., Mann, D. G., Paddock, T. B. B., Simonsen, R., & Sims, P. A. 1979. An amended terminology for the siliceous components of the diatom cell. *Beiheft zur Nova Hedwigia* 64:513–533.
- Round, F. E. 1972. Some observations on colonies and ultra structure of the frustule of *Coenobiodiscus muriformis* and its transfer to *Planktoniella*. *Journal of Phycology* 8:221–231.
- Round, F. E. 1973. On the diatom genera *Stephanopyxis* Ehr. and *Skeletonema* Grev. and their classification in a revised system of the Centrales. *Botanica Marina* 16:148–154.
- Round, F. E. 1980. Forms of the giant diatom *Ethmodiscus* from the Pacific and Indian Oceans. *Phycologia* 19:307–316.
- Round, F. E., & Crawford, R. M. 1981. The lines of evolution of the Bacillariophyta. 1. Origin. *Proceedings of the Royal Society London B* 211:237–260.
- Round, F. E., & Crawford, R. M. 1984. The lines of evolution of the Bacillariophyta. 2. The centric series. *Proceedings of the Royal Society London B* 221:169–188.
- Round, F. E., & Crawford, R. M. 1989. Phylum Bacillariophyta. In “Handbook of Protoctista” (L. Margulis, J. O. Corliss, M. Melkonian, & D. J. Chapman, eds.), pp. 574–596. Jones and Barlett, Boston.
- Round, F. E., Crawford, R. M., & Mann, D. G. 1990. “The Diatoms, Biology & Morphology of the Genera,” pp. 747. Cambridge University Press, Cambridge.
- Sancetta, C. 1987. Three species of *Coscinodiscus* Ehrenberg from North Pacific sediments examined in the light and scanning electron microscopes. *Micropaleontology* 33:230–241.
- Sancetta, C. 1990. Occurrence of Thalassiosiraceae (Bacillariophyceae) in two fjords of British Columbia. *Beiheft zur Nova Hedwigia* 100:199–215.
- Schmid, A.-M. 1990. Interclonal variation in the valve structure of *Coscinodiscus wailesii* Gran et Angst. *Beiheft zur Nova Hedwigia* 100:101–119.
- Schmid, A.-M., & Volcani, B. E. 1983. Wall morphogenesis in *Coscinodiscus wailesii* Gran and Angst. I. Valve morphology and development of its architecture. *Journal of Phycology* 19:387–402.
- Schmidt, A., continued by Schmidt, M., Fricke, F., Heiden, H., Müller, O., & Hustedt, F. 1874–1959. “Atlas der Diatomaceenkunde.” Reiland, Leipzig.
- Schrader, H.-J. 1972. *Thalassiosira parthenia*, eine neue Gallertlager bildende zentrale Diatomee. “Meteor” *Forschungs-Ergebnisse Reihe D* 10:58–64.
- Schröder, B. 1906. Beiträge zur Kenntnis des Phytoplanktons warmer Meere. *Vierteljahrsschrift der Naturforschenden Gesellschaft in Zürich* 51:319–377.
- Schröder, B. 1911. Adriatisches Phytoplankton. *Aus den Sitzungsberichten der kaiserlichen Akademie der Wissenschaften in Wien, Mathematische-naturwissenschaftliche Klasse* 70(1):1–57.
- Schuette, G., & Schrader, H. 1982. *Thalassiothrix pseudonitzschioides* sp. nov.: A common pennate diatom from the Gulf of California. *Bacillaria* 5:213–223.
- Schultze, M. 1858. Innere Bewegungserscheinungen bei Diatomeen der Nordsee aus den Gattungen *Coscinodiscus*, *Denticella*, *Rhizosolenia*. *Archiv für Anatomie, Physiologie und wissenschaftliche Medizin* 1858:330–342.
- Schultze, M. 1859. Innere Bewegungserscheinungen bei Diatomeen der Nordsee aus den Gattungen *Coscinodiscus*, *Denticella*, *Rhizosolenia*. *Archiv für Anatomie, Physiologie und wissenschaftliche Medizin* 1858:330–342. Translated as Phenomena of internal movements in diatomaceæ of the North Sea, belonging to the genera *Coscinodiscus*, *Denticella*, and *Rhizosolenia*. *Quarterly Journal of Microscopical Science* 7:13–21.
- Schütt, F. 1892. Das Pflanzenleben der Hochsee. *Ergebnisse der Plankton-Expedition der Humboldt-Stiftung* IA:243–314.
- Schütt, F. 1895. Arten von *Chaetoceros* und *Peragallia*. Ein Beitrag zur Hochseeflora. *Berichte der deutschen botanischen Gesellschaft* 13:35–48.

- Schütt, F. 1896. Bacillariales. In "Die natürlichen Pflanzenfamilien" (A. Engler & K. Prantl, eds.), Vol. I, 1b, pp. 31–150.
- Semina, H. J. 1956. De specie nova generis *Denticula* Ktz. notula. *Notulae systematicae e sectione cryptogamica URSS* 11:82–84.
- Semina, H. J. 1981a. De specie nova *Thalassiosirae* Cl. (Bacillariophyta) ex Antarctica notula. *Novitates systematicae plantarum non vascularium* 18:31–33.
- Semina, H. J. 1981b. Morphology and distribution of a tropical *Denticulopsis*. In "Proceedings of the 6th Symposium on Recent and Fossil Diatoms" (R. Ross, ed.), pp. 179–187.
- Semina, H. J., & Sergeeva, O. M. 1980. Morphology of certain diatom species from the White Sea. *Biologiya Morya* 1:34–37. [In Russian]
- Shadbolt, G. 1854. A short description of some new forms of diatomaceae from Port Natal. *Transactions of the Microscopical Society of London* 2:13–18.
- Shrubsole, W. H. 1890. On a new diatom in the estuary of the Thames. *Journal of the Quekett Microscopical Club, Serie 2* 4:259–262.
- Silva, P. C., & Hasle, G. R. 1993. Proposal to conserve *Thalassiothrix* Cleve et Grunow (Bacillariophyceae) with a conserved type. *Taxon* 42:125–127.
- Silva, P. C., & Hasle, G. R. 1994. Proposal to conserve Thalassiosiraceae against Lauderiacae and Planktoniellaceae (Algae). *Taxon* 43:287–289.
- Simonsen, R. 1972. Über die Diatomeengattung *Hemidiscus* Wallich und andere Angehörige der sogenannten "Hemidiscaceae." *Veröffentlichungen des Instituts für Meeresforschung in Bremerhaven* 13:265–273.
- Simonsen, R. 1974. The diatom plankton of the Indian Ocean Expedition of RV "Meteor" 1964–1965. "Meteor" *Forschungsergebnisse Reihe D* 19:1–107.
- Simonsen, R. 1975. On the pseudonodulus of the centric diatoms, or Hemidiscaceae reconsidered. *Beiheft zur Nova Hedwigia* 53:83–94.
- Simonsen, R. 1979. The diatom system: Ideas on phylogeny. *Bacillaria* 2:9–71.
- Simonsen, R. 1982. Note on the diatom genus *Charcotia* M. Peragallo. *Bacillaria* 5:101–116.
- Simonsen, R. 1987. "Atlas and catalogue of the diatom types of Friedrich Hustedt. 1, Catalogue, pp. 525; 2 & 3, atlas, 772 plates. Cramer, Berlin–Stuttgart.
- Simonsen R. 1992. The diatom types of Heinrich Heiden in Heiden & Kolbe 1928. *Bibliotheca Diatomologica* 24:1–100.
- Simonsen, R., & Kanaya, T. 1961. Notes on the marine species of the diatom genus *Denticula* Kütz. *Internationale Revue gesamten Hydrobiologie* 46:498–513.
- Sims, P. A. 1990. The fossil diatom genus *Fenestrella*, its morphology, systematics and palaeogeography. *Beiheft zur Nova Hedwigia* 100:277–288.
- Sims, P. A. 1994. *Skeletonemopsis*, a new genus based on the fossil species of the genus *Skeletonema* Grev. *Diatom Research* 9:387–410.
- Sims, P. A., & Hasle G. R. 1990. The formal establishment of the family Stellarimaceae Nikolaev ex Sims & Hasle. *Diatom Research* 5:207–208.
- Sims, P. A., Fryxell, G. A., & Baldauf, J. G. 1989. Critical examination of the diatom genus *Azpeitia*: Species useful as stratigraphic markers for the Oligocene and Miocene Epochs. *Micropaleontology* 35:293–307.
- Smith, W. 1853–1856. "A Synopsis of the British Diatomaceae," pp. 89, 107. Van Voorst, London.
- Smith, J. C., Pauley, K., Cormier, P., Angus, R., Odense, P., O'Neil, D., Quilliam, M. A., & Worms, J. 1991. Population dynamics and toxicity of various species of *Dinophysis* and *Nitzschia* from the southern Gulf of St. Lawrence. In "Proceedings of the Second Canadian Workshop on Harmful Marine Algae. Bedford Institute of Oceanography, Dartmouth, Nova Scotia. October 2–4 1990" (D. C. Gordon, Jr, ed.) p. 24. (*Canadian Technical Report on Fisheries and Aquatic Sciences* 1799).
- Sournia, A. 1968. Diatomées planctoniques du Canal de Mozambique et de l'île Maurice. *Mémoire O.R.S.T.O.M.* 31:1–120.

- Sournia, A. (ed.) 1978. Phytoplankton manual. In "Monographs on Oceanographic Methodology 6," pp. 337. UNESCO, Paris.
- Sournia, A., Grall, J.-R., & Jacques, G. 1979. Diatomées et dinoflagellés d'une coupe méridienne dans le sud de l'océan Indien. *Botanica Marina* 22:183–198.
- Sournia, A., Chrétiennot-Dinet, M.-J., & Ricard, M. 1991. Marine Phytoplankton: How many species in the world? *Journal of Plankton Research* 13:1093–1099.
- Stein, J. R. (ed.) 1973. "Handbook of Phycological Methods," pp. 448. Cambridge University Press, London.
- Sterrenburg, F. A. S. 1991a. Studies on the genera *Gyrosigma* and *Pleurosigma* (Bacillariophyceae). The Typus Generis of *Pleurosigma*, some presumed varieties and imitative species. *Botanica Marina* 34:561–573.
- Sterrenburg, F. A. S. 1991b. Studies on the genera *Gyrosigma* and *Pleurosigma* (Bacillariophyceae). Light microscopical features for taxonomy. *Diatom Research* 6:367–389.
- Stolterfoth, H. 1879. On a new species of the genus *Eucampia*. *Journal of Royal Microscopical Society* 2:835–836.
- Strelnikova, N. I., & Nikolaev, V. A. 1986. A contribution to the revision of the genera *Stephanopyxis* and *Pyxidicula*. *Botanicheskii Zhurnal, Akademiya NAUK SSSR* 71:950–953. [In Russian]
- Subba Rao, D. V., & Wohlgeschaffen, G. 1990. Morphological variants of *Nitzschia pungens* Grunow f. *multiseries* Hasle. *Botanica Marina* 33:545–550.
- Sundström, B. G. 1980. *Rhizosolenia phuketensis* sp. nov. and *Rhizosolenia stolterfothii* H. Peragallo (Bacillariophyceae). *Botaniska Notiser* 133:579–583.
- Sundström, B. G. 1984. Observations on *Rhizosolenia clevei* Ostenfeld (Bacillariophyceae) and *Richelia intracellularis* Schmidt (Cyanophyceae). *Botanica Marina* 27:345–355.
- Sundström, B. G. 1986. The marine diatom genus *Rhizosolenia*, pp. 117, 39 plates. Doctoral Dissertation. Lund University, Lund, Sweden.
- Syvrtsen, E. E. 1977. *Thalassiosira rotula* and *T. gravida*: Ecology and morphology. *Beiheft zur Nova Hedwigia* 54:99–112.
- Syvrtsen, E. E. 1979. Resting spore formation in clonal cultures of *Thalassiosira antarctica* Comber, *T. nordenskiöldii* Cleve and *Detonula confervacea* (Cleve) Gran. *Beiheft zur Nova Hedwigia* 64:41–63.
- Syvrtsen, E. E. 1984. Morphology of the arctic, planktonic *Navicula pelagica* (Bacillariophyceae), with special reference to the "setae." *Nordic Journal of Botany* 4:725–728.
- Syvrtsen, E. E. 1985. Resting spore formation in the Antarctic diatoms *Coscinodiscus furcatus* Karsten and *Thalassiosira australis* Peragallo. *Polar Biology* 4:113–119.
- Syvrtsen, E. E. 1986. *Thalassiosira hispida* sp. nov., a marine planktonic diatom. In "Proceedings of the 8th International Diatom Symposium" (M. Ricard, ed.), pp. 33–42. Koeltz, Koenigstein.
- Syvrtsen, E. E. 1991. Ice algae in the Barents Sea: Types of assemblages, origin, fate and role in the ice-edge phytoplankton bloom. *Polar Research* 10:277–287.
- Syvrtsen, E. E., & Hasle, G. R. 1982. The marine planktonic diatom *Lauderia annulata* Cleve, with particular reference to the processes. *Bacillaria* 5:243–256.
- Syvrtsen, E. E., & Hasle, G. R. 1983. The diatom genus *Eucampia*: Morphology and taxonomy. *Bacillaria* 6:169–210.
- Syvrtsen, E. E., & Hasle, G. R. 1984. *Thalassiosira bulbosa* Syvrtsen, sp. nov., an Antarctic marine diatom. *Polar Biology* 3:167–172.
- Syvrtsen, E. E., & Hasle, G. R. 1988. *Melosira arctica* in the Baltic Sea and in the Oslofjord (a preliminary note). *USDQR Report* 12:79–84.
- Syvrtsen, E. E., & Lange, C. B. 1990. *Porosira pentaportula* Syvrtsen & Lange, sp. nov. (Bacillariophyceae), a marine planktonic diatom. *Beiheft zur Nova Hedwigia* 100:143–151.
- Takahashi, K., Jordan, R. & Priddle, J. 1994. The diatom genus *Proboscia* in subarctic waters. *Diatom Research* 9:411–428.

- Takano, H. 1956. Harmful blooming of minute cells of *Thalassiosira decipiens* in coastal water in Tokyo Bay. *Journal of Oceanographical Society of Japan* 12:63–67.
- Takano, H. 1965. New and rare diatoms from Japanese marine waters—I. *Bulletin of Tokai Regional Fisheries Research Laboratory* 42:1–10.
- Takano, H. 1968. On the diatom *Chaetoceros calcitrans* (Paulsen) emend. and its dwarf form *pumilus* forma nov. *Bulletin of Tokai Regional Fisheries Research Laboratory* 55:1–7.
- Takano, H. 1976. Scanning electron microscopy of diatoms—II. *Thalassiosira mala* Takano. *Bulletin of Tokai Fisheries Research Laboratory* 87:57–65.
- Takano, H. 1979. New and rare diatoms from Japanese marine waters—III. *Lithodesmium variable* sp. nov. *Bulletin of Tokai Regional Fisheries Research Laboratory* 100:35–43.
- Takano, H. 1980. New and rare diatoms from Japanese marine waters—V. *Thalassiosira tealata* sp. nov. *Bulletin of Tokai Regional Fisheries Research Laboratory* 103:55–63.
- Takano, H. 1981. New and rare diatoms from Japanese marine waters—VI. Three new species in Thalassiosiraceae. *Bulletin of Tokai Regional Fisheries Research Laboratory* 105:31–43.
- Takano, H. 1982. New and rare diatoms from Japanese marine waters—VIII. *Neodelphineis pelagica* gen. et sp. nov. *Bulletin Tokai Regional Fisheries Research Laboratory* 106:45–51.
- Takano, H. 1983. New and rare diatoms from Japanese marine waters—XI. Three new species epizoic on copepods. *Bulletin Tokai Regional Fisheries Research Laboratory* 111:23–35.
- Takano, H. 1984. Scanning electron microscopy of diatoms—VII. *Odontella aurita* and *O. longicruris*. *Bulletin of Tokai Regional Fisheries Research Laboratory* 113:79–85.
- Takano, H. 1985. Two new diatoms in the genus *Thalassiosira* from Japanese marine waters. *Bulletin of Tokai Regional Fisheries Research Laboratory* 116:1–11.
- Takano, H. 1990. Diatoms. In “Red tide organisms in Japan—An illustrated taxonomic guide” (Y. Fukuyo, H. Takano, M. Chihara, & K. Matsouka, eds.), pp. 162–331. Uchida Rokakuho, Tokyo.
- Takano, H. 1993. Marine Diatom *Nitzschia multiseriata* sp. nov. Common at Inlets of Southern Japan. *Diatom, The Japanese Journal of Diatomology* 8:39–41.
- Takano, H., & Kikuchi, K. 1985. Anomalous cells of *Nitzschia pungens* Grunow found in eutrophic marine waters. *Diatom, The Japanese Journal of Diatomology* 1:18–20.
- Takano, H., & Kuroki, K. 1977. Some diatoms in the section *Pseudo-nitzschia* found in coastal waters of Japan. *Bulletin of Tokai Regional Fisheries Research Laboratory* 91:41–51.
- Taylor, F. J. R. 1967. Phytoplankton of the south western Indian Ocean. *Nova Hedwigia* 12:433–476.
- Thomas, D. P., & Bonham, P. I. 1990. Family Leptocylindraceae: the genus *Corethron*. In “Polar Marine Diatoms” (L. K. Medlin & J. Priddle, eds.), pp. 105–107. British Antarctic Survey, Cambridge.
- Thomsen, H. A., Buck, K. R., Marino, D., Sarno, D., Hansen, L. E. Østergaard, J. B., & Krupp, J. 1993. *Lenmoxia faveolata* gen. et sp. nov. (Diatomophyceae) from South America, California, West Greenland and Denmark. *Phycologia* 32:278–283.
- Van Goor, A. C. J. 1924. Über einige neue und bemerkenswerte Schwebelagen. *Recueil des Travaux Botaniques Néerlandais* 21:297–328.
- Van Heurck, H. 1880–1885. “Synopsis des Diatomées de Belgique,” pp. 235, 132 Suppl. A, B, and C plates. Antwerp.
- Van Heurck, H. 1909. Diatomées. In “Expédition Antarctique Belge. Résultats du Voyage du S. Y. Belgica 1897–1899,” pp. 126. Buschmann. Antwerp.
- Vanlandingham, S. L. 1967–1979. “Catalogue of the Fossil and Recent Genera and Species of Diatoms and Their Synonyms. 1–8,” pp. 4653. Cramer, Lehre.
- Villareal, T. A., & Fryxell, G. A. 1983. The genus *Actinocyclus* (Bacillariophyceae): Frustule morphology of *A. sagittulus* sp. nov. and two related species. *Journal of Phycology* 19:452–466.

- Von Stosch, H. A. 1974. Pleurax, seine Synthese und seine Verwendung zur Einbettung und Darstellung der Zellwände von Diatomeen, Peridineen und anderen Algen, sowie für eine neue Methode zur Elektivfärbung von Dinoflagellaten-Panzern. *Archiv für Protistenkunde* 116(1,2):132–141.
- Von Stosch, H. A. 1975. An amended terminology of the diatom girdle. *Beiheft zur Nova Hedwigia* 53:1–28.
- Von Stosch, H. A. 1977. Observations on *Bellerochea* and *Streptotheca*, including descriptions of three new planktonic diatom species. *Beiheft zur Nova Hedwigia* 54:113–166.
- Von Stosch, H. A. 1980. The two *Lithodesmium* species (Centrales) of European waters. *Bacillaria* 3:7–20.
- Von Stosch, H. A. 1982. On auxospore envelopes in diatoms. *Bacillaria* 5:127–156.
- Von Stosch, H. A. 1986. Some marine diatoms from the Australian region, especially from Port Phillip Bay and tropical north-eastern Australia. *Brunonia* 8:293–348.
- Von Stosch, H. A. 1987. Some marine diatoms from the Australian region, especially from Port Phillip Bay and tropical north-eastern Australia. II. Survey of the genus *Palmeria* and of the family Lithodesmiaceae including the new genus *Lithodesmioides*. *Brunonia* 9:29–87.
- Von Stosch, H. A., & Fecher, K. 1979. "Internal thecae" of *Eunotia soleirolii* (Bacillariophyceae): Development, structure and function as resting spores. *Journal of Phycology* 15: 233–243.
- Von Stosch, H. A., Theil, G., & Kowallik, K. V. 1973. Entwicklungsgeschichtliche Untersuchungen an zentrischen Diatomeen. 5. Bau und Lebenszyklus von *Chaetoceros didymum*, mit Beobachtungen über einige andere Arten der Gattung. *Helgoländer wissenschaftlichen Meeresuntersuchungen* 25:384–445.
- Wallich, G. C. 1860. On the siliceous organisms found in the digestive cavities of the salpæ and their relation to the flint nodules of the chalk formation. *Transactions of the Microscopical Society New Series* 8:36–55.
- Watkins, T. P., & Fryxell, G. A. 1986. Generic characterization of *Actinocyclus*: Consideration in light of three new species. *Diatom Research* 1:291–312.
- West, T. 1860. Remarks on some diatomaceæ, new or imperfectly described, and a new desmid. *Transactions of the Microscopical Society of London New Series* 8:147–153.
- Williams, D. M. 1985. Morphology, taxonomy and interrelationships of the ribbed araphid diatoms from the genera *Diatoma* and *Meridion*. *Bibliotheca Diatomologica* 8:1–228, 27 plates.
- Williams, D. M. 1986. Comparative morphology of some species of *Synedra* Ehrenb. with a new definition of the genus. *Diatom Research* 1:131–152.
- Williams, D. M., & Round, F. E. 1986. Revision of the genus *Synedra* Ehrenb. *Diatom Research* 1:313–339.
- Williams, D. M., & Round, F. E. 1987. Revision of the genus *Fragilaria*. *Diatom Research* 2:267–288.
- Williams, R. C. 1953. A method for freeze drying for electron microscopy. *Experimental Cell Research* 4:188–201.
- Wilson, D. P. 1946. The triradiate and other forms of *Nitzschia closterium* (Ehrenberg) Wm. Smith, forma *minutissima* of Allen and Nelson. *Journal of the Marine Biological Association of the United Kingdom* 26:235–270.
- Wimpenny, R. S. 1946. The size of diatoms II. Further observations on *Rhizosolenia styloformis* (Brightwell). *Journal of the Marine Biological Association of the United Kingdom* 26:271–284.
- Wiseman, J. D. H., & Hendey, N. I. 1953. The significance and diatom content of a deep-sea floor sample from the neighbourhood of the greatest oceanic depth. *Deep-Sea Research* 1:47–59.

- Work, T. M., Beal, A. M., Fritz, L., Quilliam, M. A., Silver, M., Buck, K., & Wright, J. L. C. 1993. Domoic acid intoxication of brown pelicans and cormorants in Santa Cruz, California. In "Toxic Phytoplankton Blooms in the Sea" (T. J. Smayda & Y. Shimizu, eds.), pp. 643–664. Elsevier.
- Yanagisawa, Y., & Akiba, F. 1990. Taxonomy and phylogeny of the three marine diatom genera, *Crucidenticula*, *Denticulopsis*, and *Neodenticula*. *Bulletin of the Geological Survey of Japan* 41:197–301.
- Zacharias, O. 1905. *Rhizosolenia curvata mihi*, eine neue Planktondiatomee. *Archiv für Hydrobiologie und Planktonkunde* 1:120–121.

This Page Intentionally Left Blank

## Chapter 3

---

# Dinoflagellates

*Karen A. Steidinger and  
Karl Tangen*

### INTRODUCTION

---

#### GENERAL CHARACTERISTICS

The first evidence of dinoflagellates in the fossil record dates back to the Silurian. Free-living marine dinoflagellates are thus a very old and successful haplontic group of eukaryotic microorganisms adapted to a variety of pelagic and benthic habitats from arctic to tropical seas and estuaries as well as fresh to hypersaline waters. Many species are cosmopolitan and probably represent a complex of ecological strains. Based on morphology and cytology, their motile phase is distinctive at the light microscope level by the placement of two dimorphic flagella and the presence of a permanent fingerprint-like nucleus having continually condensed chromosomes. Biochemically, in addition to chlorophylls *a* and *c*, photosynthetic dinoflagellates have unique accessory pigments. Some species also produce potent neurotoxins.

At the ultrastructural level, dinoflagellates have a common thecal or cell covering structure that, along with their flagellar and nuclear characters, differentiates them from other algal groups. The theca can be smooth and relatively unornamented, as in some *Gymnodinium*, or it can constitute a cell wall of



polysaccharide plates with spines and flanges, as in *Pyrodinium*. Its basic structure is a series of membranes, sometimes with a pellicle layer and microtubules. Thecal vesicles usually constitute the second and third membranes (outer to inner), and can be empty, contain additional membranes, or, in the case of most armored forms, contain polysaccharides such as cellulose, mannose, or galactose. The term amphiesma is synonymous with theca, cortex, or cell covering; however, since much of the historical literature uses epitheca and hypotheca in taxonomic accounts, the term “theca” is the preferred term in this chapter in place of amphiesma or cell covering. Armored forms, either under stress or during reproduction (e.g., gamete formation and gamete fusion), are often capable of shedding their “armor” or a portion of the thecal membrane components leaving a viable spheroplast (Adamich & Sweeney, 1976) or a reproductive cell such as a gamete.

Dodge (1966) termed the dinoflagellate nucleus “mesokaryotic” because it possessed characters intermediate between the coiled DNA areas (2.5 nm) of prokaryotic bacteria and the well-defined eukaryotic nucleus. The 1N nucleus in nonparasitic species has condensed, banded chromosomes during interphase, a permanent nuclear envelope, a permanent nucleolus, and chromosomes attached to the nuclear envelope. The chromosomes are mostly DNA as demonstrated in electron micrographs in which the application of DNAase left little residue (Leadbeater, 1967). Biochemical analyses reveal the absence of typical histones and nucleosomes in most dinoflagellates analyzed although some basic nuclear proteins are present (Rizzo, 1987). Mitotic division, in most free-living species, is typically endonuclear starting with microtubules invading cytoplasmic channels and ending with typical anaphase and telophase.

The number of chromosomes per species or species complex varies from <10 to >500, with many species having upward of 100 for a 1N cell. Additionally, chromosome counts are often expressed as ranges due to fragmentation, aneuploidy, and technique problems. Recently developed fluorescence techniques to quantify DNA using DAPI can also be used to differentiate 1N from 2N cells and perhaps sibling species.

Although dinoflagellate nuclei are not characteristically eukaryotic because they lack histones, nucleosomes, and maintain continually condensed chromosomes during mitosis, this group of microalgae does have typical eukaryotic organelles such as chloroplasts, mitochondria, and golgi bodies.

Nutritional modes of dinoflagellates can vary from autotrophic to mixotrophic whereby photosynthetic cells may be phagotrophic—even on other dinoflagellates (Kimor, 1981; Gaines & Elbrächter, 1987). Heterotrophic species can have specialized structures, such as peduncles, used in phagocytizing other organisms. Food reserves in dinoflagellates are typically unsaturated fatty acids, starch, or both in the same individual cell (Dodge, 1973). Not all dinoflagellates are photosynthetic, particularly large open water pelagic species belonging to the genera *Protoperidinium* and *Gymnodinium* which can be

holozoic. Nearly half of the known extant dinoflagellate species are heterotrophic. Very few pelagic heterotrophic species reach high abundance; notable exceptions are *Protoperidinium depressum* and *Oxyrrhis marina*, which seasonally can attain large concentrations in estuarine or nearshore waters. Benthic heterotrophic species can also attain high concentrations, but their distribution, abundance, basic biology, and ecology remains relatively unstudied. Dinoflagellate bloom species that recur in specific areas are obviously adapted or acclimatized to their environmental regimes, e.g., water temperature, salinity, light, water circulation patterns, and nutrients. Light, for example, can influence vertical distribution, photosynthetic rates and efficiencies, chromatic adaptation and pigments, cellular nutrient pools, and metabolic pathways. Vertical migration behavior is thought to be related to positive geotaxis and secondarily influenced by light (Levandowsky & Kaneta, 1987). Temperature can influence photosynthetic and division rates, uptake and respiration rates, cell size, and successional patterns through interspecific competitive adaptations. Physiologically, dinoflagellates have varied strategies relative to the uptake and storage of resources, organic N and P utilization (e.g., alkaline phosphatase and hydroxamate siderophores) and utilization of vitamins, trace metals, and other growth factors. They also produce ectocrines that can inhibit other species, thus imparting a competitive advantage. Many of the environmental variables act synergistically on phytoplankton populations, not only on the dinoflagellates themselves but on associated bacterial populations.

Loeblich (1976) and Taylor (1980), among others advanced the theory that the Procoentrales constitute ancestral dinoflagellates which evolved into the advanced Peridinales and Gymnodinales through division of and then loss of plates. This theory may be supported by two lines of evidence, namely, the position of flagella compared to other algal groups and lower chromosome numbers as in *Prorocentrum*. A contrary position that unarmored forms preceded armored forms also exists. This speculation is supported by the theory of multiserial endosymbioses wherein photosynthetic dinoflagellates originated through heterotrophic forms phagocytizing chloroplast-bearing cells, perhaps prasinophytes or chrysophytes (Steidinger & Cox, 1980; Bujak & Williams, 1981). Support for this theory rests in the fossil record and the presence of thecal vesicles in unarmored forms. Another theory (Loeblich III in Spector, 1984) places *Oxyrrhis* as the ancestral dinoflagellate because of its cytological, biochemical, and reproductive features. However, without a better understanding of *Arpylorus* and fossil acritarchs from the Silurian as well as life cycles of extant dinoflagellates, any evolutionary projections are speculative.

Known toxic marine dinoflagellates, consisting of less than 60 of nearly 2000 extant species, vary little from nontoxic free-living dinoflagellates except (1) the majority are photosynthetic estuarine or neritic forms; (2) most probably produce benthic, sexual resting stages; (3) most are capable of producing monospecific or near monospecific populations above background levels, sug-

gesting competitive advantages through exclusion; and (4) all produce bioactive water-soluble and/or lipid-soluble substances that are cytolytic, hemolytic, hepatotoxic, or neurotoxic in activity depending on chemical structure and conversion state.

The question of what is a biological species still remains, particularly when dinoflagellate morphotypes and genotypes are discussed. Today, biochemical genetic markers are being pursued to assess species complexes and the distinctness of geographical isolates that have evolved over time/space. Morphology and cytology are still valid criteria, and in most cases the only available criteria, for separating dinoflagellate species, but these species should be termed morphospecies.

For more detailed reviews on dinoflagellate morphology, cytology, biochemistry, physiology, behavior, reproduction, and ecology see Dodge (1973), Steidinger & Cox (1980), Spector (1984), Pfister & Anderson (1987), Taylor (1987), Steidinger & Vargo (1988), Larsen & Sournia (1991), Fensome et al. (1993), and Steidinger (1993).

### DINOFLAGELLATES: EUKARYOTIC UNICELLS

**Flagella:** Two dimorphic; nonautofluorescent.

**Pigments:** Chl *a*, *c*<sub>2</sub>, betacarotene, peridinin, fucoxanthin, and its derivatives, and other xanthophylls. Some species with chl *c*<sub>1</sub>, chl *b*, phycobiliproteins, and/or other pigments, e.g., 19' hexanoyloxy-fucoxanthin associated with old or new symbioses.

**Nutrition:** Autotrophic, auxotrophic, and heterotrophic (saprophytic, phagocytic, and parasitic).

**Food Reserves:** Starch (polyglucan-like) and oil (long-chained unsaturated fatty acids—C14, C16, C18, and C22).

**Sterols:** >35 sterols, dinosterol, amphisterol, cholesterol, and 4,24-dimethylcholestanol dominate.

**Theca:** Multiple membrane complex w/vesicles, some species with scales.

**Nucleus:** Permanent nuclear envelope and nucleolus; continually condensed, banded chromosomes; phased DNA replication; most species haplont; mitosis closed; 4 to 500 chromosomes. No basic histones nor nucleosomes.

**Reproduction:** Asexual by binary fission; fission along predetermined plane; sexual—meiosis mostly postzygotic, isogamous to anisogamous, homothallic and heterothallic species, one heterothallic species w/ uniparental inheritance.

**Habitat:** Marine → freshwater, pelagic, benthic, symbionts, including parasites.

## TERMINOLOGY AND MORPHOLOGY

The following diagrams, text, and charts on dinoflagellate structure and interpretation are organized into convenient topics and layers of resolution in order to build upon existing knowledge. In the text, “aka” is equivalent to “also known as.”

### MORPHOLOGICAL TYPES

**Desmokont:** A dinoflagellate cell type in which two dissimilar flagella emerge from the anterior part of the cell. See dinokont.

**Dinokont:** A dinoflagellate cell type in which two flagella are inserted ventrally; one flagellum is transverse and housed in a cingulum (= girdle) and the other is longitudinal and housed in a sulcus. The transverse flagellum provides propulsion and the longitudinal flagellum provides direction. (Figs. 1 and 2).

### GENERAL CELL TERMS

**Antapex:** The posterior-most part of the cell body excluding spines, lists, and similar structures. This specific point of the cell may be difficult to determine. See Fig. 1B and Plate 50 schematic.

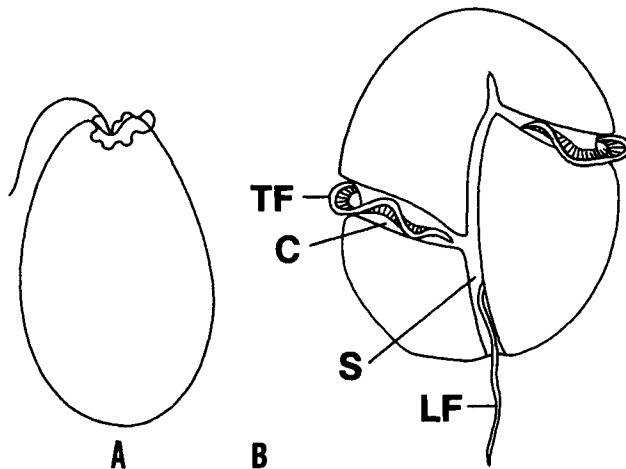

**FIGURE 1** (A) Lateral view of a desmokont cell illustrating anterior location of two dissimilar flagella. (B) Ventral view of dinokont cell type illustrating location of two dissimilar flagella, both housed in furrows. LF, longitudinal flagellum; TF, transverse flagellum; C, cingulum; S, sulcus.

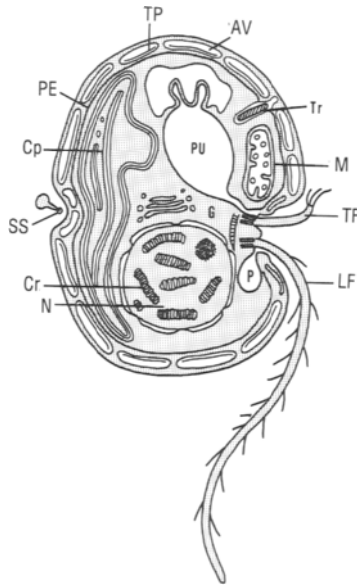

**FIGURE 2** Lateral view of dinokont cell illustrating insertion of flagella and typical dinophycean organelles. Thecal vesicle (AV) with thecal plate material (TP), chloroplast (Cp), chromosome (Cr), Golgi apparatus (G), longitudinal flagellum (LF), mitochondrion (M), nucleus (N), pellicle layer (PE), pusule (PU), striated strand (SS) of transverse flagellum (TF), trichocyst (Tr). Redrawn from Taylor (1980).

**Apex:** The anterior-most part of the cell. The apex is usually associated with the apical pore complex (APC) in the Peridinales, Gonyaulacales, and similar orders, or the apical groove in those unarmored species that have this feature. See **Plates 1–7**.

**Cingulum aka girdle, transverse groove:** In dinokont-type cells, this structure is usually a furrow encircling the cell once or several times; if several times, the cingulum is twisted around the cell and is considered “torsion.” See **Fig. 7**.

**Epitheca aka epicone aka episome:** The anterior part of the dinokont-type cell above the cingulum. See **Fig. 1B** and **Plate 50** schematic.

---

**PLATE 1** (A) *Katodinium glaucum*; (B) *Gymnodinium pulchellum*; (C) *Gymnodinium mikimotoi*; (D) *Gyrodinium* sp.; (E) *Gyrodinium instriatum*; (F) *Gyrodinium pepo*. Scale = 10  $\mu\text{m}$ . All micrographs courtesy of Dr. Haruyoshi Takayama.

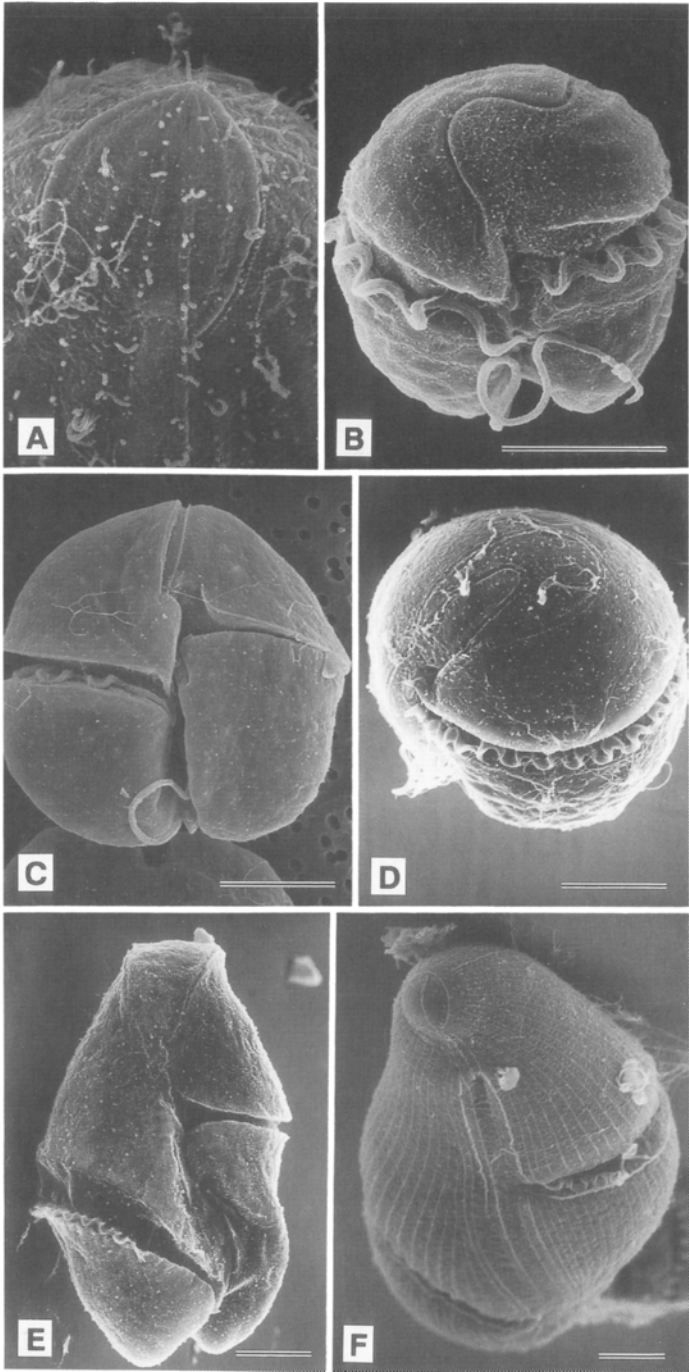

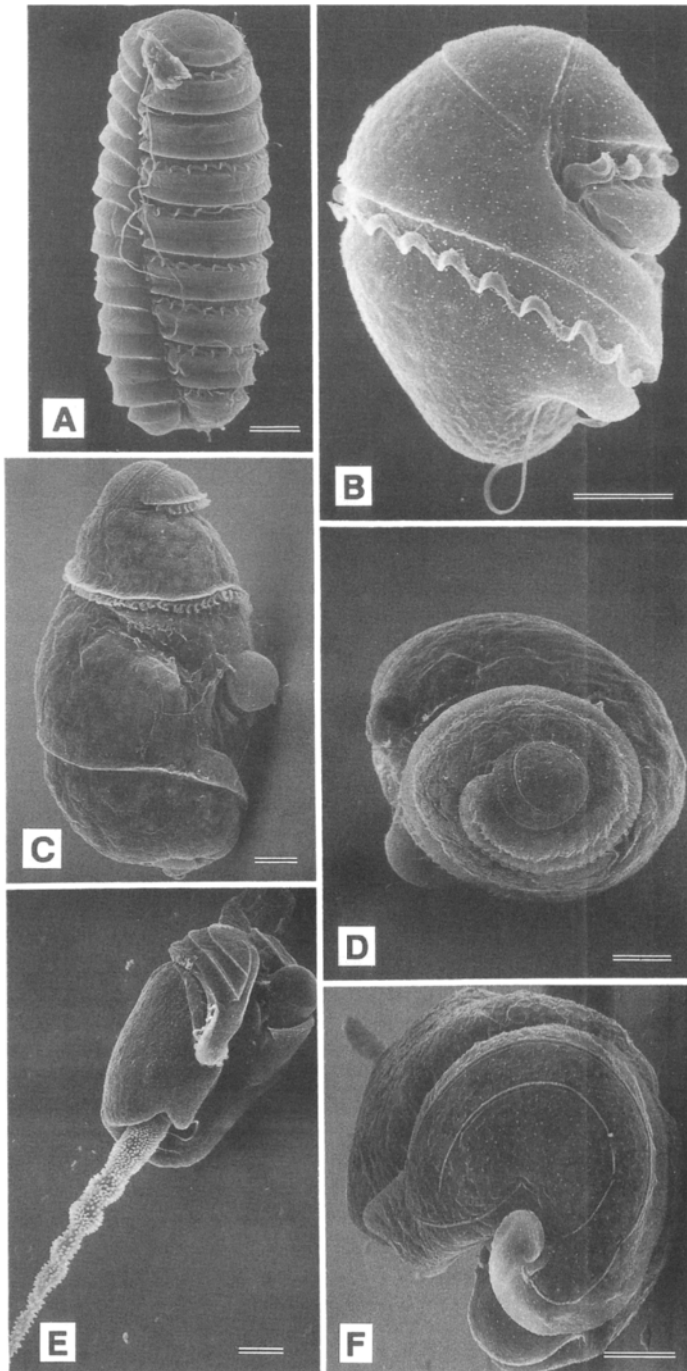

PLATE 2 (A) *Polykrikos schwartzii*; (B) *Nematodinium armatum*; (C) *Warnowia* sp. 1; (D) *Warnowia* sp. 1; (E) *Erythropsidinium agile*; (F) *Erythropsidinium agile*. Scale = 10  $\mu\text{m}$ . All micrographs courtesy of Dr. Haruyoshi Takayama.

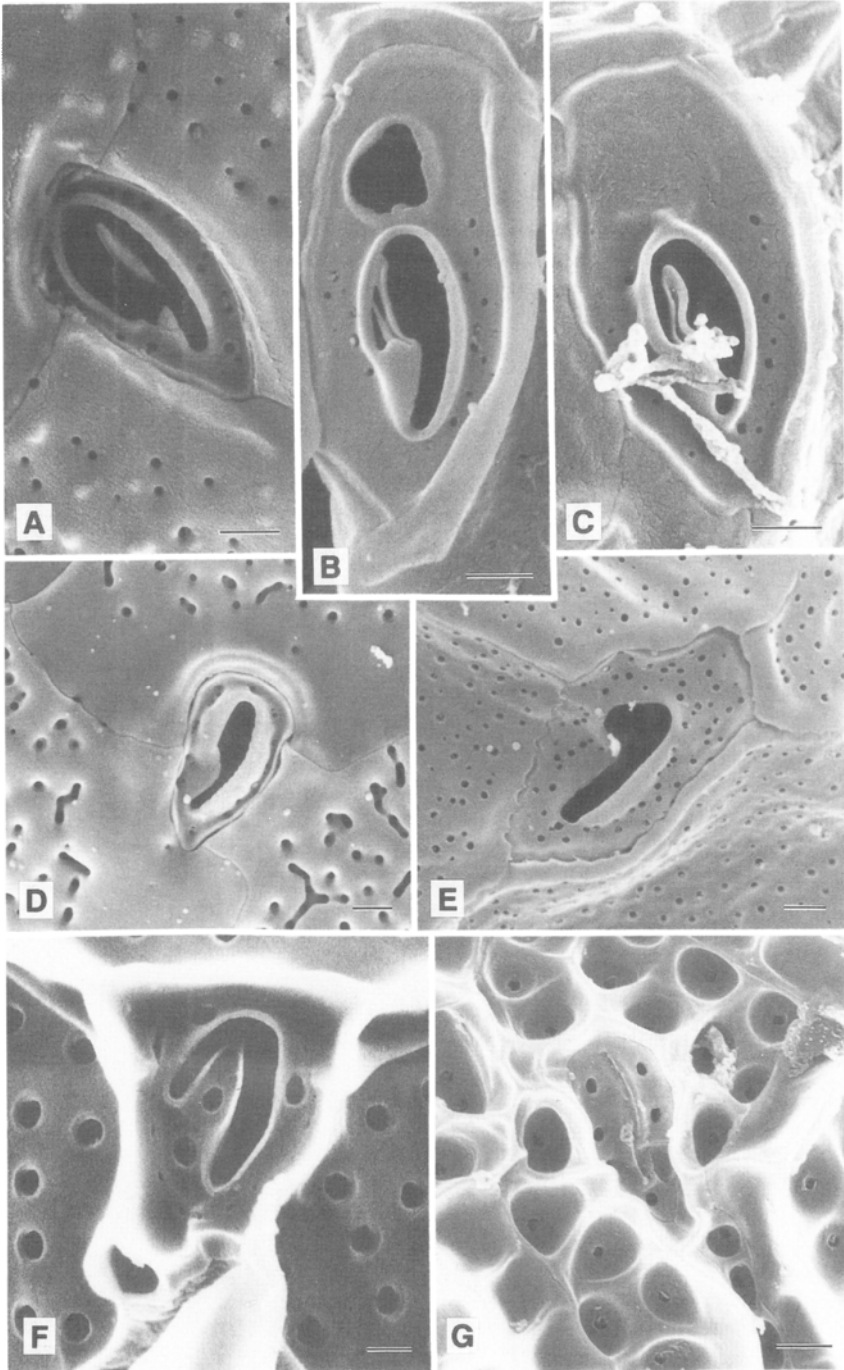

PLATE 3 (A) *Alexandrium balechii*; (B) *Alexandrium affine*; (C) *Alexandrium affine*; (D) *Alexandrium foedum*; (E) *Alexandrium monilatum*; (F) *Goniodoma polyedricum*; (G) *Ceratocorys armata* (scale = 2  $\mu\text{m}$ ). Scale = 1  $\mu\text{m}$  unless otherwise indicated.



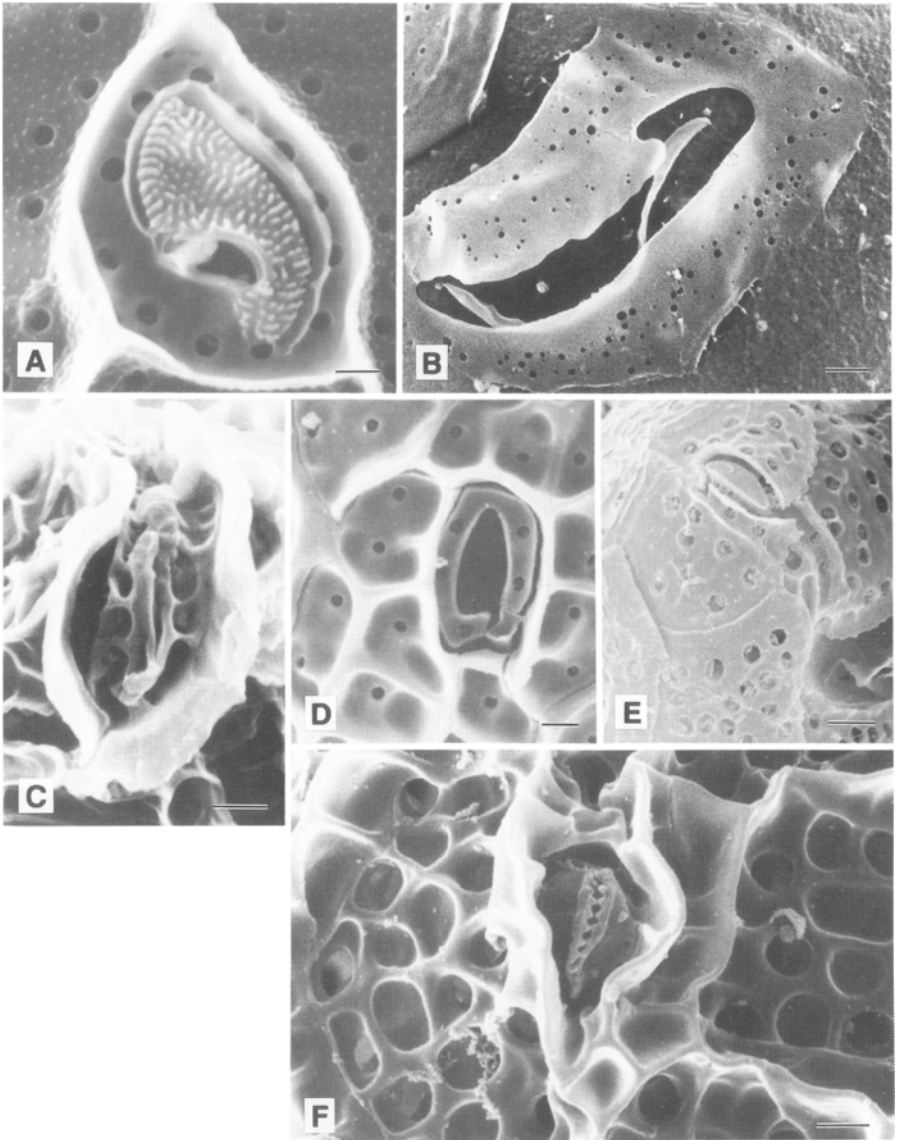

PLATE 4 (A) *Pyrodinium bahamense* var. *bahamense*; (B) *Fragilidium heterolobum*; (C) *Gonyaulax verior*; (D) *Gonyaulax grindleyi*; (E) *Gonyaulax* sp. (scale = 2  $\mu\text{m}$ ); (F) *Lingulodinium polyedrum*. Scale = 1  $\mu\text{m}$  unless otherwise indicated.

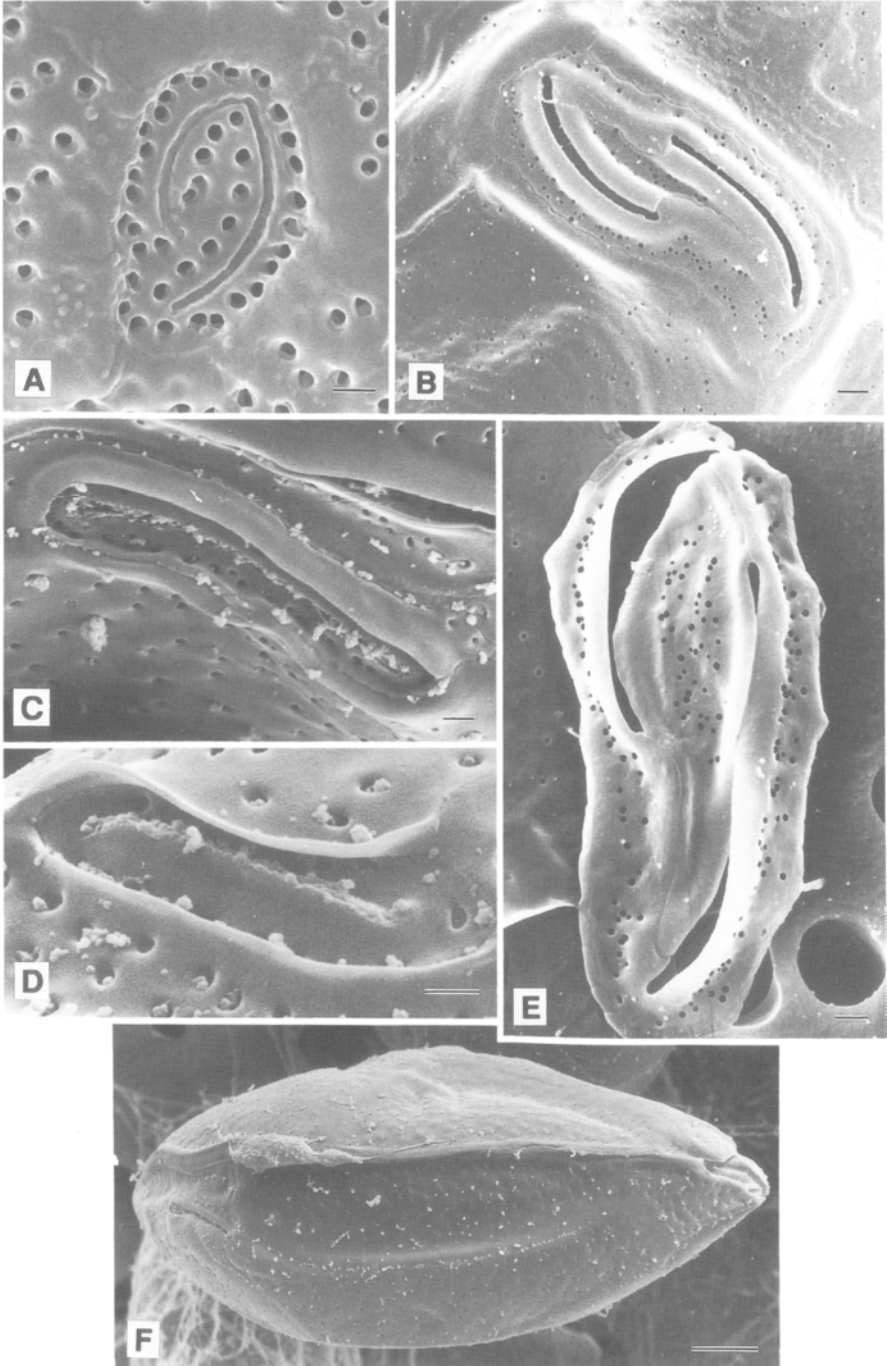

PLATE 5 (A) *Gambierdiscus toxicus*; (B) *Pyrophacus horologium*; (C) *Ostreopsis heptagona*; (D) *Coolia monotis*; (E) *Pyrophacus steinii*; (F) *Ostreopsis heptagona* (scale = 10  $\mu\text{m}$ ). Scale = 1  $\mu\text{m}$  unless otherwise indicated.

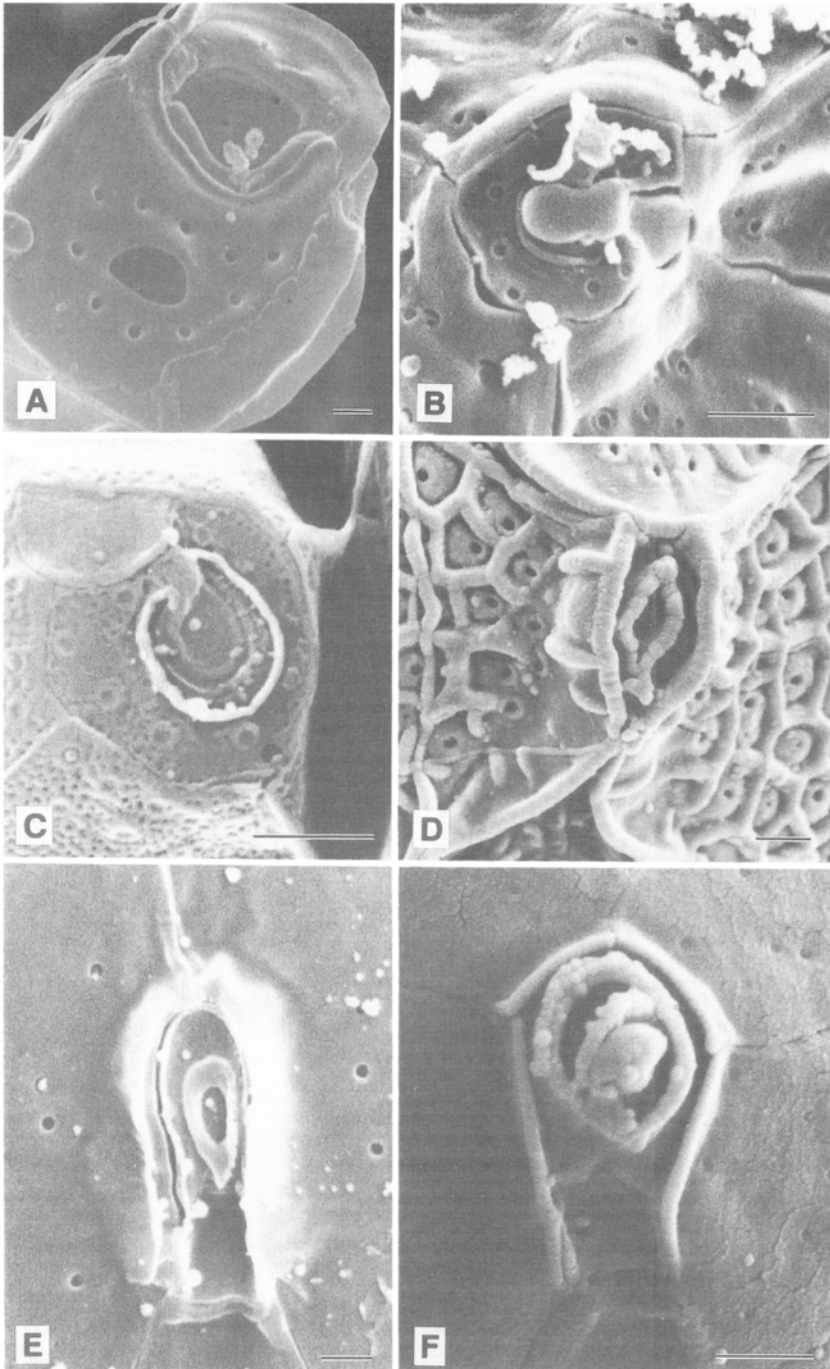
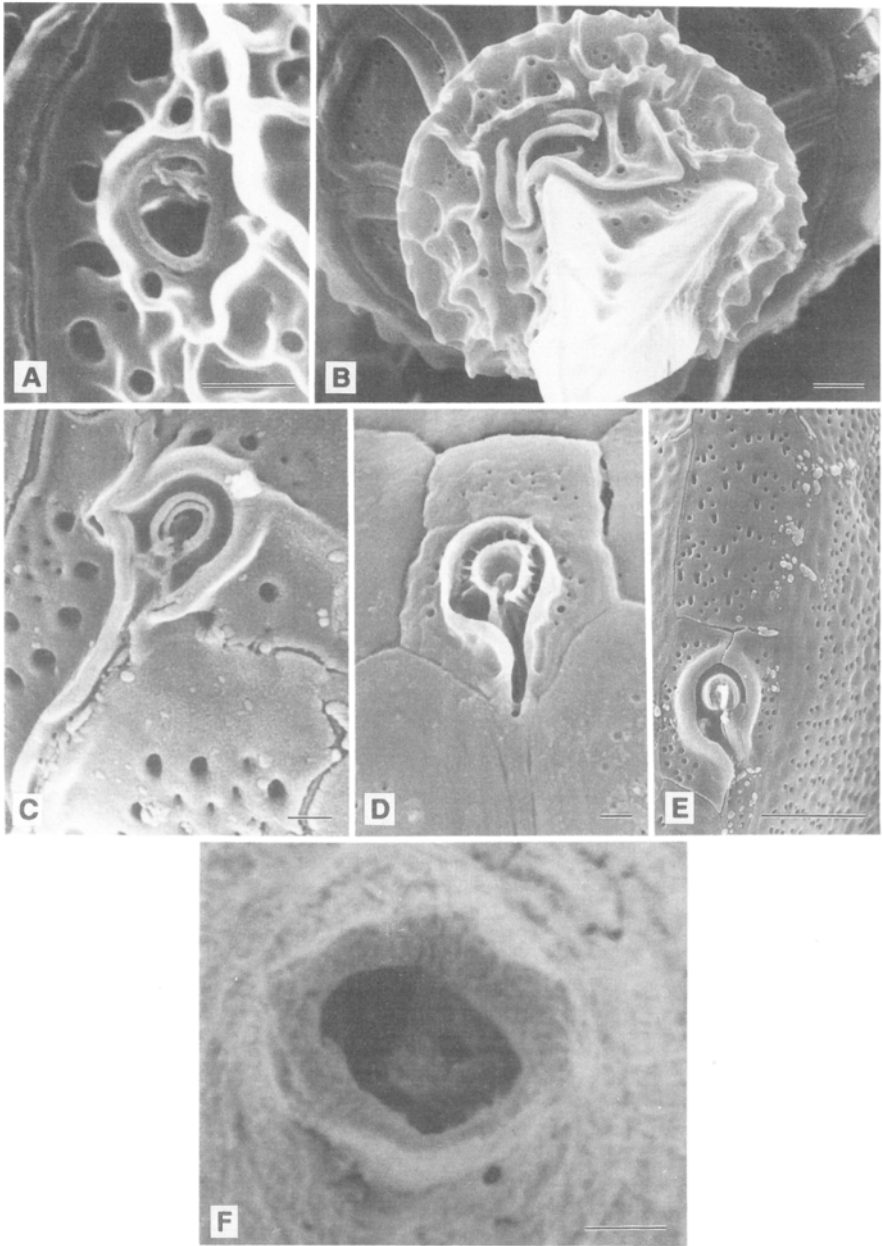

PLATE 6 (A) *Ceratium vultur*; (B) *Heterocapsa triquetra*; (C) *Heterocapsa niei*; (D) *Protoperidinium divergens*; (E) *Diplopelta bomba*; (F) *Scrippsiella trochoidea*. Scale = 1  $\mu$ m.



**PLATE 7** (A) *Oxytoxum scolopax*; (B) *Corythodinium constrictum*; (C) *Paleophalacroma uncinatum*; (D) *Blepharocysta* sp.; (E) *Lissodinium orcadense*; (F) *Podolampas bipes*. Scale = 1  $\mu\text{m}$ . D, E, and F courtesy of Consuelo Carbonell-Moore.

- Dorsal:** The dorsal side (back) of the dinokont-type cell is opposite the ventral side (front) where the sulcus is located. When using the light microscope to observe dinoflagellates, it is important to know whether you are focused on the ventral surface or whether you have focused through the dorsal side to the inside of the ventral surface. In the latter case, you will be observing a reversed image. Also see ventral. See Plate 18, *Gymnodinium mikimotoi*, Plates 24, 41, and 50 schematic.
- Flagellar pore(s):** All dinoflagellates at some time in their life cycle have two dissimilar flagella; these flagella either emerge through one pore or two separate pores. In at least two species of *Prorocentrum*, the two flagella emerge from one pore although there are two pores in the periflagellar plate area. In the dinokont-type cell there are typically two pores in the sulcal area although often only one pore is visible because the other pore is hidden by the ventral edge, the peduncle, or a sulcal plate.
- Hypotheca aka hypocone aka hyposome:** The posterior part of a dinokont-type cell below the cingulum.
- Lateral:** The lateral view of a cell is the left or right side view which usually represents the depth contour of a cell. In dinokonts, to orient to left and right, focus on the ventral surface with the sulcus and think of the left as the left side of the cell, not the left side of the microscope field. See Plate 18, *Gymnodinium breve*, and Plate 50 schematic.
- Left:** Plate series in armored dinokonts are tabulated or counted starting from the left side of the cell so that if a reference article mentions the shape of the sixth precingular as a diagnostic character, you have to be able to identify the 6<sup>th</sup> from other precingular plates. Unarmored dinoflagellates also have left sides; for example, the posterior left side may contain the nucleus. See right and lateral terms.
- Peduncle:** A cytoplasmic appendage located near the flagellar pores in some photosynthetic as well as nonphotosynthetic species. It is an extensible organelle associated with phagotrophy and may also have other functions.
- Pellicle:** The pellicle of some dinoflagellates is a chemically resistant layer which can give rigidity to an ecdysial cell or to other cells such as developing hypnozygotes. If present, it is below the outer thecal membrane, the top vesicle membrane, and the thecal plates. In the older literature, unarmored dinoflagellates with apparently thick cell coverings or ridges in the covering (e.g., in some *Gyrodinium* and *Gymnodinium*) were considered pelliculate and rigid. See Fig. 2.
- Right:** To orient to “right,” you first have to determine the ventral and dorsal surfaces of the cell. If you can equate a dinoflagellate cell with the human body, the right side is equivalent to the right arm, right leg, etc. If you were looking directly at the ventral surface of a dinokont cell it

would be on your left. However, if you have a reversed image either by focusing through a cell or because of the optics of the microscope, then the cell's right side appears as the left side. This is a critical determination and presents problems to those first working with dinoflagellates. See left term.

**Sulcus:** The longitudinal area on the ventral surface of the cell that forms a more or less pronounced furrow or depression that houses the longitudinal flagellum. In some armored species the sulcus, which is mainly in the hypotheca, invades the epitheca as a plate (the anterior sulcal or *sa*). In unarmored species it can be associated with an apical groove that has its origin anteriorly.

**Ventral:** The ventral side of the dinokont-type cell is identified by the presence of the sulcus and the juncture of the cingulum–sulcus. It is also the place of flagellar insertion in dinokonts.

## MICROANATOMY

**Nematocyst:** The ejectile organelles of *Nematodinium*, *Warnowia*, and some *Polykrikos*. Structurally, they have component parts called the posterior body and anterior operculum that are further divided into identifiable parts. They are often arranged radially or subradially in the cell. The nematocysts of *Nematodinium* and *Polykrikos* are structurally different. These organelles should not be equated to the stinging cells called cnidoblasts of cnidarians (Fig. 3).

**Ocellus aka ocelloid:** This organelle occurs in the Warnowiaceae and consists of a hyalosome, a dorsally pigmented melanosome, and an ocelloid chamber. This is a complex photoreceptor that can focus images and is sensitive to light. This organelle is typically located in the left part of the cell (Fig. 4).

**Pusule:** Organelle of variable complexity which may be regarded as a specialized vacuole opening through the cell surface usually in the flagellar area (Fig. 5).

**Theca aka amphiesma, cell covering, cell wall:** All dinoflagellates have a membrane system encompassing the whole cell consisting of a complex of three to six membranes. Different authors use different terms for this complex based on their own preference. The use of the term theca makes the use of epitheca and hypotheca more practical. See Fig. 2.

**Thecal plates:** Plates of armored dinoflagellates are composed of cellulose or some other polysaccharide microfibrils. These plates are formed in thecal vesicles which may or may not contain other membrane or osmophilic-staining structures.

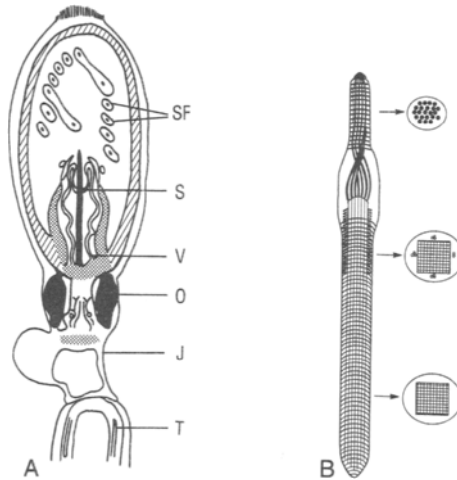

**FIGURE 3** (A) Nematocyst of *Polykrikos* with joining piece (J), the operculum (O), the striker (S), the spiral filament (SF), a toenocyst (T), and a valve (V). Redrawn from Taylor (1980). (B). Another ejectile organelle called a trichocyst (redrawn from Bouck & Sweeney (1966).

**Thecal vesicles:** These polygonal vesicles are membrane bound and usually compressed against one another in the cell covering or theca. The vesicles represent the second and third membrane profiles seen in cross section with an electron microscope.

### CHARACTERS USED IN IDENTIFYING PROROCENTROID DESMOKONT CELLS

**Metacytic growth zone:** The cell growth that occurs at the suture between the two valves of the Prorocentrales or the fissure halves of the Dinophysiales. When this usually horizontally striated zone is at its maximum extent, the cell will be at its greatest depth or width, respectively. See Fig. 6.

**Periflagellar plates:** Consist of the anterior plates or platelets around two pores, one of which is a flagellar pore. These plates typically indent the right valve.

**Pores aka trichocyst pores:** Pores are openings or channels in the theca of desmokonts and dinokonts that can be involved in pinocytosis, extrusion of trichocysts or mucocysts, and other active processes. Pore number and location are variable within a species, but in many groups, the pattern is genetically determined and consequently a reliable, but variable character for identification of species, e.g., within *Prorocentrum*.

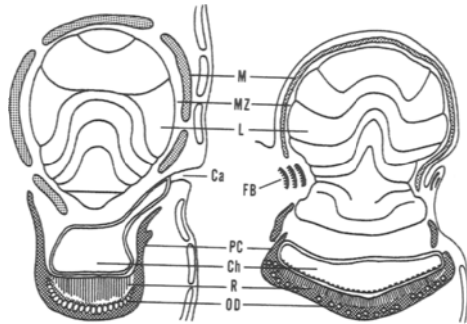

**FIGURE 4** Ocelli of *Nematodinium* and *Erythrospidinium* with the canal (Ca), fibrillar bands (FB), lens (L), mitochondrion (M), microtubular zone (MZ), pigment granules (OD), pigment cup (PC), chamber (Ch), and the retinoid (R). Redrawn from Taylor (1980).

**Valves:** In the Prorocentrales or thick-walled desmokonts, two opposing halves of the theca are called valves. The right valve is the one most indented anteriorly by the periflagellar plates.

## CHARACTERS USED IN IDENTIFYING DINOKONT CELLS

### Unarmored

Unarmored dinokont cells can be identified to family, genus, and species by a combination of characters using (1) size, shape, and proportions of living or well-fixed whole cells; (2) cingular position, displacement, and overhang; (3) sulcal placement and intrusion; (4) the presence/absence of thecal ridges; (5) the presence/absence of an apical groove, its shape, and relationship to the sulcus; (6) the presence/absence of a peduncle and position; and (7) the presence and location of organelles, e.g. nucleus, nematocysts, and ocelloid. Unarmored species can be biconical, round, ovoid, oblong, posteriorly bilobed, and various other descriptive shapes (Fig. 7).

**Apical groove aka acrobase:** A groove composed of many thecal vesicles resolved by silver staining; originally described as an acrobase with subcomponent parts. The groove itself, without the substructure, is called the apical groove and is located at the anterior part of many unarmored dinoflagellate cells. It can be straight, curved, or looped and extends posteriorly both on the ventral and on the dorsal sides but on the ventral surface it does not exceed the juncture with the sulcus. See **Plates 1 and 2**.

**Circular cingulum:** A cingulum which is not displaced and in which the proximal end meets the distal end. See Fig. 7C.



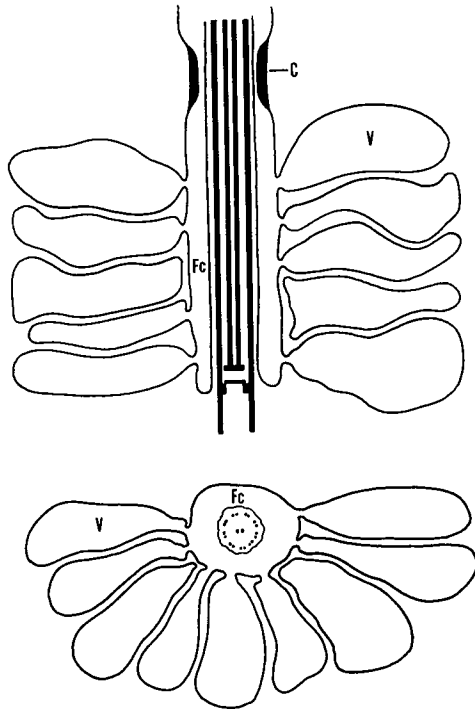

FIGURE 5 Pusule with flagellar pore constriction (C), flagellar canal (Fc), and pusule vesicles (V). Redrawn from Dodge & Crawford (1968).

**Displaced cingulum:** A cingulum in which the distal end is either above (ascending) or below (descending) the proximal end which is always on the left side of the cell. See Figs. 7A and 7E (descending) and Plate 54, *P. pellucidum*.

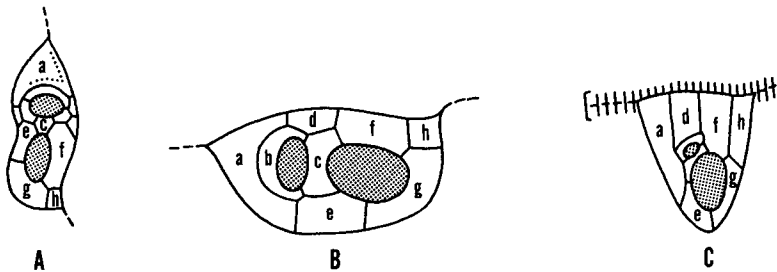
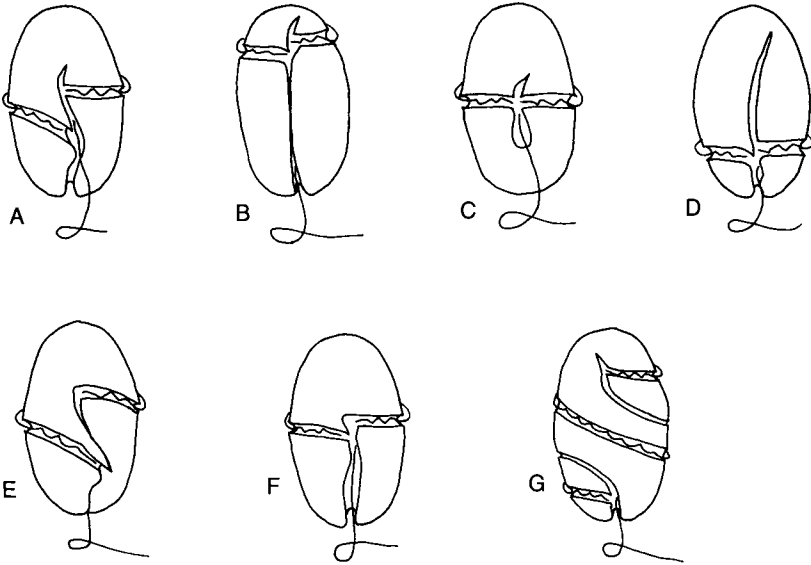

FIGURE 6 (A) *Prorocentrum micans*, (B) *Prorocentrum marinum*, and (C) *Prorocentrum lima*. Redrawn from Taylor (1980).



**FIGURE 7** (A) Displaced with sulcal intrusion onto the epitheca; (B) premedian; (C) median; (D) postmedian; (E) overhang; (F) displaced without cingular intrusion onto the epitheca; (G) torsion with the cingulum and sulcus going around the cell more than once.

**Median cingulum aka equatorial girdle:** The cingulum which is located approximately at the midpoint of the cell. See Fig. 7C.

**Postmedian cingulum:** A situation in dinokont-type cells when the cingulum is below the midpoint of the cell. See Fig. 7D.

**Premedian cingulum:** In dinokont-type cells when the cingulum is above the midpoint of the cell. See Fig. 7B.

**Unarmored aka naked, athecate:** Dinokont-type cells that do not have identifiable plate series and do not have apical pore complexes but may have an apical groove. More recently, scanning electron microscopy has revealed identifiable plate series in “gymnodinioid” dinokonts and those with an apical pore complex are actually armored. *Symbiodinium* species, although they have thin plates, also have apical grooves and are transitional between unarmored and armored.

**Ventral ridge aka ventral flange:** An identifiable ridge on the right side of the sulcal intrusion onto the epitheca that structurally has a microtubular complex.

### Armored

Armored dinokont cells, e.g., Dinophysiales, Gonyaulacales, and Peridinales, can be identified to order, family, genus, and species by a combination

of characters using (1) size, shape, and proportions; (2) cingular position, displacement, and overhang; (3) number and arrangement of plates; (4) the presence/absence of an apical pore complex and its composition; (5) the presence, size shape, location, and/or angle of lists, fins, wings, horns, spines, and ribs; (6) surface markings; and (7) the presence, size, and location of organelles. Armored species have thecal plates of varying thickness and orientation in identifiable tabulation series. Armored dinoflagellates have also been called thecate and that term has been used to distinguish between nonthecate or “naked” cells.

**Antapical plates:** Historically, those thecal plates covering the antapex of the cell. According to Balech, those plates in touch with the sulcal plates but not the cingular plates. See schematics in **Plates 24, 34, 41, and 50.**

**Apical plates:** Those thecal plates that surround and touch the apex of the cell; in those species with an APC, those plates that touch the APC. See schematics in **Plates 24, 34, 41, and 50.**

**Apical pore complex aka APC:** Many of the marine, armored dinokont-type species have an apical pore at the top of the cell. This pore is typically located in a special plate called a pore plate. The pore is not always a round or oval hole, but can be one or two slits. If the pore is a hole, then it may have a closing or cover plate or what Balech calls a canopy. The canopy appears to be the outer membrane of the thecal membrane complex and covers the pore, whereas the closing plate is a separable plate. Often the closing plate is detachable and may be missing in prepared specimens. In addition, there can be a ventral apical plate or what has been called a canal plate or an X plate. This plate is always posterior and ventral to the pore plate. See schematics in **Plates 24, 34, 41, and 50 and Plates 3–7.**

**Areolate:** In armored dinoflagellates, ornamentation on thecal plates that approximates deep or shallow depressions with or without raised sides. The sides may be polygonal or round and are closely appressed. Areolae can contain pores, even double pores. See **Plate 11, *D. acuta*, and Plate 14, *P. rotundatum*.**

**Armored aka thecate:** Armored species have thecal plates of varying thickness and orientation in identifiable tabulation series. At one time, armored dinoflagellates were also called thecate and that term was used to distinguish between armored and naked cells.

**Attachment pore:** Unarmored and armored dinoflagellates that form chains or longitudinally connected cells that swim as a chain, often have cytoplasmic contact between cells. In such cases with the armored species, an anterior attachment pore is typically located in the pore plate of the APC in addition to the apical pore. In *Alexandrium*, the attachment pore

in relation to the apical pore can be a diagnostic character. The posterior attachment pore is typically located in the posterior sulcal plate and can also be a diagnostic character. See schematic of **Plate 34**.

**Denticulate:** Thecal markings or surface ornamentations consisting of spines having a broad base which taper to a narrow point like a tooth.

**Depression aka pit:** Surface ornamentation on thecal plates. A depression typically with a rim and not appressed to another depression. Depressions can have pores. See **Fig. 11**.

**First apical plate:** The plate in armored dinokonts that is typically situated directly above the *sa* plate. In addition, it is typically directly below the APC in those species that have this feature. Some species have what is called a “displaced” first apical plate not in direct contact with the APC but connected to it by a vertical suture. The displaced 1' is directly above the *sa* plate. The 1' plate can be four to six sided and is used as a diagnostic character in *Protoperidinium*. See **Fig. 8** and **Plate 34** for schematic.

**Homologous plates:** The tabulation of plates occurs in defined series or groups. To look at relationships between species and higher ranks in the armored types, a plate in the precingular series may equate to a 1' that is displaced from the apex or a sulcal plate may equate to a postcingular. Plate overlap patterns and other patterns are being used to infer homologous structures based on form.

**Horns:** In armored species only, these prominent apical or antapical extensions of the cytoplasm are covered by thecal plates. An apical horn forms the apex of the cell and is formed by apical plates. Antapical horns are typically formed by antapical plates; however, in *Ceratium*, they are formed by both antapical and posterior intercalary plates. Therefore, in *Ceratium* they are called hypothecal horns. Horns can be hollow or portions can be solid. See **Plates 24 and 50** schematics.

**Intercalary plates:** In armored species, these plates are those located between the precingular and the apical series (anterior intercalaries) or those plates between the postcingular and the antapical series (posterior intercalaries). Anterior intercalary plates are by definition not in contact with the apex or the cingulum, and posterior intercalary plates are not in

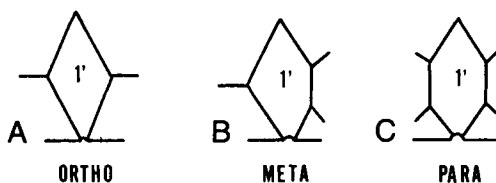

FIGURE 8 (A) Ortho; (B) meta; (C) para. Redrawn from Taylor (1980).

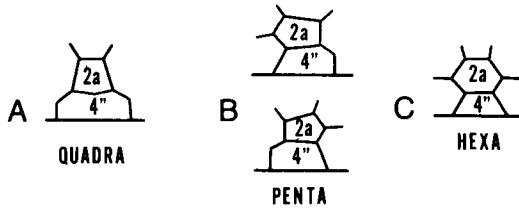

FIGURE 9 (A) Quadra; (B) penta; (C) hexa. Redrawn from Taylor (1980).

touch with the cingulum but may touch the antapical plates. The second anterior intercalary (2a) may be four to six sided, i.e., quadra, penta, or hexa, and is used as a diagnostic character in *Protoperidinium*. See Fig. 9 and Plates 41 and 50 schematics.

**List aka wing, flange:** Membranous extensions of armored dinoflagellates, e.g., cingular lists and sulcal lists that extend beyond the cell boundary. Sometimes these extensions are curved and the space created harbors pigmented symbiotic cyanobacteria. See Plate 10 schematic and Plate 13, and Plate 48, *D. lenticula*.

**Plate overlap aka imbrication:** Typically, in the Peridinales, thecal plates adjoin neighbor plates with bevelled peripheral plate edges; the angle of the bevel depends on whether the plate is the overlying or underlying plate. Plate overlap or imbrication patterns are conservative characters and are being used to infer plate homologies (Fig. 10).

**Reticulae:** Surface ornamentation on thecal plates where raised straight or irregular lines cross one another forming a network or mesh of varying shape and size. The reticulae may even be incomplete (Fig. 11).

**Ribs:** Supports for sulcal lists, e.g., in the Dinophysiales, and cingulum lists of many *Protoperidinium* species. See Plates 11–14.

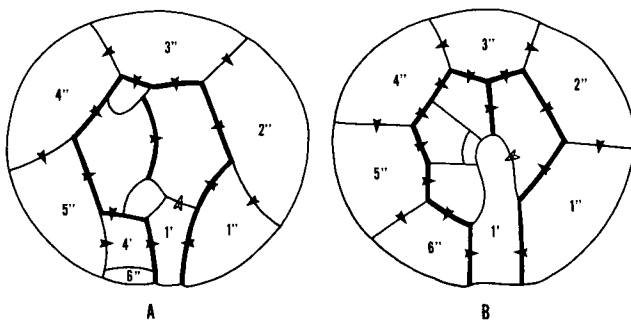
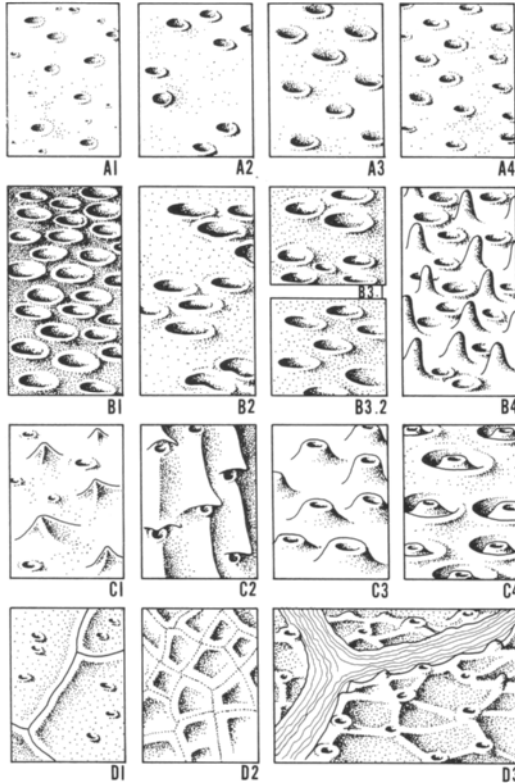

FIGURE 10 Plate overlap of gonyaulacoids with arrows showing direction of overlap. (A) Fossil genus; (B) *Lingulodinium polyedra*. Redrawn from Gocht (1981).



**FIGURE 11** (A) A1–A4 show irregularly arranged pores of the same or varying size; (B) B1–B4 show depressions and pores and depressions and spines; (C) C1–C4 show pores associated with variously shaped reliefs; (D) D1–D3 show different combinations of reticular reliefs and simple pores. Redrawn from Andreis et al. (1982).

**Spines:** Solid protuberances on the thecal plates that usually taper to a point; they can be short or long or broad or narrow.

**Striae:** Surface ornamentation on unarmored or armored dinoflagellates that appear as longitudinal lines or ridges; on armored species the striae can be interrupted by pores and may be associated with other markings such as reticulations. See **Plate 20**, *Gyrodinium spirale*, and **Plate 42**, *Gonyaulax fragilis*.

**Sutures:** In armored species, visible linear boundaries between plates that usually indicate the end of one plate and the beginning of another. In many species, the substance that holds plates together is susceptible to chemical agents, such as Chlorox, and plates can be physically separated by using such chemicals. In light microscopy, sutures typically appear as

lines between plates that can be enhanced by stains due to either the higher amount of polysaccharides or some compound associated with the binding of plates.

**Tabulation aka plate formula:** Plate patterns of armored dinoflagellates reflect orientation, e.g., the Procoentrales versus the Dinophysiales versus the Peridiniales, as well as which plates are adjoining one another or what type ornamentation they produce. Tabulation refers to counting the plates in a specific designated series. In the Kofoidian System of plate nomenclature, there are six major transverse series: apical ('), anterior intercalary (a), precingular ("), postcingular (""), posterior intercalary (p), and antapical ("""). Each defined plate series has a superscript designation or a letter. For example, 3' means that there are three apical (') plates. At the time Kofoid (1907, 1909, 1911) proposed his system, cingular and sulcal plates were not studied nor were apical pore complexes. More recently, cingular (c) and sulcal (s) plate series have been added to the plate formula as well as components of the APC, i.e., Po, cp, and X, if they occur. The plate formula is the combined tabulations for the plate series, e.g., Po, 4', 0a, 6", 8c, 5s, 5"", 1p, 3""". In 1980, Balech suggested a clarification for the antapical and posterior intercalary series that involves positioning of plates in relation to the sulcus. He defined antapical as “. . . those plates which border the sulcus without being connected with the cingulum” and posterior intercalary as “. . . touches neither the cingulum nor the sulcus.” Balech’s modification of the Kofoidian scheme is used in Table 1 and in the species descriptions. A plate formula is generally stable within a genus, yet a range in number for a specific series can occur due to splitting of plates or other factors. Older species descriptions typically do not include the sulcal and cingular plates. There are other tabulation schemes, e.g., Eaton (1980) and Taylor-Evitt in Evitt (1985). Eaton’s is the simplest with three series in the epitheca and three series in the hypotheca: precingular (plates touch cingulum), apical (plates touch precingulars), apical closing (plates anterior to apicals), postcingular (plates touch cingulum), antapical (plates touch antapex), and antapical closing (plates posterior to antapicals). Intercalaries do not exist in Eaton’s scheme, but cingulars and sulcals are counted.

**Transitional plate—t:** A small plate located in the cingulum–sulcus juncture. If the t plate is on the left side of the cell in the cingulum, it is really the first cingular plate and is counted as such. Occasionally, you will see cingular tabulations that read 3 + 1t, the tabulation should read 4c. If the t plate is on the right side of the cell at the cingulum–sulcus juncture, it is a sulcal plate and is so tabulated (Fig. 12).

**Ventral pore:** In some gonyaulacoids, a ventral pore may be present at the juncture of the first apical plate (1') and an anterior intercalary or

another apical plate. Sometimes the pore is in one of the apical plates or an intercalary. The presence of a ventral pore or its placement may be diagnostic for certain species, also in the epitheca of dinophysoids. See **Plate 34** schematic.

**Vermiculate:** Plate ornamentation patterns in armored species that are raised worm-like markings. Markings such as reticulae, areolae, vermiculae, etc., may not be visible on newly formed thecae because they are among the last thecal ornamentation characters to be formed.

**“x” Plate:** In *Crypthecodinium* and *Hemidinium* the distal end of the cingulum does not meet the proximal end, it ends on the right ventral surface. In *Crypthecodinium*, the plate that occupies what would be a cingular plate (and a postcingular) in other armored dinokonts is called an X plate. See **Plate 34**, *C. cohnii*.

### Life Cycles

**Life cycle:** A continuum of phases and cell types in the reproduction and growth of a species. The life cycle usually contains at least an asexual phase in which a cell can divide by binary fission and produce two similar cells. It may also contain a sexual phase in which gametes fuse to form zygotes (2N) and these zygotes produce 1N cells (**Fig. 13**).

**Archeopyle:** This is the area of a cyst where the cell will emerge during excystment. If the cyst does not split or separate at the cingulum, it usually will have an archeopyle and an operculum associated with the escapement hole; the operculum may even be hinged. See **Plate 51**, cysts.

**Asexual:** Reproduction where a 1N cell produces two to four cells with the same chromosome number. This can be by binary fission of a motile stage or a nonmotile stage. In many armored dinokonts, the original cell splits along predetermined sutures and then each half produces a new half with new thin plates (**Figs. 14 and 15**).

**Cocoid:** Nonmotile stages of the life cycle, usually referring to vegetative phase cells that dominate the life cycle and can be thick walled.

**Diploid:** A cell (zygote) that has a nucleus with two sets of chromosomes (2N).

**Ecdysis:** The process of shedding or casting off the thecal plates or armor whereby one of the internal membranes, the innermost membrane, becomes the new outer membrane. When the induction of ecdysis is due to stress and the stress is removed, the spheroplast can regenerate a new theca. Not all ecdysis is due to stress, it can be involved in fusion of armored gametes or other reproductive processes like cell division.

**Encystment:** There are several types of encystment. Stressed cells can “round up” and settle out of the water column and yet be viable if the



TABLE 1 Kofoidian Plate Formulae for Selected Armored Dinoflagellate Genera

Genus	Po	cp	X	'	a	"	c	s	'''	p	'''	Text location
<i>Centrodinium</i> Kofoid	+	0	0	2	3	7	5	?	5	0	2	p. 516
<i>Corythodinium</i> Loeblich Jr. & Loeblich III	+	0	0	3	2	6	5	4?	5	0	1	pp. 516–517; Plates 7a and 45
<i>Oxytoxum</i> Stein	+	0	0	5	0	6	5	4	5	0	1	pp. 517–519; Plates 7a and 45
<i>Amphidiniopsis</i> Woloszynska	+	0	0	4	1–3	5–6	3?	?	5	0	2	p. 546
<i>Roscoffia</i> Balech	+	0	0	4	0	5	3	3	5	0	1	pp. 546–547
<i>Adenoides</i> Balech	+	0	0	3	0	5	5	6	5	4	2	p. 550
<i>Thecadinium</i> Kofoid & Skogsberg	+	0	0	3	1	4	5?	5	3	0	1	p. 547; Plate 55
<i>Cladopyxis</i> Stein	+	0	0	3	3	7	6	7	6	0	2	p. 487
<i>Paleophalacroma</i> Schiller	+	0	0	4	3	7	6	6	6	0	2	p. 487; Plate 7c
<i>Coolia</i> Schmidt	+	0	0	3(4)	0	7(6)	6	6?	5	1	2	pp. 513 and 515; Plates 5d and 44
<i>Ostreopsis</i> Munier	+	0	0	3(4)	0	7(6)	6	6?	5	1	2	p. 515; Plates 5c, 5f, and 44
<i>Amphidoma</i> Stein	+	0	0?	6	0?	6	6	4?	6	0	2	p. 504; Plate 41
<i>Gambierdiscus</i> Adachi & Fukuyo	+	0	0	4	0	6	6	8	6	0	2	p. 501; Plate 5a
<i>Amylax</i> Munier	+	0?	0	3	3	6	6	7–8	6	0	2	p. 504; Plate 41
<i>Ceratocorys</i> Stein	+	0?	0	3	1	5	6	10	5	0	1	p. 482; Plates 3g and 30
<i>Ceratium</i> Schrank	+	0?	0	4	0	6	5–6	2+	6	0	2	pp. 470–482; Plates 6 and 24–33
<i>Gonyaulax</i> Diesing	+	0?	0	3	2	6	6	7	6	0	2	pp. 506–507; Plates 4e, 41 and 42
<i>Lingulodinium</i> (Stein) Dodge	+	0?	0	3	3	6	6	7	6	0	2	pp. 509–510; Plates 4f and 43
<i>Schuetziella</i> Balech	+	0?	0	2	1	6	6	9	6	0	2	p. 512; Plate 43
<i>Spiraulax</i> Kofoid	+	0?	0	3	2	6	6	7	6	0	2	p. 512
<i>Fragilidium</i> Balech ex Loeblich III	+	+	0	4–5	0	7–9	9–11	6–8	7–8	1	2	pp. 520–521; Plate 4b

<i>Pyrophacus</i> Stein	+	+	0	5-9	0-8	7-15	9-16	8	8-17	0-15	3	p. 523; Plates 5b, 5e, and 46
<i>Alexandrium</i> Halim	+	+	0	4	0	6	6	9-10	5	0	2	pp. 488-500; Plates 3 and 34-39
<i>Goniodoma</i> Stein	+	+	0	4	0	6	6	6	6	0	2	p. 501; Plates 3f and 40
<i>Heterodinium</i> Kofoid	+	+	0	3	2	6	6	?	6	0	3	p. 513; Plate 44
<i>Protoceratium</i> Bergh	+	+	0	3	0	6	6	6	6	0	2	pp. 419-426; Plates 8 and 9
<i>Pyrocystis</i> Murray ex Haeckel	+	+	0	4	0	6	6	5-7	5	0	2	pp. 519-520; Plate 45
<i>Pyrodinium</i> Plate	+	+	0	4-5	0	6	6	6	6	0	2	p. 503; Plates 4 and 40
"Phantom"	+	+	+	4	1	5	6	4	5	0	2	p. 550; Plate 55
<i>Peridiniella</i> Kofoid & Michener ex Balech	+	0	+	4	3-4	7	6	6-7	6	0	2	p. 510; Plate 43
<i>Ensiculifera</i> Balech	+	0	+	4	3	7	5	5	5	0	2	pp. 523-524; Plate 47
<i>Pentapharsodinium</i> Indelicato & Loeblich III	+	0	+	4	3?	7	5	4	5	0	2	pp. 524-526; Plate 47
<i>Scripsiella</i> Balech ex Loeblich III	+	0	+	4	3	7	6	4-5	5	0	2	pp. 525-527; Plates 6 and 47
<i>Boreadinium</i> Dodge & Hermes	+	0	+	4	1	7	4	5	5	0	1	p. 527
<i>Diplopelta</i> Stein ex Jørgensen	+	0	+	4	1	6	4	6	5	0	2	pp. 527-529; Plates 6 and 48e
<i>Diplopsalis</i> Bergh	+	0	+	3	1	6	4	5	5	0	1	p. 529; Plate 48a
<i>Diplopsalopsis</i> Meunier	+	0	+	4	1	7	4	6	5	0	2	p. 529; Plate 48f
<i>Oblea</i> Balech ex Loeblich, Jr., & Loeblich III	+	0	+	3	1	6	4	6	5	0	2	pp. 529-530; Plate 48g
<i>Preperidinium</i> Mangin	+	0	+	4	1	7	4	5	5	0	1	p. 530; Plate 48b
<i>Protoperidinium</i> Bergh	+	0	+	4	2-3	7	4	6	5	0	2	pp. 534-546; Plates 6d and 50-54
<i>Heterocapsa</i> Stein	+	+	+	6	3	7	6	5	5	0-1	2	pp. 530-531; Plates 6b, 6c, and 49
<i>Crypthecodinium</i> Biecheler	0	0	0	4	3	5 + x	6	5	5	0	3	pp. 516-518
<i>Gotius</i> Abé	0	0	0	4	1	6	4	5	5	0	2	p. 529; Plate 48

(continues)

TABLE 1 (Continued)

Genus	Po	cp	X	'	a	"	c	s	"	p	"	Text location
<i>Peridinium</i> Ehrenberg	0/+	0	0/+	4	3	7	5-6	5-6	5	0	2	p. 539
<i>Blepharocysta</i> Ehrenberg (no cingulum)	+	+	+	3	1	5	3	4	4-5	0	1	p. 533; Plates 7d and 49
<i>Lissodinium</i> Matzenguer emend. Carbonell-Moore (no cingulum)	+	+	+	3	1	5	3	5	5	0	1	p. 533; Plates 7e and 49
<i>Podolampas</i> Stein (no cingulum)	+	+	+	3	1	5	3	5	5	0	1	p. 534
Selected Armored Dinoflagellate Genera without Kofoidian Plate Formulae												
	Plate descriptions											Text location
<i>Prorocentrum</i> Ehrenberg	Left and right valves; 5-14 periflagellar pore plates; no kofoidian series											pp. 419-426; Plates 8 and 9
<i>Dinophysis</i> Ehrenberg	All Dinophysiales have a similar plate formula of 18 or 19 Plates; 4E 2A 4C											pp. 428-434; Plates 11-17
<i>Phalacroma</i> Jørgensen	4-5S 4H											pp. 437-439; Plates 14-16
<i>Ornithocercus</i> Stein												pp. 436-437; Plates 13 and 16
<i>Histioneis</i> Stein												p. 434; Plate 13
<i>Amphisolenia</i> Stein												pp. 426-428; Plate 10

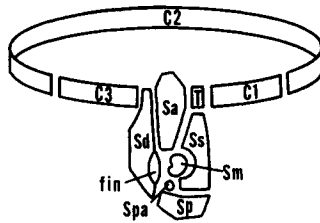

FIGURE 12 The “r” plate is on the left side of the cell and is therefore a cingular plate, c1. Redrawn from Taylor (1980).

conditions of stress are removed. Others involve temporary cysts for asexual reproduction, flotation, and other functional aspects of individual survival. Yet another type of encystment involves sexual reproduction and the production of thick-walled hypnozygotes which can remain encysted for months, even years. These resting cysts or hypnozygotes have their own classification system, distinguishing morphological characters, and applied terminology (see Fig. 13).

**Excystment:** When the hypnozygote matures and is ready to produce a motile cell from the resting cell, a naked meiocyte will emerge from the archeopyle or opening in the wall. This emerging cell will either be flagellated or amoeboid. Typically, this cell will undergo meiosis and produce four vegetative 1N cells that are motile in the water column (see Fig. 13).

**Gametes:** In armored and unarmored species a 1N cell that fuses with another 1N cell to produce a zygote (2N). Gametes can be like-sized cells and morphologically similar cells (isogametes) or unlike-sized cells and morphologically similar (anisogametes) (Fig. 16).

**Haplont:** Vegetative or gametic cells that have one set of chromosomes. Dinoflagellates are haplonts meaning that their dominant stage is haploid (1N) and their zygotic sexual stages are diploid (2N), with the exception of *Noctiluca*.

**Hypnozygote aka dinocyst:** This is a diploid zygotic stage in the sexual life cycle of dinoflagellates. All but one dinoflagellate species is a haplont with the planozygote and hypnozygote being the only 2N stage. Dinoflagellates with a hypnozygote are typically dimorphic in that the 1N and 2N zygote stages are morphologically dissimilar. The hypnozygote is a resting, nonmotile stage that settles to the sea bottom and may be dormant for some time depending on entrainment of internal biological clocks or other triggering mechanisms. It is not known whether all dinocysts are zygotes (see Fig. 13).

**Planozygote:** A motile zygote (2N) cell produced by the fusion of (1N) gametes. Typically, the planozygote is morphologically similar to the vegetative (1N) cell (see Fig. 13).

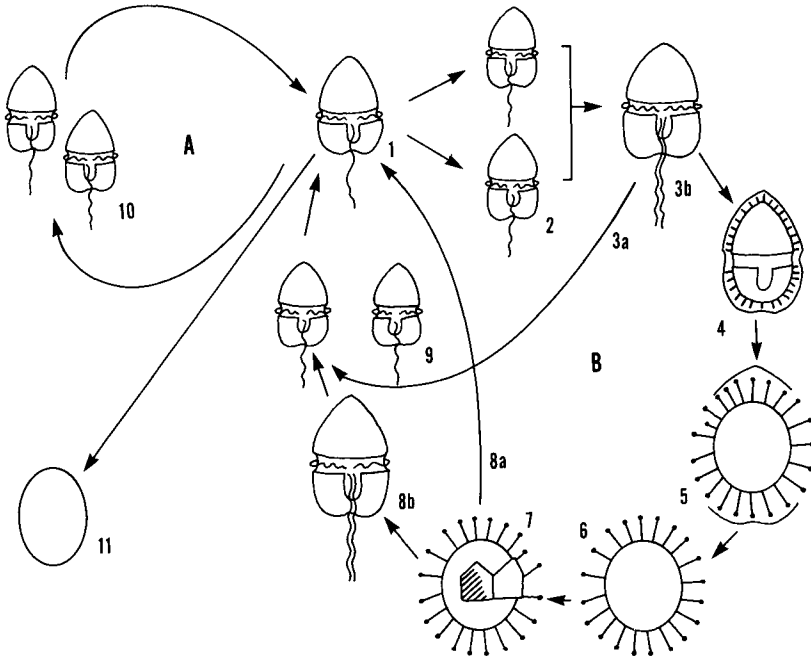

**FIGURE 13** General life cycle of a hypnozygote-producing dinoflagellate. (A) Asexual phase with motile, planktonic vegetative cell (1) which divides by binary fission (10) and sometimes forms nonmotile temporary cysts (11); (B) Sexual phase with motile, planktonic vegetative cell (1) which produces gamete pairs (2) that fuse to form a planozygote (3). The planozygote can produce motile, planktonic vegetative cells (9) by meiosis (3a) or cyst formation (4) may occur and proceed (5) by expansion of the cyst to form a resting cyst (hypnozygote) (6). Excystment (7) can produce a planozygote (8b) which continues to divide to produce a motile vegetative cell (1) or division can take place completely during excystment (8a) to produce a motile vegetative cell (1) directly. Redrawn from Dale (1986).

**Sexual:** Sexual reproduction involves the production of gametes that fuse to produce a zygote. Sexual reproduction has been documented in the laboratory for >30 species where most produce hypnozygotes. Some only produce planozygotes and it is not known whether the planozygote stage is a “resting stage” or if the conditions for hypnozygote formation were not simulated.

## IDENTIFICATION OF SPECIES

The following dinoflagellate species descriptions are presented by order then alphabetically by family. Planktonic and benthic species are detailed to

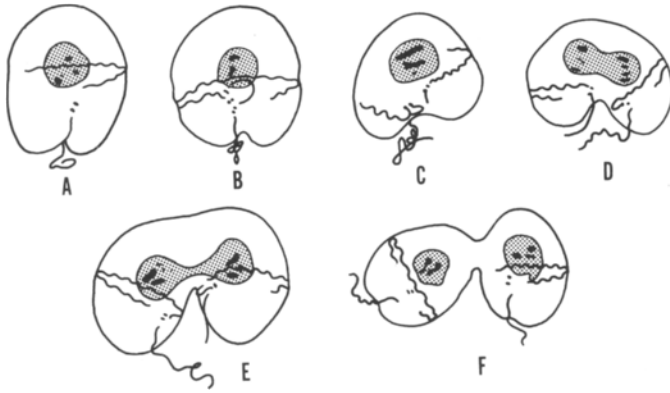

FIGURE 14 Asexual division of *Gyrodinium uncatenum* with typical mitotic phases. Redrawn from Coats (1984).

provide the reader with the diversity of morphological characters that are needed to differentiate between genera or species. Many benthic species are tychoplanktonic and found at some time in the water column. Also, many

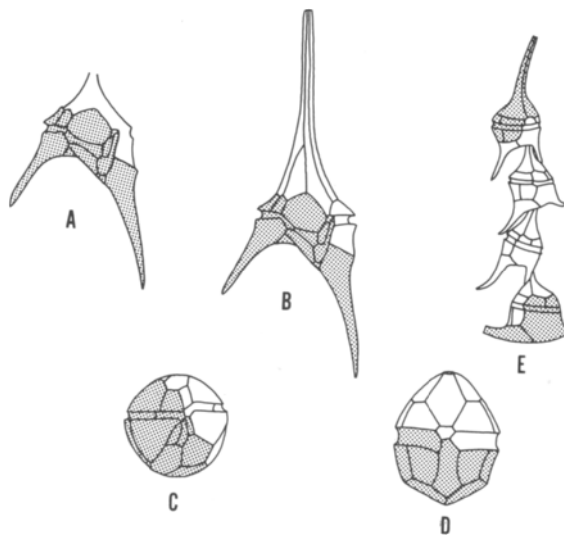

FIGURE 15 In asexual division of armored species, division can occur along predetermined lines creating daughter cells with specific plate series; shaded areas indicate the portion inherited from the parent cell. (A) Indistinct tabulation of apical horn of young freshwater *Ceratium furcoides*; (B) apical horn tabulation evident on older cell of the same *Ceratium*; (C) *Goniodoma sphericum*; (D) freshwater *Peridinium lubiensiforme*; (E) *Ceratium* gametes. Redrawn from Evitt (1985).

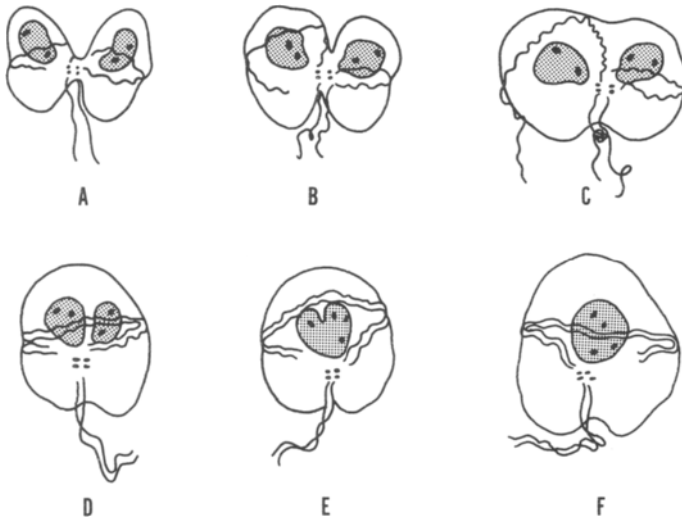

FIGURE 16 Gamete fusion in *Gyrodinium uncatenum*. (A) Like gametes (isogametes) fuse until the nuclei fuse (E) and produce a planozygote (F). The planozygote will form a hypnozygote that is round and thick walled. Redrawn from Coats et al. (1984).

benthic species are known to be toxic, particularly the tropical and subtropical representatives. Size is often a relative variable and in these species descriptions small =  $<50 \mu\text{m}$ , medium =  $50\text{--}100 \mu\text{m}$ , and large =  $>100 \mu\text{m}$ . These are approximate scales. Of the 246 species described, 214 are illustrated in plates.

#### Order Prorocentrales Lemmermann 1910

References: Schiller, 1933; Dodge, 1982; Loeblich III, 1982; Sournia, 1986; Fensome et al., 1993.

Armored, bivalvate cells with desmokont flagellar insertion. Anterior periflagellar area; no cingulum nor sulcus.

#### Family Prorocentraceae Stein 1883

Genus *Mesoporos* Lillick 1937 (<10 spp.)

Synonyms: *Porella* Schiller 1928; *Dinoporella* Halim 1960; *Porothea* Silva 1960.

Type: *M. globulus* (Schiller) Lillick 1937.

References: Schiller, 1933; Dodge, 1982; Sournia, 1986; Subrahmanyam, 1966.

Armored, small round to ovoid cells somewhat compressed laterally. Bivalvate; similar to *Prorocentrum* but with a large central cone-shaped pore in each valve. Surface markings present. Chloroplast(s) present.

**Remarks:** Resolution of the periflagellar area may help further separate this genus from *Prorocentrum*.

*Mesoporos perforatus* (Gran) Lillick 1937 (not illustrated)

Surface covered with small pyramid-shaped papillae; area around the central pore in both valves is clear of papillae.

**Distribution:** Neritic to oceanic; cold temperate to tropical waters.

**Genus *Prorocentrum*** Ehrenberg 1833 (<50 spp.)

**Synonym:** *Exuviaella* Cienkowski 1881.

**Type:** *P. micans* Ehrenberg 1833.

**References:** Abé, 1967a; Bursa, 1959; Dodge, 1975; Faust, 1974, 1990a,b, 1991, 1993a,c, 1994; Honsell & Talarico, 1985; Hulburt, 1965; Loeblich et al., 1979; Norris and Berner, 1970; Schiller, 1933; Steidinger, 1983; Steidinger & Williams, 1970; Tafall, 1942; von Stosch, 1980:

Armored. Small to medium-sized cells that vary from spheroid to pyriform in valve view. Cells with chloroplasts. Valves can be convex to concave in lateral view. Cell with two anterior dissimilar flagella. In some, both emerge out of one flagellar pore. The second pore between periflagellar plates may be associated with mucoid production and attachment. In others, flagella emerge from two separate pores. Some species with anterior winged spines, termed "tooth," or anterior short projections. Surface markings vary from pores to areolae to spines. Internally, many *Prorocentrum* have a central pyrenoid, a posterior nucleus, and anterior vacuoles. Two opposing valves, one designated left and the other right. Small periflagellar plates (5–14) indent the anterior margin of the right valve; 8 most common.

**Remarks:** Surface markings in conjunction with shape and size and indentation of the right valve are conservative and diagnostic characters that can be used to separate species when cells are not too aged. If the outer membrane is still attached to scanning electron microscopy (SEM) prepared specimens, however, it can obscure surface features such as pores. Older cells often have megacytic zones, altered outlines, and muted surface features due to additional polysaccharide deposition. As with the gonyaulacoids, the first thecal markings to appear are sutures separating plates and valves, then pores, then reticulations or areolations. Von Stosch (1980), like Dodge (1983), considered the Prorocentraceae evolutionarily advanced and originating from plate reduction. This hypothesis was advanced based on the periflagellar plates and similarities with the Dinophysiales which were thought to be ancestral. Other dinoflagellate workers, e.g., Loeblich III (1976) and F. J. R. Taylor (1980), present the Prorocentraceae as primitive and ancestral. Species of this genus are differentiated based on the following characters: size and shape, the presence of apical processes, shape of periflagellar area, number and pattern



of periflagellar plates, number and size of aerolae or poroids, pore pattern, and markings on intercalary bands.

**Distribution:** Species can be planktonic or benthic/epiphytic (tychoplanktonic); if the latter they can attach to a substratum via a mucoid holdfast or thread. Many plankton species are bloom species and many benthic species are toxic and can reach high cell densities/cm<sup>2</sup>.

***Prorocentrum arcuatum*** Issel 1928 (Plate 8)

Medium-sized, lanceolate cell that is broadest above the median point. Posterior portion attenuated and sometimes twisted. Cell with a long anterior spine that is broad at the base. Surface reported with shallow depressions.

**Distribution:** Planktonic. Warm temperate and tropical waters.

***Prorocentrum balticum*** (Lohmann) Loeblich III 1970 (Plate 9)

Small, <20  $\mu\text{m}$  round to ovoid cell in valve view. In side view, round and not flattened. Periflagellar area bordered by two apical projections. Valves covered with many interconnected spines; pores appear rimmed and scattered.

**Remarks:** Surface pattern as illustrated by Dodge (1985) is different than any form found in the *minimum* complex. Because of its small size, records of *P. balticum* may actually include closely related, but undescribed species, as could *P. minimum*. Toxic?

**Distribution:** Planktonic. Neritic; worldwide distribution.

***Prorocentrum belizeanum*** Faust (Plate 9)

Medium-sized, round to broadly oval cell with about an average of 950 areolae on each valve. Areolae are <1  $\mu\text{m}$  in diameter. Valves with pores but not in center. Raised anterior ridge on left valve as in *P. hoffmannianum*. Toxic.

**Remarks:** This species can easily be confused with *P. concavum* and *P. hoffmannianum*. It differs from *P. concavum* by having prominent areolae in the center of both valves. These areolae can fill in with age. It differs from *P. hoffmannianum* by having a periflagellar area similar to *P. lima* and smaller but more thecal areolae.

**Distribution:** Benthic. Tropical coastal waters; recently described.

***Prorocentrum compressum*** (Bailey) Abé ex Dodge 1975 (Plate 9)

Small to medium-sized, broadly ovate cell in valve view; compressed in side view. Characteristic anterior feature of what appear to be two opposed short spines bordering the periflagellar area. Valves covered with pores and shallow depressions. Ornamentation more developed centrally.

**Remarks:** The anterior projections are extensions of the periflagellar plates, like collars.

Prorocentrum

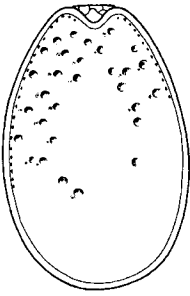

*P. lima*

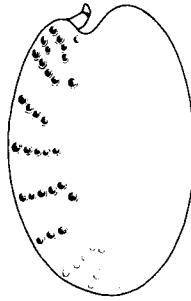

*P. mexicanum*

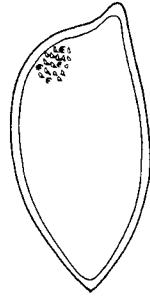

*P. dentatum*

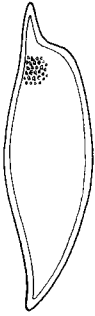

*P. rostratum*

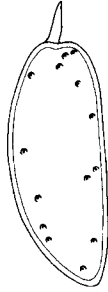

*P. triestinum*

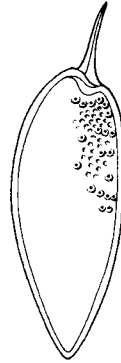

*P. gracile*

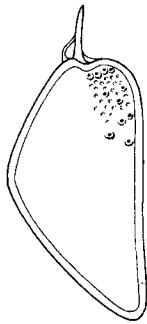

*P. arcuatum*

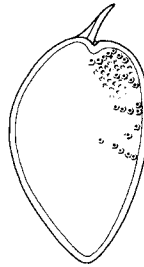

*P. micans*

PLATE 8 *Prorocentrum lima*, *P. mexicanum*, *P. dentatum*, *P. rostratum*, *P. triestinum*, *P. gracile*, *P. arcuatum*, and *P. micans*. Scale = 10  $\mu$ m.

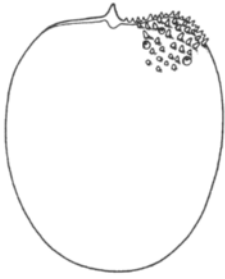

*P. minimum*

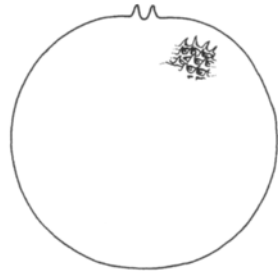

*P. balticum*

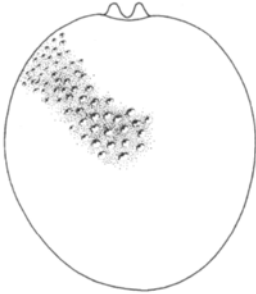

*P. compressum*

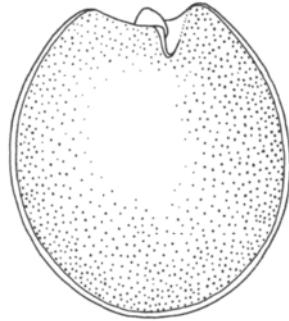

*P. emarginatum*

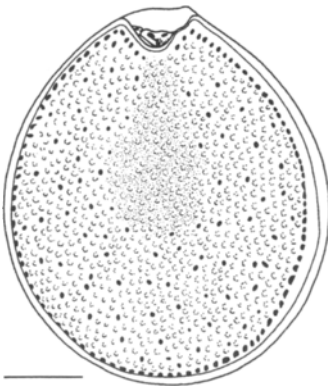

*P. belizeanum*

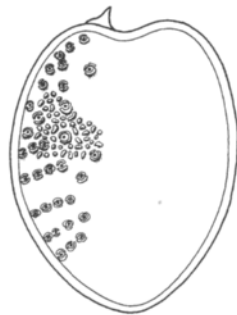

*P. scutellum*

**PLATE 9** *Prorocentrum minimum*, *P. balticum*, *P. compressum*, *P. emarginatum*, *P. belizeanum*, and *P. scutellum*. Scale = 10  $\mu\text{m}$ .

**Distribution:** Mostly planktonic. Neritic, oceanic; cosmopolitan in cold temperate to tropical waters.

***Prorocentrum concavum*** Fukuyo 1981 (not illustrated)

Medium-sized, broadly ovoid cell with prominent surface areolae. Valves with scattered pores in areolae. The anterior periflagellar area is a narrow V-shaped indentation of the right valve composed of eight platelets and two pores. The left valve is slightly indented as well. Both valves are centrally devoid of areolae. Toxic.

**Remarks:** This species is very closely related to *P. hoffmannianum* Faust, which has less areolae (about 700 per valve), and *P. belizeanum* (about 950 areolae per valve). The shallow areolae in the central portion can be obscured in older cells.

**Distribution:** Benthic; can be tychoplanktonic. Tropical and neritic waters.

***Prorocentrum dentatum*** Stein 1883 (Plate 8)

Small to medium-sized, broadly oblong cell that is attenuated posteriorly. In valve view, sides mostly straight from anterior to median point. Anterior with shoulder. Valves covered with almost evenly spaced, broad-based spines.

**Distribution:** Planktonic. Oceanic; cold temperate to warm temperate waters; worldwide.

***Prorocentrum emarginatum*** Fukuyo 1981 (Plate 9)

Small oval cell with anterior margin broadly excavated in valve view. The right valve contains the periflagellar plates which fill a cuneiform indentation that curves at the distal end. A short, angled flange at one side of the periflagellar area appears as a thick, winged spine. In young cells there are small pores and the pores that are postmedian are arranged radially. In older cells, the pore pattern can be obscured by depressions that contain pores but the radial pattern is not obvious. Young valves smooth, but older valves can have poroids and pustules. No prominent marginal pore series.

**Remarks:** This is another case in which field specimens can be misidentified because of differences between young and old cells and the effects of aging on surface markings. In culture the aging process can be followed within a population.

**Distribution:** Benthic; can be tychoplanktonic. Warm temperate to tropical coastal waters.

***Prorocentrum gracile*** Schütt 1895 (Plate 8)

**Synonym:** *P. hentschellii* Schiller 1933.

Small to medium-sized, elongate *P. micans*-like cell that is more than twice as long as broad. Pyriform rather than heart shaped with pointed

posterior end in valve view. Valves with shallow poroids and postmedian radial pore fields as in *P. micans*. Long, winged anterior spine adjacent to periflagellar area.

**Remarks:** This species has been misidentified frequently as *P. micans*, *P. hentschelii*, *P. redfeldii*, or *P. rostratum*.

**Distribution:** Principally neritic and estuarine; cosmopolitan in cold temperate to tropical waters.

***Prorocentrum lima*** (Ehrenberg) Dodge 1975 (Plate 8)

Small to medium-sized obovate cell that is broadest postmedian. Cell with a central pyrenoid and a posterior nucleus. Periflagellar area with eight plates; anterior flange attached to plate. Each valve with about 50–80 marginal pores and about 60–100 evenly spaced pores on the valve surface. In older cells, surface can become vermiculate. Both valves are anteriorly indented, but the right valve has a shallow V-shaped or triangular excavation with the protruding flange. Toxic.

**Remarks:** This species can be confused with a variety of similar *Prorocentrum* with a triangular periflagellar area and oval or ovoid shape. For example, it can be confused with *P. concavum* at the light microscope level unless the edge effect or marginal pore effect is studied. It also can be confused with *P. maculosum* which has marginal pores and scattered depressions.

**Distribution:** Neritic and estuarine. Benthic/epiphytic; can be tychoplanktonic. Worldwide distribution.

***Prorocentrum mexicanum*** Tafall 1942 (Plate 8)

**Synonyms:** *P. maximum* Schiller 1937; *P. rhathymum* Loeblich, Sherley, & Schmidt 1979.

Small oval cell with delicate appearance including very lightly pigmented, stranded cytoplasm. Nucleus typically postmedian, but not posterior. Periflagellar area with well developed winged spine. Postmedian trichocyst pores are radially arranged in deep, round to oval depressions that create diagonal furrows. These radiating rows of pores can appear as spines at the light microscope level. The pores can appear hooded or collared.

Toxic.

**Remarks:** As with other *Prorocentrum*, surface features can change with age.

**Distribution:** Neritic and estuarine. Benthic; can be tychoplanktonic. Tropical and subtropical waters.

***Prorocentrum micans*** Ehrenberg 1833 (Plate 8)

Medium-sized, pyriform to heart-shaped cell. Typically, in valve view, cell will have one convex side and one arched side. The convex arch profile is typically in the middle of the cell. In lateral view, the cell is flattened.

Valves with shallow depressions and postmedian radial pore fields as in some other *Prorocentrum* species.

**Remarks:** One of the most common and variant species in the genus tolerating salinities above 90‰ in salt lagoons in Caribbean islands.

**Distribution:** Planktonic; neritic and estuarine, but found in oceanic environments. Cosmopolitan in cold temperate to tropical waters.

***Prorocentrum minimum*** (Pavillard) Schiller 1933 (Plate 9)

**Synonyms:** *P. mariae-lebourae* (Parke & Ballantine, 1957) Loeblich III 1970; *P. triangulatum* Martin 1929.

Small oval to triangular-shaped cell in valve view; flattened in side view.

Short apical spine sometimes observable. Valves with short, evenly shaped broad-based spines that can appear as rounded papillae depending on angle of view. Two sized pores present; smaller pores scattered. Larger pores at bases of some peripheral spines; pores appear hooded. Toxic.

**Remarks:** This species has been confused with *P. balticum* but it is larger with a different shape and surface markings. Both species bloom.

**Distribution:** Planktonic. Mostly estuarine but also neritic. Cosmopolitan in cold temperate to tropical waters. Toxic; has caused shellfish poisoning and fish kills.

***Prorocentrum rostratum*** Stein 1883 (Plate 8)

Medium-sized cell, five or six times as long as broad. Elongate, sometimes curved profile in valve view with an anterior broad rostrum that is part of the valve and not the periflagellar area. Posterior end pointed. Valve surface with shallow depressions and probably pores.

**Remarks:** Sometimes confused with a species that has an apical spine, e.g., *P. gracile*.

**Distribution:** Planktonic. Warm water neritic species; worldwide distribution.

***Prorocentrum sabulosum*** Faust 1994 (not illustrated)

Medium-sized oval cell with about an average of 390 areolae ( $>1 \mu\text{m}$ ) on each valve. Trichocyst pores oblong and located in some of the areolae.

Triangular periflagellar area with flared apical collar.

**Remarks:** Can easily be confused with *P. hoffmannianum*, but differs in number of areolae and in configuration and structure of periflagellar plates.

**Distribution:** Benthic, tychoplanktonic. Known from type locality, Belize.

***Prorocentrum scutellum*** Schröder 1900 (Plate 9)

Small to medium-sized cell. Rounded, heart-shaped species with unique valve markings composed of radial pore fields where each pore is partially circled by raised markings. In between the pores are irregular markings that look like wax droppings. Broadly curved, winged anterior spine part of periflagellar area.

**Distribution:** Neritic or estuarine; Arctic to tropical waters.

***Prorocentrum triestinum* Schiller 1918 (Plate 8)**

**Synonym:** *P. redfeldii* Bursa 1959.

Small posteriorly pointed cell resembling a thin, narrow *P. micans*; usually <30  $\mu\text{m}$  in length. Depressions few and mainly peripherally located. Cell with a thin anterior spine.

**Distribution:** Oceanic and neritic; worldwide distribution.

**Order Dinophysiales Lindemann 1928**

**References:** Schiller, 1933; Tai & Skogsberg, 1934; Loeblich III, 1982; Sournia, 1986; Fensome et al., 1993.

Laterally flattened cells with a dinokont flagellar orientation and a premedian cingulum. Cingulum and sulcus often with wide lists supported by ribs. A total of 18 or 19 plates in apical (A), epithecal (E), cingular (C), sulcal (S), and hypothecal (H) series. Artificially includes Citharistaceae.

**Remarks:** The three families of this order discussed here are Amphisoleniaceae Lindemann, Dinophysiaceae Stein, and Oxyphysiaceae Sournia.

**Family Amphisoleniaceae Lindemann 1928**

**Genus *Amphisolenia* Stein 1883 (<50 spp.)**

**Type:** *A. globifera* Stein 1883.

**References:** Abé, 1967c; Balech, 1980, 1988a; Kofoid & Skogsberg, 1928; Schiller, 1933; Sournia, 1986; F. J. R. Taylor, 1976.

Armored. Large, fusiform cells up to >1 mm in length. Cells have often been interpreted as stick figures with a head, neck, shoulder, narrow body sometimes with an inflated midregion, and a foot. Portion of plate surfaces covered with pores. Chloroplasts present; sometimes external cyanobacteria symbionts in the cingular area. The "head" is composed of the epitheca and cingulum and species of the genus have the representative 18 plates: 4E, 2A, 4C, 4S, and 4H. The neck and shoulder have the sulcal plates and lists; Sa and Sd are elongate plates. Cingulum circular.

**Remarks:** This genus is distinctive and not easily confused with any other dinoflagellate form. As in the photosynthetic *Dinophysis*, the chloroplasts of *Amphisolenia* probably originated by serial endosymbiosis of other microalgae.

***Amphisolenia bidentata* Schröder 1900 (Plate 10)**

Between 500 and 1000  $\mu\text{m}$  with a prominent spined heel and two front spines on the foot. Posterior part of cell with foot slightly curved.

**Distribution:** Oceanic, sometimes associated with upwelling; cosmopolitan in warm temperate to tropical waters.

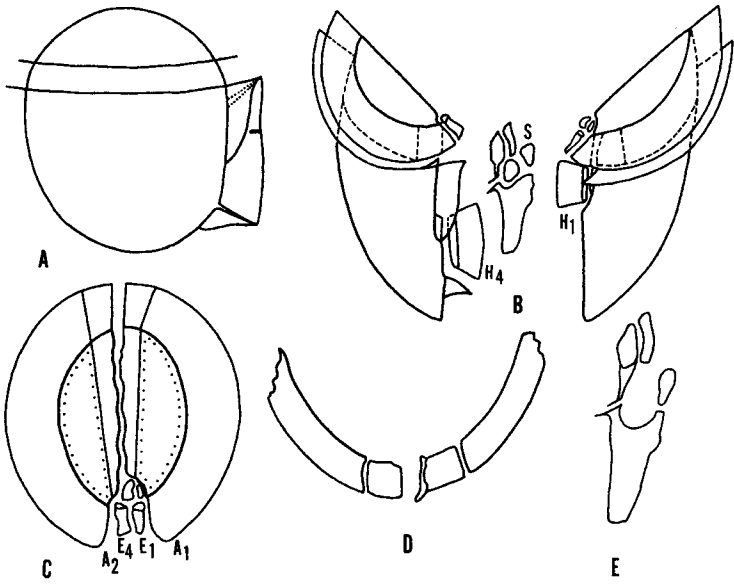
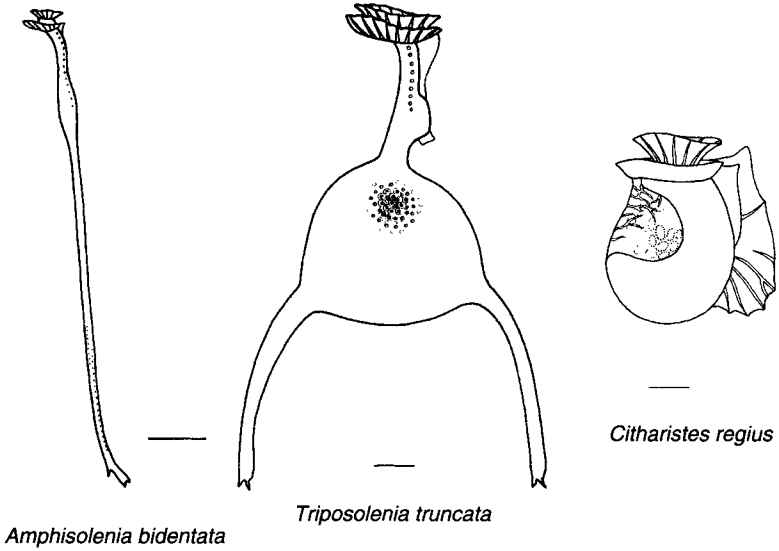

schematic Dinophysoid

PLATE 10 *Amphisolenia bidentata* (scale = 100 μm). *Triposolenia truncata* and *Citharistes regius* (scale = 10 μm) redrawn from Kofoid and Skogsberg (1928); schematic Dinophysoid (after Balech (1980). (A) Lateral view; (B) dissected ventral area; (C) apical view; (D) singular plates; (E) sulcal plates. (A–E, see Dinophysiales, pg. 426).



***Amphisolenia globifera*** Stein 1883 (not illustrated)

Less than 250  $\mu\text{m}$  long with a globular posterior end and up to two antapical spines.

**Distribution:** Eupelagic; cosmopolitan in warm temperate to tropical waters.

**Genus *Triposolenia*** Kofoid 1906 (<10 spp.)

**Type:** *T. truncata* Kofoid 1906.

**References:** Balech, 1980, 1988a; Kofoid, 1906b; Kofoid & Skogsberg, 1928; Schiller, 1933; Sournia, 1986; F. J. R. Taylor, 1976.

Armored. Large cells up to 300  $\mu\text{m}$  and similar to *Amphisolenia* in form but with two "legs." Cells with head of epitheca and cingulum; neck and shoulder with the sulcal plates and lists, the central body, and two posteriorly curved extensions, resembling legs. Triangular body with three extensions. Chloroplasts probably present. Plate formula of order.

***Triposolenia truncata*** Kofoid 1906 (Plate 10)

**Description:** Same as that for genus.

**Family Dinophysiaceae** Stein 1883**Genus *Citharistes*** Stein 1883 (<5 spp.)

**Type:** *C. regius* Stein 1883.

**References:** Kofoid & Skogsberg, 1928; F. J. R. Taylor, 1976; Sournia, 1986; Balech, 1988a.

Small to medium-sized cell body, C-shaped in right lateral view with the hypotheca dorsally excavated and forming a symbiont chamber (not formed by cingular lists). Hypotheca has two additional plates in the curvature. Left sulcal list extends with ribs from the posterior cingular area to near the posterior part of the cell body. Surface areolate with pores. Chloroplasts absent.

***Citharistes regius*** Stein 1883 (Plate 10)

**Description:** Same as that for genus.

**Distribution:** Oceanic, subtropical and warm temperate seas.

**Genus *Dinophysis*** Ehrenberg 1839 (<100 spp.)

**Synonyms:** *Phalacroma* Jørgensen 1923 in part; *Prodinophysis* Balech 1944.

**Type:** *D. acuta* Ehrenberg 1839.

**References:** Kofoid & Skogsberg, 1928; Tai & Skogsberg, 1934; Abé, 1967; Steidinger & Williams, 1970; Norris & Berner, 1970; Balech, 1976b,c, 1980, 1988a; F. J. R. Taylor, 1976; Rampi & Bernhard, 1980; Dodge, 1982.

*Dinophysis* and *Phalacroma* species reportedly overlap morphologically, but they can be separated by the development and direction of the

cingular lists in combination with the height and shape of the epitheca. *Dinophysis* species have a distinctive funnel-shaped anterior cingular list. Many of the species can also be separated by the presence or absence of chloroplasts and relative distribution (Hallegraeff & Lucas, 1988), but there are several exceptions. Species in this genus have an apical pore formed by two apical plates. No doubt genetic and immunoassay studies will identify the level of relatedness among these two genera.

**Remarks:** To differentiate species use the following suite of conservative characters: dorsal and ventral (lateral) cell curvature, relative length of cell, length and shape of left and right sulcal lists, positioning of the three ribs that support the left sulcal list, ventral view, and dorsal–ventral depth of epitheca. Use the same characters for *Phalacroma* after differentiating the two genera.

***Dinophysis acuminata*** Claparède & Lachmann 1859 (Plate 11)

Small to medium species, almost oval or elliptical in shape. Posterior profile is rounded. Left sulcal list well developed, extends beyond the midpoint of the cell, and is of equal depth. Surface with areolae, each with a pore. Type E of Hallegraeff & Lucas (1988). Toxic.

**Remarks:** This species can be confused with *D. sacculus*, *D. norvegica*, *D. ovum*, and *D. punctata*. Also, *D. skagii* and *D. lachmannii* are probably variants of *D. acuminata*. Cell shape, sulcal list development, and possibly surface markings may help to differentiate species, but there still can be confusion. Within this group or complex, surface markings can range from pores to depressions with scattered pores to depressions each with a pore to areolae each with a pore and appearance may depend on age of the cell as in *Prorocentrum*.

**Distribution:** Neritic; typically cold and warm temperate waters, worldwide.

***Dinophysis acuta*** Ehrenberg 1839 (Plate 11)

Large, robust cell with a rounded dorsal curvature and a posterior broad V-shaped lateral profile. The left sulcal list extends about two-thirds of the body length and ends at or above the deepest portion of the cell below the midpoint. The R3 is at or above this point. Surface with areolations; type E of Hallegraeff & Lucas (1988). Toxic.

**Remarks:** This species can be easily confused with *D. norvegica*. The distinction between the two species can be made by determining whether the deepest portion of the cell is two-thirds the cell length or one-half and determining the length of the left sulcal list in relation to the cell length.

**Distribution:** Oceanic and neritic; cold temperate, worldwide.

Dinophysis

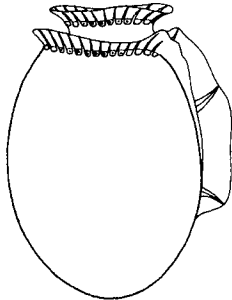

*D. acuminata*

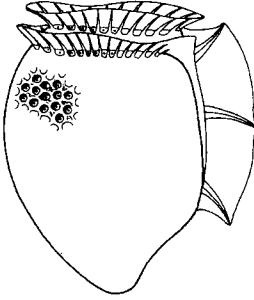

*D. norvegica*

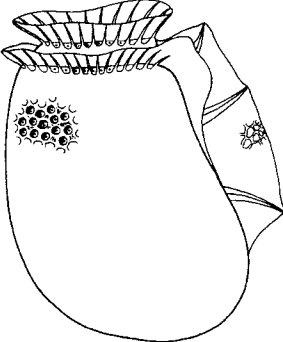

*D. fortii*

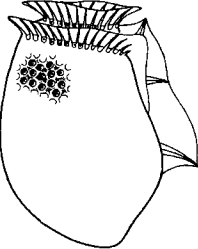

*D. acuta*

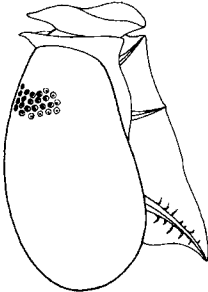

*D. dens*

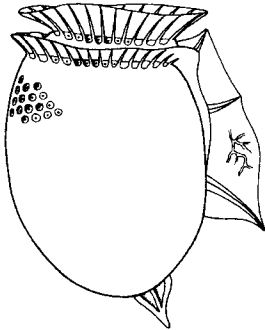

*D. odiosa*

PLATE 11 *Dinophysis acuminata*, *D. norvegica*, *D. fortii*, *D. acuta*, *D. dens*, and *D. odiosa*. Scale = 10 μm.

***Dinophysis caudata*** Saville-Kent 1881 (Plate 12)

Medium-sized species that has a characteristic posterior finger-like process; cells often occur in pairs, dorsally attached. Dorsal contour is gradually curved, whereas the ventral margin in lateral profile is generally straight along the main body. The posterior process varies in length and shape and the left sulcal list extends the length of the main body. Surface with areolations; type E of Hallegraeff & Lucas (1988). Toxic.

**Remarks:** This species superficially resembles *D. tripos* and *D. diegensis*. *D. diegensis* has been called a variety of *D. caudata*.

**Distribution:** Neritic and estuarine in warm temperate to tropical waters, worldwide; rarely found in cold water, possibly an intruder in warm water masses.

***Dinophysis dens*** Pavillard 1915 (Plate 11)

Small to medium-sized species with curved dorsal margin and angled posterior ventral margin below the R3. Cell can look like a small *D. acuta*, but it does not have the prominent postmedian depth that characterizes *D. acuta*. The left sulcal list typically has surface markings like reticulations or vermiculae, particularly between R1 and R2; depth of list is unequal and the distal margin is partially curved.

**Remarks:** This species is thought to be a variant or a gamete of *D. acuta* (Bardouil et al., 1991; MacKenzie, 1992). *Dinophysis dens* and *D. acuta* have been observed attached together as couplets in wild samples.

**Distribution:** Warm and cold water species; worldwide distribution.

***Dinophysis diegensis*** Kofoid 1907 (not illustrated)

Medium-sized cell with a slightly curved dorsal margin and an elongated, attenuated hypotheca. Left sulcal list narrow and of equal depth which extends to the point of attenuation. Main body of equal depth. Surface markings of type E of Hallegraeff & Lucas (1988).

**Remarks:** Similar to *D. caudata* but can be distinguished from that species by the width and shape of the main body and the left sulcal list.

**Distribution:** Estuarine sometimes neritic; warm temperate waters.

***Dinophysis fortii*** Pavillard 1923 (Plate 11)

Medium-sized cell, broadly subovoid, widest posteriorly. Dorsal margin curved and ventral margin almost straight. Left sulcal list long and can be up to four-fifths of the cell length. Right sulcal list also well developed and can extend beyond the R2. Surface with deep poroids, each with a pore. Surface markings of type E of Hallegraeff & Lucas (1988). Toxic.

**Distribution:** Oceanic and neritic; cold temperate to tropical waters, worldwide distribution.

Dinophysis

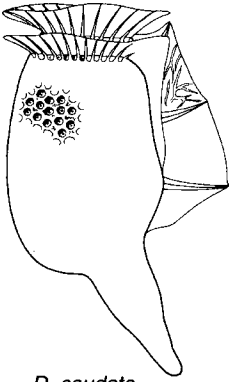

*D. caudata*

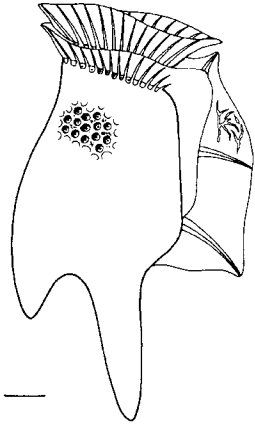

*D. tripos*

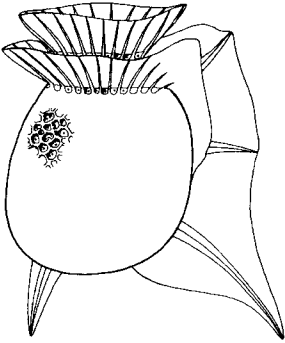

*D. uracantha*

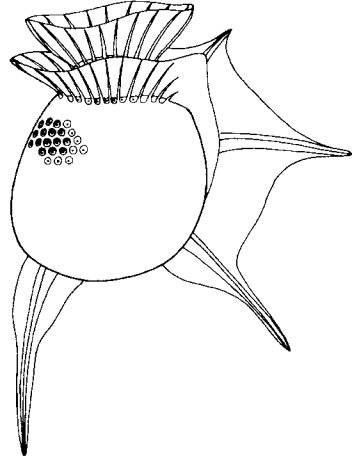

*D. schuettii*

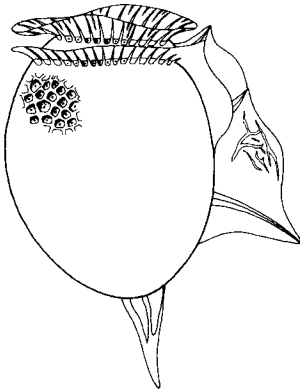

*D. hastata*

***Dinophysis hastata* Stein 1883 (Plate 12)**

Medium-sized cell with characteristic left sulcal list and R3 and curved posterior spine, with list, directed ventrally. The posterior spine is composed of fused ribs and its development may depend on the age of the cell. The R3 is typically curved distally. The shape of the main body is ovoid. Surface markings of depressions with scattered pores, type B of Hallegraeff & Lucas (1988).

**Remarks:** There are several species that can be confused with *D. hastata*. This is a nonphotosynthetic *Dinophysis*, but it may be phagotrophic and contain pigment.

**Distribution:** Neritic; warm temperate to tropical waters and rarely found in cold water; worldwide distribution.

***Dinophysis norvegica* Claparède & Lachmann 1859 (Plate 11)**

Large, robust cell with fully rounded dorsal curvature and a straight-angled lateral profile to the lower half of the ventral margin. The deepest part of the cell is about midway between the lower cingular list and the antapex, and the R3 of the left sulcal list occurs at this point or just above it. Plate surfaces with large areolae with pores, type E of Hallegraeff & Lucas (1988). Posterior and dorsal margins sometimes with protuberances or thick extensions called bosses. Toxic.

**Remarks:** See *D. acuta* for a comparison.

**Distribution:** Neritic; cold water species.

***Dinophysis odiosa* (Pavillard) Tai & Skogsberg 1934 (Plate 11)**

Medium-sized species, subovoid in shape and with a ribless posterior sail. Left sulcal list of unequal depth and reticulations and vermiculae often between R2 and R3. Posterior sail rarely double. Chloroplasts absent.

**Distribution:** Cold temperate to warm temperate waters.

***Dinophysis schuettii* Murray & Whitting 1899 (Plate 12)**

Small-sized species, round to subovate with a curved, reinforced posterior sail that has a median rib joined to the marginal ribs. Left sulcal list between R2 and R3 concave and shorter than ribs. Posterior sail dorsal and to the right. Chloroplasts absent. Surface markings of type B of Hallegraeff & Lucas (1988).

**Remarks:** Can be confused with *D. swezyii* and *D. uracantha*. This is a nonphotosynthetic *Dinophysis*, but it may be phagotrophic and contain some pigment.

**Distribution:** Oceanic; warm temperate to tropical waters; worldwide distribution. Considered a shade species.

***Dinophysis tripos*** Gourret 1883 (Plate 12)

Large cell with two posterior V-shaped processes, one extends almost the length of the main body and is midway between the ventral and dorsal margins, while the other is short and dorsal. The left sulcal list is broader posteriorly and has a straight margin. Type E surface markings of Hallegraeff & Lucas (1988). Toxic.

**Remarks:** The species can be distinguished from *D. caudata* by the shape of the left sulcal list and the presence of the two posterior processes.

**Distribution:** Neritic, estuarine, and oceanic; warm temperate to tropical species, rarely found in cold waters.

***Dinophysis uracantha*** Stein 1883 (Plate 12)

Medium-sized species similar to *D. schuetii* but without median rib in posterior sail, and left sulcal list between R2 and R3 not concave, but with a straight edge. Left sulcal list posterior margin with a proximal lobe. Chloroplasts absent.

**Distribution:** Oceanic, tropical to warm temperate waters; worldwide distribution. Considered a shade species.

**Genus *Histioneis*** Stein 1883 (<100 spp.)

**Synonym:** *Parahistioneis* Kofoid & Skogsberg 1928

**Type:** *H. remora* Stein 1883.

**References:** Kofoid & Michener, 1911; Kofoid & Skogsberg, 1928; Rampi & Bernhard, 1980; F. J. R. Taylor, 1976, 1987; Balech, 1988.

Armored, small to large subcircular, reniform or subreniform, dinophyoid cell bodies with ornate list and rib systems and large cingular chamber; poorly characterized species but readily recognizable group. Posterior cingular list often cup-shaped with largest portion of cingulum being posterior and with vertical support ribs. Anterior cingular area reduced, sometimes to a funnel with a small anterior cingular list. Reduced membraneous right sulcal list but extensive left sulcal list. Chloroplasts absent. Surface markings of pores to areolae.

***Histioneis depressa*** Schiller 1933 (Plate 13)

Cell small and reniform in lateral view with anterior cingular funnel; circular cingular chamber appears fused to the prominent left sulcal list. Left sulcal list sac like and directed dorsally; subovoid U-shaped space midpoint to ventral on posterior margin of cell body without surface reticulations and rib spurs.

**Remarks:** F. J. R. Taylor (1976) suggested that this species may be a variant of *H. mitchellana*.

**Distribution:** Oceanic; tropical and warm temperate waters; cosmopolitan.

Ornithocercus

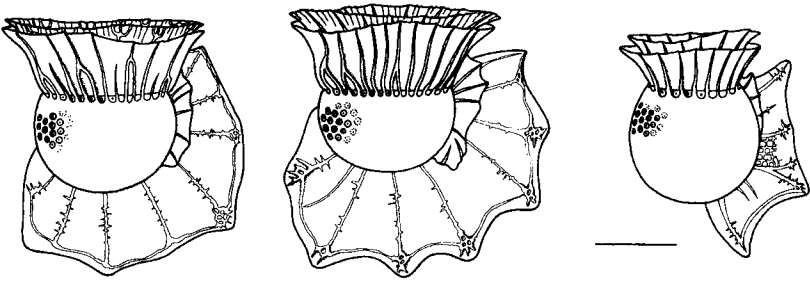

*O. thumii*

*O. steinii*

*O. heteroporus*

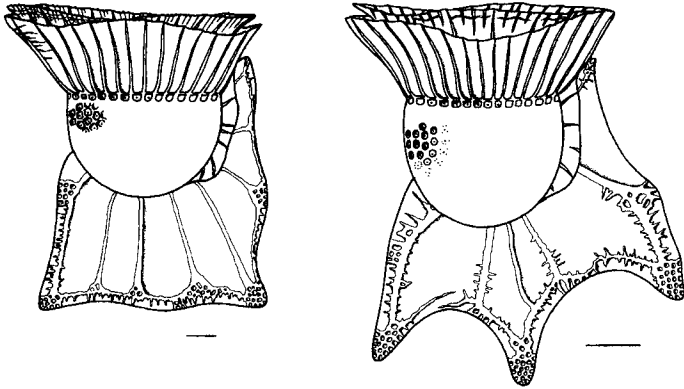

*O. quadratus*

*O. magnificus*

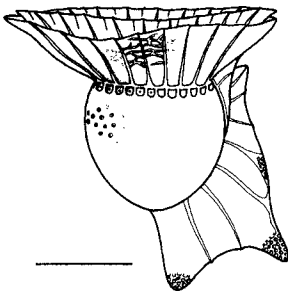

*O. splendidus*

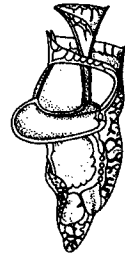

*Histioneis depressa*

PLATE 13 *Ornithocercus thumii*, *O. steinii*, *O. heteroporus*, *O. quadratus*, *O. magnificus*, *O. splendidus*. *Histioneis depressa* (redrawn from Taylor, 1976). Scale = 10  $\mu$ m.



Genus *Metaphalacroma* Tai & Skogsberg 1934 (1 sp.)

Type: *M. skogsbergii* Tai 1934.

References: Sournia, 1986; Balech, 1988.

Status of genus uncertain; compare to *Phalacroma* and *Sinophysis*.

Genus *Ornithocercus* Stein 1883 (<25 spp.)

Type: *O. magnificus* Stein 1883.

References: Norris, 1969; Steidinger & Williams, 1970; F. J. R. Taylor, 1971, 1973, 1976, 1987; Sournia, 1986; Balech, 1988a.

Small to medium-sized circular full body in lateral view with extensive sulcal and cingular list and rib systems that characterize the species. Ribs and lists are formed at the extremities of plates, near sutures. Body surface markings of pores, poroids, or areolae. Lacks chloroplasts, but can have photosynthetic symbionts in cingular chamber.

Remarks: Species of this genus can be differentiated by size and shape.

*Ornithocercus heteroporus* Kofoid 1907 (Plate 13)

A small *Ornithocercus* with a bilobed posterior left sulcal list moiety extending to the midpoint of the posterior cell body. Two strong peripheral ribs interconnected with horizontal rib; several less-developed ribs in between. R1 bent posteriorly, sometimes with spur. Surface depressions with scattered pores.

Distribution: Oceanic, warm temperate to tropical waters; worldwide distribution.

*Ornithocercus magnificus* Stein 1883 (Plate 13)

Small cell body with well developed left sulcal list, the posterior moiety of which is trilobed with deeply arched interstitial areas. The median lobe typically has an accessory rib on either side of the V-shaped lobe, occasionally two to a side. R1 bent posteriorly, sometimes with spur. Surface areolate with scattered pores.

Distribution: Oceanic; cosmopolitan in warm temperate to tropical waters.

*Ornithocercus quadratus* Schütt 1900 (Plate 13)

Medium-sized cell body with large list extensions. Margin of left sulcal list characteristically subquadrate without posterior lobes but with a straight posterior margin. Left sulcal list extends beyond midpoint of cell in lateral view. Peripheral areas of both sulcal and cingular lists can be reticulate.

Remarks: Various forms of this species occur and are probably phenotypic variants.

Distribution: Oceanic; warm temperate to tropical waters; worldwide distribution.

***Ornithocercus splendidus* Schütt 1893 (Plate 13)**

The most ornate *Ornithocercus* described with very extensive, posterior reticulate cingular list and a posteriorly bilobed left sulcal list that reaches midpoint of the posterior cell margin in lateral view and is directed ventrally. Each prominent lobe with mass of sculptured thecal material and a well-developed rib. Other less-developed ribs present. Surface with pores.

**Remarks:** Very distinctive species.

**Distribution:** Oceanic; warm temperate to tropical waters; worldwide distribution.

***Ornithocercus steinii* Schütt 1900 (Plate 13)**

Medium-sized body with four weakly developed posterior lobes to the left sulcal list; ribs not interconnected. Right sulcal list does not extend beyond cell body posterior. Surface areolate.

**Remarks:** Often confused with *O. thumii* which has three posterior lobes and a rib to the median lobe.

**Distribution:** Oceanic; cosmopolitan in warm temperate to tropical waters.

***Ornithocercus thumii* (Schmidt) Kofoid & Skogsberg 1928 (Plate 13)**

Small cell body. Right sulcal list extends beyond posterior cell margin. Left sulcal list with three lobes to posterior moiety and a rib to the median lobe. Other ribs present and ribs interconnected. Cell surface areolate with pores.

**Remarks:** See *O. steinii*.

**Distribution:** Neritic, oceanic; warm temperate to tropical waters; worldwide distribution.

**Genus *Phalacroma* Stein 1883 (<100 spp.)**

**Type:** *P. prodictyum* Stein 1883

**References:** Kofoid & Skogsberg, 1928; Tai & Skogsberg, 1934; Abé, 1967b; Balech, 1976b; Steidinger & Williams, 1970; Rampi & Bernhard, 1980; Hallegraeff & Lucas, 1988.

Medium to large cells. Epitheca detectable above the anterior cingular list in lateral view. Cingular lists typically narrow and directed horizontally rather than the anterior cingular list forming a funnel-shaped fan. Most species nonphotosynthetic and of oceanic distribution.

**Remarks:** See *Dinophysis*. Many authors consider *Phalacroma* to be synonymous with *Dinophysis*.

***Phalacroma argus* Stein 1883 (Plate 14)**

Medium-sized, egg-shaped cell with the widest part at the cingulum. R3 not well developed or may be absent.

Phalacroma

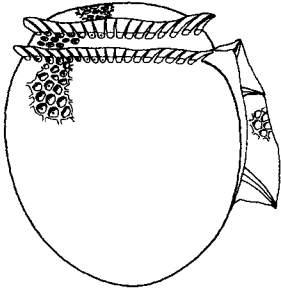

*P. rotundatum*

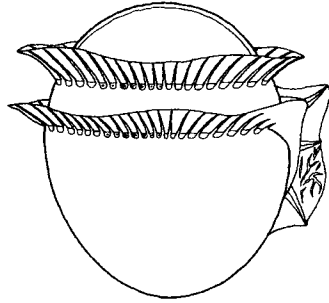

*P. argus*

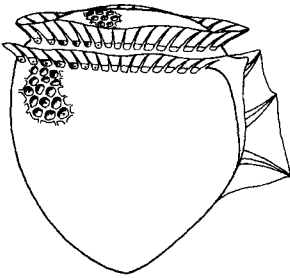

*P. mitra*

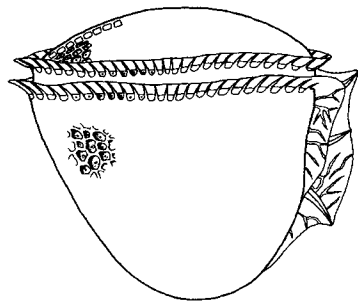

*P. cuneus*

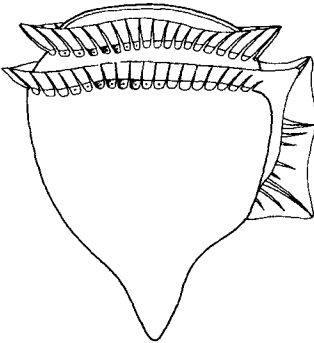

*P. fавus*

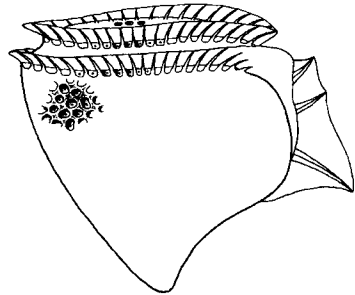

*P. rapa*

**Distribution:** Oceanic; warm temperate to tropical waters; worldwide distribution.

***Phalacroma cuneus*** Schütt 1895 (Plate 14)

Medium-sized cell that is broadest anteriorly and is narrowest posteriorly. Left sulcal list is curved distally. Surface reticulate with a pore in almost every depression.

**Distribution:** Oceanic; warm temperate to tropical waters; worldwide distribution.

***Phalacroma doryphorum*** Stein 1883 (Plate 17)

Characteristic triangular ribless posterior sail not connected to the left sulcal list. Ventral edge of left sulcal list almost straight. Surface markings of shallow depressions with scattered pores.

**Distribution:** Neritic and pelagic; warm temperate to tropical waters; worldwide distribution.

***Phalacroma favus*** Kofoid & Michener 1911 (Plate 14)

Distinctive medium-sized cell with posterior finger-like projection.

**Distribution:** Warm water species; subtropical, tropical, and occasionally warm temperate waters; worldwide distribution.

***Phalacroma mitra*** Schütt 1895 (Plate 14)

Posterior portion of hypothecal plates concave from R3 to anapex. Produces okadaic acid. Toxic.

**Remarks:** Similar to *P. rapa*.

**Distribution:** Warm temperate to tropical oceanic and neritic waters; worldwide distribution.

***Phalacroma rapa*** Jorgensen 1923 (Plate 14)

In lateral view, the left ventral margin from R1 to R3 is angled making the left sulcal list extend out at about a 45–60° angle perpendicular to the depth axis.

**Remarks:** Similar to *P. mitra*.

**Distribution:** Oceanic and neritic; temperate to tropical waters; worldwide distribution.

***Phalacroma rotundatum*** (Claparède & Lachmann) Kofoid & Michener 1911 (Plate 14)

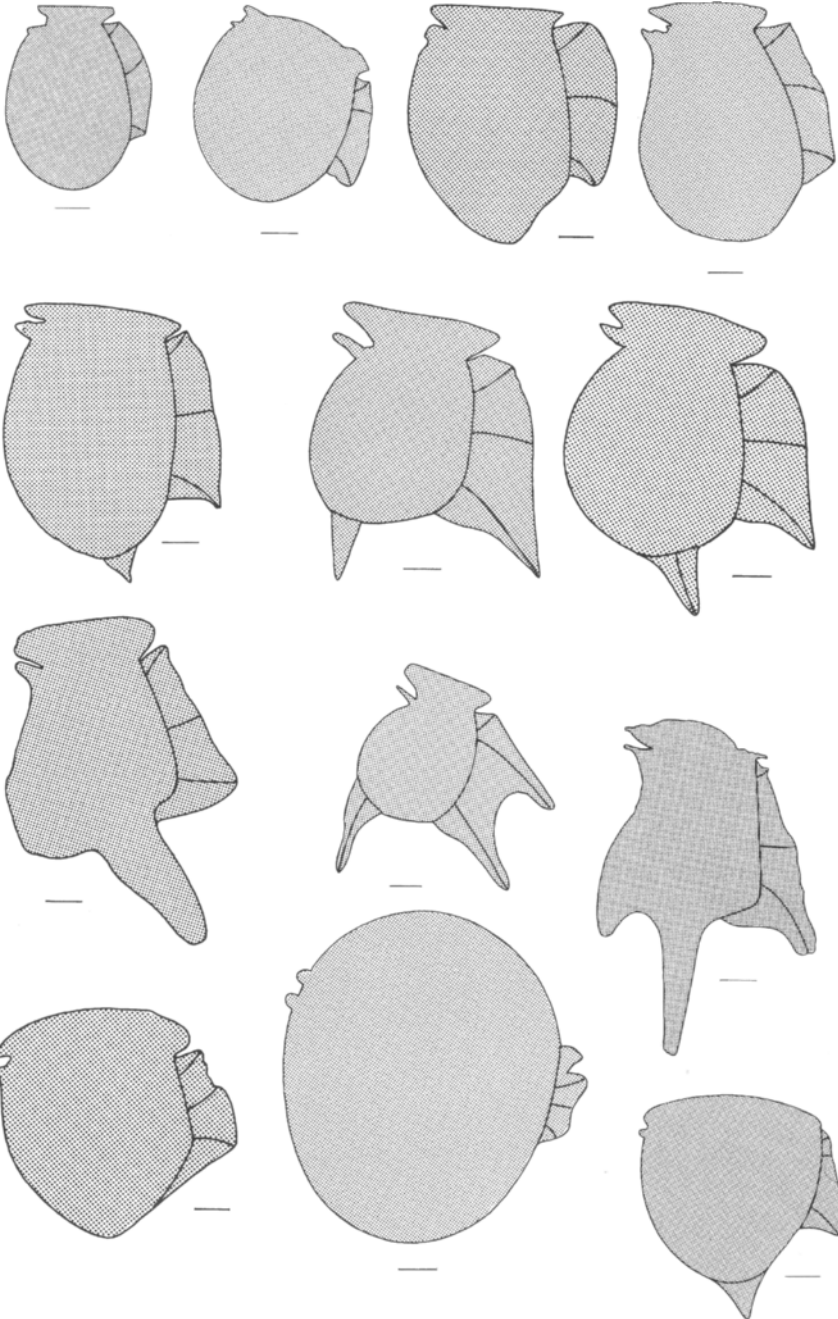

PLATE 15 Silhouettes of *Dinophysis* and *Phalacroma* species for comparison of size and shape. The scale = 10  $\mu$ .

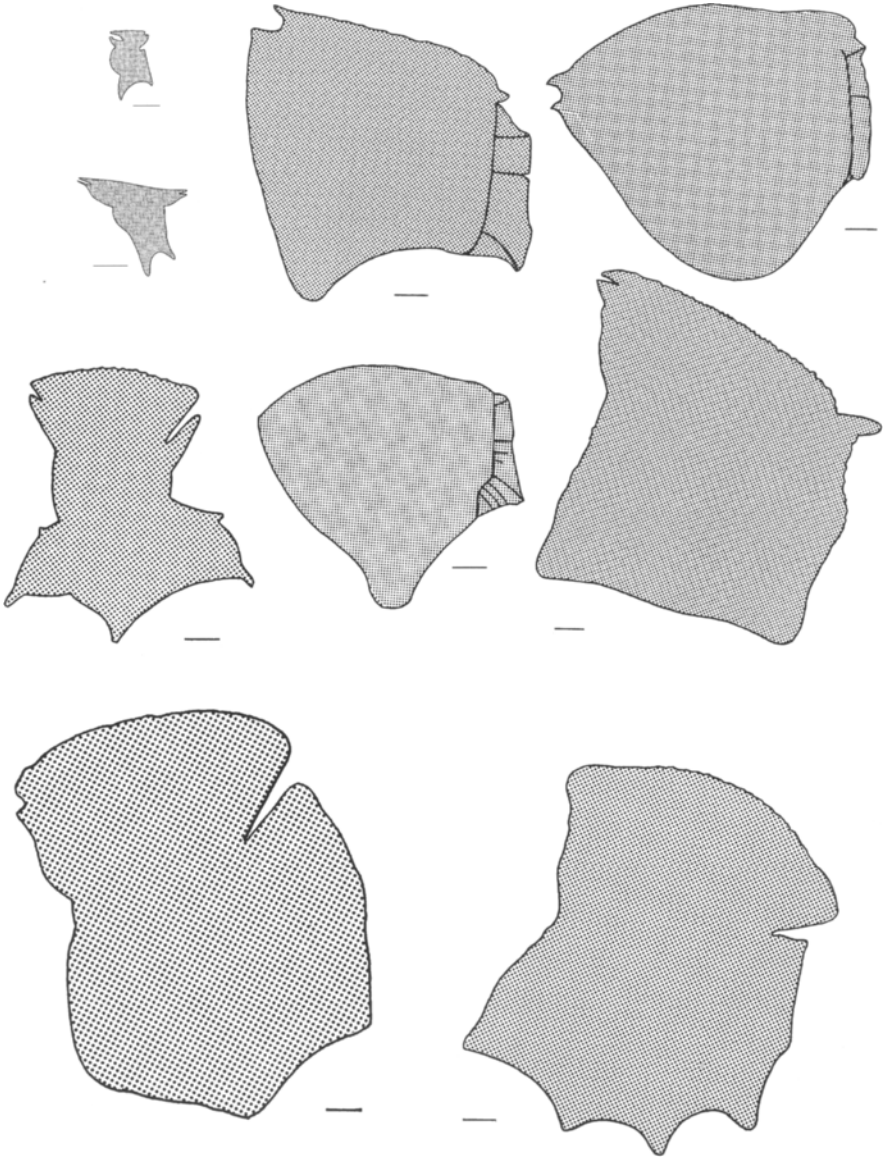

PLATE 16 Silhouettes of *Phalacroma* and *Ornithocercus* species for comparison of size and shape. The scale = 10  $\mu$ .

Small to medium-sized cell. In lateral view, body almost round with concave ventral and dorsal edges. The left sulcal list extends from greater than one-half to almost three-fourths the length of the hypotheca. Produces okadaic acid. Toxic.

**Remarks:** This species can be confused with *P. rudgei* which has a more prominent epitheca and a larger body size.

**Distribution:** Cold and warm waters; cosmopolitan.

**Genus *Sinophysis*** Nie & Wang 1944 (<5 spp.)

**Type:** *S. microcephala* Nie & Wang 1944.

**References:** Nie & Wang, 1944; Balech, 1967a, 1980, 1988a; Saunders & Dodge, 1984; Faust, 1993b.

Small dinophysoid with a subcircular shape in lateral view. Theca areolate or smooth. Epitheca small and less wide than hypotheca. Large apical pore in right epithecal plate; epithecal plates asymmetric. Sulcus with narrow left and right lists, but lists not well developed; sigmoid left list more prominent. Posterior cingular list vertical resembling a collar; anterior list thinner and slightly upturned. Chloroplasts absent, but feeds phagotrophically. Nucleus located posteriorly.

***Sinophysis microcephala*** Nie & Wang 1944 (Plate 17)

Theca areolate (mean of ca. 460) with scattered pores in areolae. Several larger pores between areolae. Left epitheca plate with different surface ornamentation and large openings resembling pores.

**Distribution:** Benthic; warm temperate and tropical waters. Cosmopolitan.

**Family Oxyphysaceae** Sournia 1984

**Genus *Oxyphysis*** Kofoid 1926 (1 spp.)

**Type:** *O. oxytoxoides* Kofoid 1926.

**References:** Kofoid, 1926; Sournia, 1986; Balech, 1988a; Fensome et al., 1993.

Armored, medium-sized, laterally compressed, subfusiform cell. Length <4× width. Most of cell areolate with scattered pores. Epitheca well developed and asymmetrical with anterior spine on right; not as wide as hypotheca. Ventral pore near apex. Cingulum barely displaced and slightly premedian. Hypotheca with laterally convex sides; attenuated with antapex directed ventrally. Sulcal lists short and not well developed. Chloroplasts absent; heterotrophic.

**Remarks:** Kofoid (1926) considered this monospecific genus a link between the Dinophysiales and the Peridinales because of its similarities with *Oxytoxum*.

***Oxyphysis oxytoxoides*** Kofoid 1926 (Plate 17)

**Description:** Same as that for genus.

**Remarks:** This species is common in many waters but often overlooked; probably misidentified as a *Oxytoxum*. It may be that the coastal cold water form and the warm temperate estuarine/coastal form are two different species.

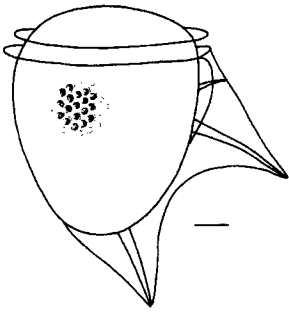

*Phalacroma doryphorum*



*Oxyphysis oxytoxoides*

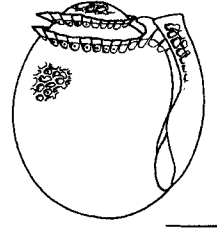

*Sinophysis microcephala*

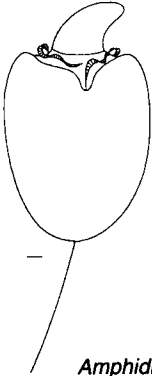

*Amphidinium carterae*

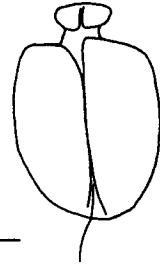

*Amphidinium poecilochroum*

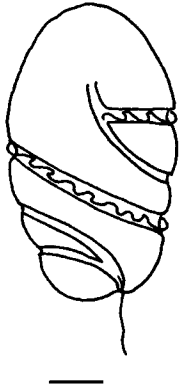

*Cochlodinium citron*

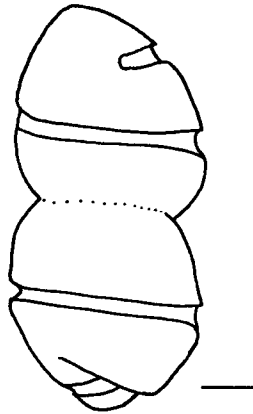

*Cochlodinium polykrikoides*

PLATE 17 Scale = 10  $\mu$ m unless otherwise indicated. *Phalacroma doryphorum*, *Oxyphysis oxytoxoides*, *Sinophysis microcephala*. *Amphidinium carterae* redrawn from Dodge & Crawford (1968) (scale = 1  $\mu$ m); *Amphidinium poecilochroum* (scale = 2  $\mu$ m); *Cochlodinium citron* redrawn from Kofoid & Swezy (1921); *C. polykrikoides*.



**Distribution:** Estuarine to open water. Cold and warm temperate waters, worldwide distribution.

**Order Gymnodiniales** Lemmermann 1910

**References:** Schiller, 1933; Loeblich III, 1982; Sournia, 1986; Fensome et al., 1993.

Order consists of three families: Gymnodiniaceae Lankester, Polykrikaceae Kofoid & Swezy, and Warnowiaceae Lindemann.

Unarmored dinokont type cells with distinct cingulum and sulcus. Thecal vesicles without thecal plates although there may be osmophilic material. With or without chloroplasts, nematocysts, ocelli, or siliceous internal structures.

**Family Gymnodiniaceae** Lankester 1885

**Genus *Amphidinium*** Claparède & Lachmann 1859 (<100 spp.)

**Synonym:** *Trochodinium* Conrad 1926.

**Type:** *A. operculatum* Claparède & Lachmann 1859.

**References:** Kofoid & Swezy, 1921; Schiller, 1933; Dodge & Crawford, 1968; Campbell, 1973; Dodge, 1982; Klut et al., 1985, 1988; Roberts et al., 1988; Taylor, 1971a; Larsen, 1985, 1988.

Unarmored. Small to large cells that can be round, top-shaped, biconical, to strongly laterally or dorsoventrally compressed. Cell with or without thick theca and with or without longitudinal ridges or ribs.

Epitheca short, less than or equal to one-third of the body length.

Cingulum distinctly premedian, with or without descending displacement. A fibrous ventral ridge has been described for some *Amphidinium* as has a peduncle for the activity of phagocytosis. Chloroplasts or cleptochloroplasts present.

**Remarks:** Species in this genus are differentiated on the following characters: shape and contours, size, lateral or dorsoventral compression; the presence of striae, ribs, or furrows, sulcus extending onto epitheca; and color. Laterally flattened species are principally interstitial and adapted to a benthic habitat; they can exhibit diurnal and lunar periodicity in vertical movement through sediments. Other species that are benthic and not laterally compressed can also migrate up into the water column when entrained by some cue, e.g., photoperiod. An example of the latter is *A. carterae* which is a bloom organism.

***Amphidinium carterae*** Hulburt 1957 (Plate 17)

Smaller version of *A. operculatum* but with the chloroplast being mostly parietal, supporting a central pyrenoid, and appearing to have less pigment. Cell surface with glycocalyx. Toxic.

**Remarks:** One of the most common *Amphidinium* that undergoes daily vertical migrations into the water column from the benthos.

**Distribution:** Cosmopolitan in temperate and tropical waters.

***Amphidinium operculatum*** Claparede & Lachmann 1859 (not illustrated)

**Synonym:** *A. klebsii* Kofoid & Swezy 1921

Small, elliptical to round cell with premedian cingulum in a Y configuration with sulcus, not a T configuration. Cingulum not complete. Epitheca asymmetric and directed to the left, tongue or beak shaped in dorsal view. Cell dorsoventrally compressed. Chloroplast(s) multilobed with lamellae running through a central pyrenoid; chloroplast pigment often obscures other cell organelles. Nucleus posterior in hypotheca.

Toxic.

**Remarks:** Schiller (1933) and Campbell (1973) among others, consider *A. klebsii* a separate species based on shape of the epitheca. Dodge (1982) and Larsen (1985) consider the two species to be synonymous.

**Distribution:** Cosmopolitan in temperate to tropical estuarine and coastal waters.

***Amphidinium poecilochroum*** Larsen 1985 (Plate 17)

Small, oblong to round cell with premedian cingulum in a T configuration with sulcus. Cingulum slightly displaced and descending. Epitheca small and not as wide as hypotheca. Sulcus reaches the rounded antapex.

Heterotrophic/mixotrophic nutrition; cleptochloroplasts present.

**Distribution:** Recently described benthic species from the Danish Wadden Sea.

**Genus *Cochlodinium*** Schütt 1896 (<50 spp.)

**Type:** *C. strangulatum* (Schütt) Schütt 1896.

**References:** Kofoid & Swezy, 1921; Schiller, 1933; Steidinger & Williams, 1970; Campbell, 1973; Takayama, 1985; Sournia, 1986.

Unarmored. Gyrodinioid cells, small to medium sized, with greater than 1.5× cingular rotation. Usually with apical groove. Single cell or chain-forming species. Body sometimes appears twisted due to cingular torsion.

Nematocysts and ocelli absent. Chloroplasts present or absent.

Encystment common.

**Remarks:** Species in this genus are differentiated based on the following characters: shape and contours, size, amount of cingular rotation or number of turns, the presence of striae or ribs, and color.

***Cochlodinium citron*** Kofoid & Swezy 1921 (Plate 17)

Small to medium-sized subellipsoidal cell with broadly rounded epitheca and hypotheca. Cingulum with more than two turns or rotations. Sulcus slightly invades epitheca. Apical groove circular, not complete. Periphery of cell with blue-green rodlets. Chloroplasts absent. Nucleus spherical and in anterior half of cell.

**Distribution:** Temperate and subtropical neritic waters.

***Cochlodinium polykrikoides* Margelef 1961 (Plate 17)****Synonym:** *C. heterolobatum* Silva 1967

Chain forming gyrodinoid; in chain, cell compressed but individual small-sized free cells are ellipsoidal. Epitheca conical; hypotheca bilobed.

Cingulum excavated and displaced; 1.8–1.9 body turns. Associated with fish kills. Toxic.

**Distribution:** Warm temperate and tropical waters; cosmopolitan.**Genus *Gymnodinium* Stein 1878 (>200 spp.)****Synonyms:** *Aureodinium* Dodge 1982; *Ceratodinium* Conrad 1926;*Ptychodiscus* Stein 1883 in part.**Type:** *G. fuscum* (Ehrenberg) Stein 1878.

**References:** Kofoid & Swezy, 1921; Lackey, 1956; Kimball & Wood, 1965; Steidinger & Williams, 1970; Campbell, 1973; Dodge, 1982; Larsen, 1985, 1994; Takayama, 1985; Sournia, 1986; Steidinger et al., 1989; Steidinger, 1990, 1993.

Unarmored. Small to large cells with varied morphology from spherical to biconical and lobed to pyriform. Single cell or chain-forming species.

Theca with or without longitudinal ridges or ribs. Cingulum usually equatorial or premedian, with or without descending displacement (left handed). If displaced, less than one-fifth body length. Sulcus often invading epitheca. Apical groove present or absent. Chloroplasts present or absent. Color can be green, yellow, brown, blue, or pink.

**Remarks:** There are *Gymnodinium* that have a cingulum displacement that can be more or less than one-fifth the cingulum width in both natural and cultured specimens (see Kimball & Wood 1965; Steidinger & Williams, 1970; and Larsen, 1985 for a discussion on the separation of *Gymnodinium* and *Gyrodinium*). In addition there are small *Woloszynskia*, *Heterocapsa*, *Scrippsiella* and other estuarine and brackish water species of <15  $\mu\text{m}$  that are often mistaken as *Gymnodinium* species. The species in this genus are differentiated based on the following characters: shape and contours, size, chain formation, the presence and shape of apical groove; cingulum premedian, median, or postmedian; displacement of cingulum; sulcus extending onto epitheca; sulcal–apical groove juncture; shape of ventral ridge; the presence of striae, ribs, or furrows; the presence of chloroplasts; placement of nucleus; and color.

***Gymnodinium abbreviatum* Kofoid & Swezy 1921 (Plate 19)**

Medium to large cell, circular in cross section, half as wide as long.

Epitheca subconical, hypotheca asymmetrical and notched by sulcus at antapex. Cingulum premedian and descending 2 $\times$ . Theca thick and striated. Chloroplasts absent but with pink or blue cytoplasm.

**Distribution:** Oceanic.

***Gymnodinium breve* Davis 1948 (Plate 18)**

**Synonym:** *Ptychodiscus brevis* (Davis) Steidinger 1979.

Small dorsoventrally flattened cell with rounded epitheca and apical process or carina directed ventrally. Hypotheca notched and slightly bilobed. Cell ventrally concave, dorsally convex. Larger cells more concave but with the right side wider and flatter than the left. Left and right sides can contract ventrally, presumably from horizontally arranged microtubules. Cingulum equatorial and descending up to 2x. Cingulum with longitudinal thecal ridges. Sulcus invades epitheca about one-third the height. Apical groove starts to the right of the distal epithecal end of the sulcus and extends onto the dorsal surface; right edge of apical groove is thicker. The apical groove is not an extension of the sulcus. The ventral edge is characteristic and somewhat broadly undulating. Nucleus round and located in posterior left quadrant. Chloroplasts present and peripheral. Chain formation noted in very dense concentrations, e.g.,  $10^8$  cells liter<sup>-1</sup>. Toxic.

**Remarks:** Several species in this complex, e.g., *G. breve* and *G. mikimotoi*, have similar morphologies and photosynthetic pigments. This complex is distinct and should be separated out as a new genus based on a suite of characters, e.g., dorsoventral flattening, dorsal left pore field, dorsal cingulum pore, cingulum-sulcus juncture, cingulum displacement, apical groove, and unique pigments.

**Distribution:** Oceanic to estuarine; warm temperate to tropical. Gulf of Mexico, southeast coast of the United States entrained in the Gulf Stream. Also recorded from the West Indies. *G. breve*-like cells recorded from Japanese, European, Australian, and New Zealand waters.

***Gymnodinium catenatum* Graham 1943 (Plate 18)**

Small cell with varied morphology depending on whether seen as chain former or single cell. Chains can be made of up to 64 slightly anterioposteriorly compressed cells. Hypotheca exceeds epitheca; epitheca truncate, rounded, or abruptly conical. Apical groove runs counterclockwise around apex; proximal end starts at end of sulcal intrusion. Theca with reticulate pattern; quilted. Chloroplasts present. Nucleus large and central. Produces characteristic cyst. Toxic.

**Remarks:** There is a similar smaller species isolated from the NW rias of Spain that is being described as a new *Gyrodinium* species; it is not toxic.

**Distribution:** Temperate waters; North America, Europe, Australia, and Japan.

***Gymnodinium galatheanum* Braarud 1957 (Plate 18)**

Small oval, gyrodinioid cell (<20  $\mu\text{m}$ ) with a displaced cingulum  $3\times$  cingular width. Sulcus slightly invades epitheca. Straight apical groove

Gymnodinium

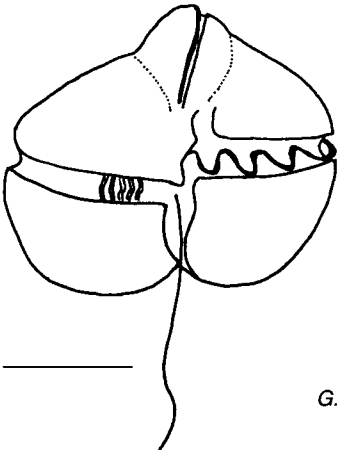

*G. breve*

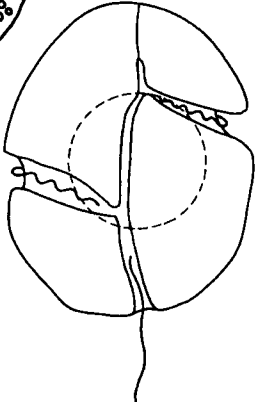
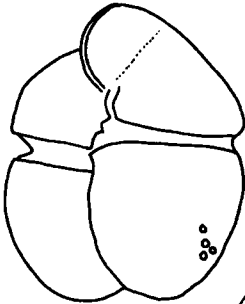

*G. galathenum*

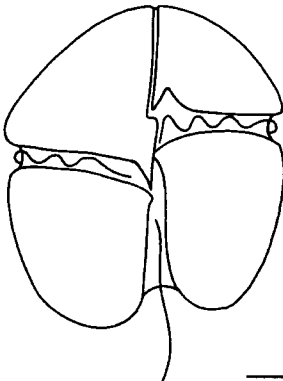

*G. mikimotoi*

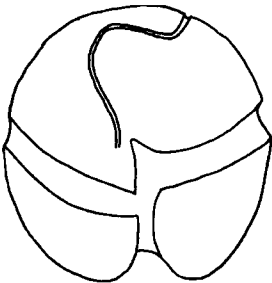
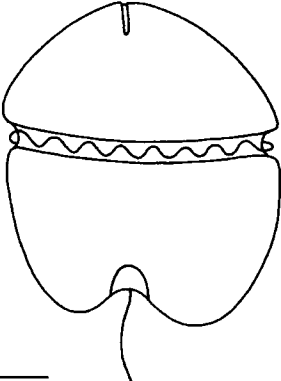

*G. pulchellum*

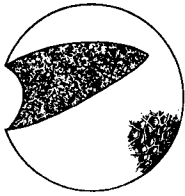

*G. catenatum*

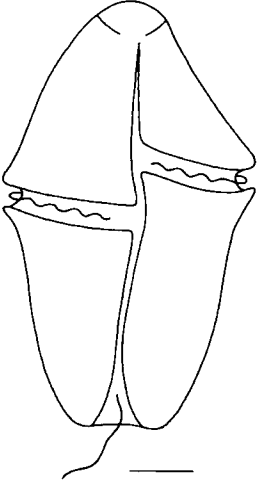

originates to the left of the sulcal intrusion. Chloroplasts present. Nucleus round and centrally located. Toxic.

**Distribution:** North Sea, British Isles.

***Gymnodinium heterostriatum*** Kofoid & Swezy 1921 (Plate 19)

Medium-sized cell with conical epitheca and rounded hypotheca, not equal. Appears circular in cross section. Cingulum circular to slightly descending. Sulcus invades epitheca to apex. Theca with longitudinal striae; hypotheca has more striae than epitheca. Chloroplasts absent; heterotrophic nutrition.

**Distribution:** Temperate; neritic waters.

***Gymnodinium mikimotoi*** Miyake & Kominami ex Oda 1935 (Plates 1 and 18)

**Synonyms:** *G. aureolum* Hulburt 1957 in part; *G. nagasakiense* Takayama & Adachi 1985.

Small, broadly oval cell that is dorsoventrally compressed. Hypotheca exceeds epitheca; epitheca is broadly rounded and hypotheca is notched and slightly bilobed. Cingulum slightly premedian and displaced  $2\times$  cingular width. Apical groove–sulcus juncture characteristic. Sulcus slightly invades epitheca; immediately to right is the proximal end of the apical groove which extends onto the dorsal epitheca and is straight. Ventral ridge inverted hook shape. Clustered pore field on left dorsal hypotheca. Chloroplasts present. Nucleus ellipsoidal and on left side near periphery. Toxic.

**Remarks:** This species is easily confused with others in this complex but can be differentiated by the apical groove–sulcus juncture and ventral ridge.

**Distribution:** Temperate to tropical neritic waters; cosmopolitan.

***Gymnodinium pulchellum*** Larsen 1994 (Plates 1 and 18)

**Synonym:** *Gymnodinium* type '84-K, Onoue et al. 1985

Small, broadly oval cell with slight dorsoventral compression. Cingulum displaced  $1\text{--}1.5\times$  cingulum widths. Apical groove characteristically reversed S shaped that terminates on the dorsal surface and originates to the right of the ventral ridge. Chloroplasts present. Nucleus ellipsoidal and on the left side. Toxic.

**Distribution:** Recorded from Japanese, Australian, Tasmanian, and Mediterranean waters.

Gymnodinium

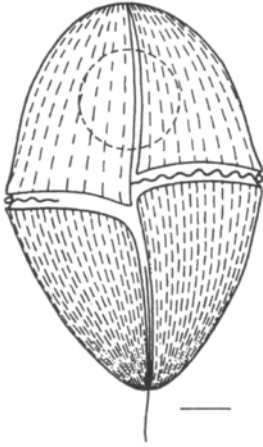

*Gymnodinium heterostriatum*

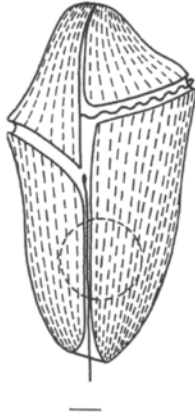

*Gymnodinium abbreviatum*



*Gyrodinium uncatenum*



*Gymnodinium sanguineum*

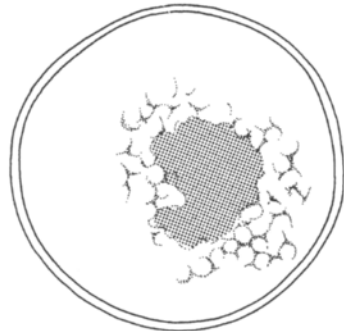

*G. uncatenum* cyst



*Gyrodinium estuariale*



*Gyrodinium instriatum*

***Gymnodinium sanguineum*** Hirasaka 1922 (Plate 19)**Synonyms:** *G. splendens* Lebour 1925; *G. nelsonii* Martin 1929

Small to medium-sized pleomorphic cell; typically pentagonal in shape with a broadly conical epitheca and a bilobed hypotheca. Epitheca and hypotheca almost equal. Cingulum displaced 1× cingulum width. Sulcus does not extend onto the epitheca but deeply notches hypotheca. Apical groove present. Chloroplasts present; radiate from center of cell. Nucleus large and central. Associated with fish kills. Toxic(?)

**Remarks:** This species can vary from about 40 to 75  $\mu\text{m}$  in length and be dorsoventrally compressed to circular in cross section, from heavily pigmented to almost colorless or pale yellow. The hypotheca can be rounded to truncate to prominently bilobed. These observations apply to natural populations as well as cultures. Often, cultures indicate the phenotypic variability that a species can express. In nature, such pleomorphism is rarely seen except in bloom conditions. This species may form resting stages surrounded by a mucoid halo.

**Distribution:** Temperate to tropical estuarine and costal waters; cosmopolitan.

**Genus *Gyrodinium*** Kofoid & Swezy 1921 (> 100 spp.)**Synonyms:** *Gymnodinium* Stein 1878 in part; *Sclerodinium* Dodge 1982; *Spirodinium* Schütt 1896.**Type:** *G. spirale* (Bergh) Kofoid & Swezy 1921.**References:** Kofoid & Swezy, 1921; Schiller, 1933; Hulburt, 1957; Campbell, 1973; Dodge, 1982; Takayama, 1985; Sournia, 1986; Gardiner et al., 1989; Larsen, 1994.

Unarmored. Small to large-sized cells. Cells fusiform, biconical, ovoid, tear shaped; sometimes compressed dorsoventrally or laterally. Cingulum displaced more than one-fifth body length in a descending left spiral, with or without overhang. Many species with cingulum displaced more than one-third body length. Sulcus often invading epitheca. Some species with apical groove. Chloroplasts present or absent. Pigmentation and nutrition vary. In phagotrophic species, food vacuoles often present.

**Remarks:** *Gyrodinium* and *Gymnodinium* are distinguished based on whether the cingulum displacement is more or less than one-fifth the body length. Steidinger & Williams (1970) and others have discussed why this is not a conservative character for generic separation. There are other characters such as fusiform, ovoid, or conical, in conjunction with more



than one-third the body length that may separate out the *Gyrodinium* based on the type species. Currently, the species in this genus are differentiated by the following characters: shape and contours; size; the presence and shape of apical groove; the presence of striae, ribs, or furrows; total displacement of cingulum; sulcus extending onto epitheca; torsion of sulcus; the presence of chloroplasts; lateral compression of body; and color.

***Gyrodinium aureolum*** Hulburt 1957 (not illustrated, see Plate 18)

**Remarks:** Same description as that for *Gymnodinium mikimotoi* in which the cingulum displacement can be less than one-fifth the body length or equal to, or exceed, one-fifth. The original species as described by Hulburt had a centrally located round nucleus, whereas *G. mikimotoi* has an ellipsoidal nucleus located on the left side of the cell at the periphery. The question remains whether or not there are two distinct species. Toxic.

**Distribution:** North Atlantic Ocean.

***Gyrodinium estuariale*** Hulburt 1957 (Plate 19)

Small (<20  $\mu\text{m}$ ) oval cell with conical epitheca and slightly lobed or subtrapezoidal hypotheca; right side of hypotheca longer than left.

Cingulum excavated and wide; displaced about  $1\times$  cingulum width and less than one-third body length.

**Remarks:** This species has an APC and probably is armored.

**Distribution:** Common species in temperate and tropical estuaries; cosmopolitan.

***Gyrodinium fissum*** (Levander) Kofoid & Swezy 1921 (not illustrated)

Similar to *G. instriatum*. Small to medium-sized ellipsoidal cell. Theca with longitudinal striations or ridges; twice as many on the hypotheca as on the epitheca. Cell circular in cross section. Kofoid & Swezy (1921) describe the cytoplasm as granular and vacuolate with radially arranged pale green rods at the cell periphery. These may or may not be chloroplasts.

**Distribution:** Neritic species in temperate waters.

***Gyrodinium instriatum*** Freudenthal & Lee 1963 (Plates 1 and 19)

Small to medium-sized, broadly oval cell; broadest at the middle. Slightly dorsoventrally compressed. Epitheca convex or slightly concave or truncate. Hypotheca bilobed with sulcus extending to antapex. Cingulum excavated but of narrow width; displaced more than one-third body length. Sulcus invades epitheca. Anterior portion of epitheca often without pigment; contains nucleus. Chloroplasts present; pigmentation yellow–brown. Forms cysts.

**Remarks:** Has been confused with *G. fissum* which has thecal ridges or striations.

**Distribution:** Common species in temperate and tropical estuarine and neritic waters; cosmopolitan.

***Gyrodinium lachryma*** (Meunier) Kofoid & Swezy 1921 (Plate 20)

Large, tear-shaped cell with attenuated, pointed epitheca directed to the right. Cingulum descending and displaced >10 cingular widths. Sulcus extends almost to antapex. Surface with light striations. Chloroplasts absent.

**Distribution:** Oceanic and coastal, boreal and cold temperate waters.

***Gyrodinium pingue*** (Schütt) Kofoid & Swezy 1921 (not illustrated)

Small to medium-sized oval-shaped species. Epitheca and hypotheca conical; hypotheca wider. Cell circular in cross section. Cingulum displaced more than one-third body length. Sulcus invades epitheca and extends to antapex. Theca with fine striations or ribs. Chloroplasts absent. Food vacuoles present. Nucleus spherical and near-median. Cytoplasm diffuse pale green; short blue-green rodlets at the cell periphery.

**Distribution:** Neritic, temperate waters of the Atlantic and Pacific Oceans.

***Gyrodinium spirale*** (Bergh) Kofoid & Swezy 1921 (Plate 20)

Medium to large-sized spindle-shaped asymmetric cell with slight longitudinal twist. Cingulum excavated and narrow; displaced more than one-third body length. Epitheca curved to right with pointed apex, antapex slightly bilobed with right side longer than left. Chloroplasts absent. Nucleus elongate and median. Food vacuoles present.

**Remarks:** This may represent a species complex with several similar species.

**Distribution:** Temperate to subtropical waters; cosmopolitan.

***Gyrodinium uncatenum*** Hulburt 1957 (Plate 19)

Medium-sized cell, slight lateral compression. Epitheca rounded, hypotheca bilobed. Cingulum displaced more than one-third body length. Sulcus sigmoid and invades epitheca, slightly curved to left. Chloroplasts present. Nucleus spherical and in epitheca. Forms cysts.

**Distribution:** Estuarine in temperate waters.

**Genus *Katodinium*** Fott 1957 (<30 spp.)

**Synonym:** *Massartia* Conrad 1926.

**Type:** *K. neuportense* (Conrad) Loeblich Jr. & Loeblich III 1966.

**References:** Kofoid & Swezy, 1921; Fott, 1957; Loeblich III, 1965; Loeblich & Loeblich, 1966; Dodge & Crawford, 1970; Campbell, 1973;

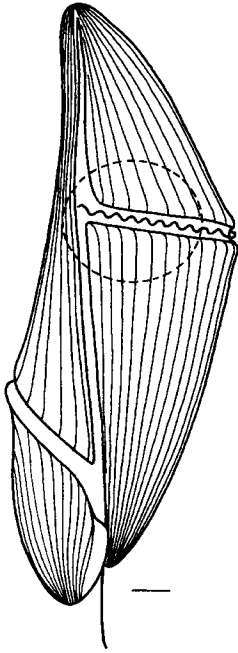

*Gyrodinium spirale*

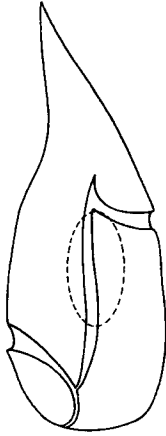

*Gyrodinium lachryma*

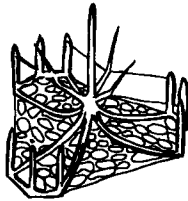

*Katodinium scale*

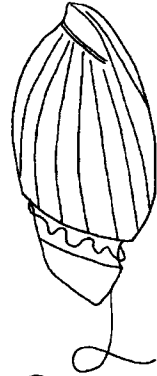

*Katodinium glaucum*

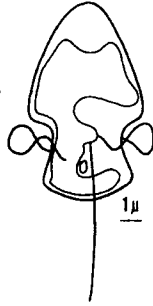

*Katodinium rotundatum*



*Torodinium teredo*

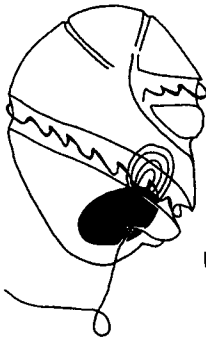

*Nematodinium armatum*

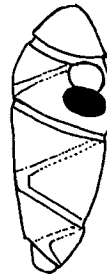

*Warnowia polyphemus*

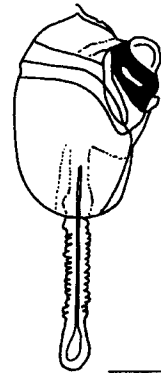

*Erythrosideinium agile*

Spero & Moree, 1981; Spero, 1982; Takayama, 1985; Sournia, 1986; Hansen, 1989; Popovsky & Pfeister, 1990.

Unarmored/armored. Small gymnodinioid cells with a postmedian cingulum which is often difficult to delineate. Cells pear shaped or inverted top shaped, pendulate, club, or “mushroom” shaped. Theca with or without ridges or ribs. Epitheca exceeds hypotheca by 2x. Thecal vesicles with thin plates. Outer membrane covered with characteristic scales similar to *Heterocapsa*. Triangular scales with six radiating ribs and nine peripheral spines. Chloroplasts present or absent.

**Remarks:** This genus contains many small freshwater and estuarine species. TEM by Dodge & Crawford (1970) and Hansen (1989) showed thin thecal plates in thecal vesicles of *K. rotundatum*. Also, recent SEM of several other estuarine dinoflagellates (5 to 15  $\mu\text{m}$ ), which would be characterized as *Gymnodinium* or *Katodinium* by light microscopy, reveals that they are armored and have plate patterns and tabulations fitting the Peridinales, but they lack scales. At least some *Katodinium* are probably armored. Until the type species is studied in more detail, the placement of *Katodinium* is in question.

***Katodinium fungiforme*** (Anissimova) Loeblich III 1965 (not illustrated)

Small cell with descending cingulum, 1–1.25 $\times$ . Epitheca rounded, hypotheca asymmetrical. Epitheca broader than hypotheca. No apparent plates in thecal vesicles, although there is osmophilic material.

**Remarks:** Common estuarine species.

**Distribution:** Benthic and planktonic. Widely distributed in estuarine waters; cosmopolitan.

***Katodinium glaucum*** (Lebour) Loeblich III 1965 (Plates 1 and 20)

**Synonym:** *Spirodinium glaucum* Lebour 1917.

Small fusiform cell theca thick, with about 20 longitudinal ribs on epitheca and 2 or 3 on hypotheca; epitheca has circular apical groove. cingulum displaced 4 or 5 $\times$  cingulum width and about one-fifth of body. Epitheca exceeds hypotheca in both length and width. Chloroplasts absent; food vacuoles present. Nucleus round and in epitheca.

**Remarks:** This is an easily recognizable species.

**Distribution:** Common estuarine species; temperate to tropical waters. Cosmopolitan.

---

PLATE 20 Scale = 10  $\mu\text{m}$  unless otherwise indicated. *Gyrodinium spirale* and *G. lachryma* redrawn from Kofoid & Swezy (1921); *Katodinium glaucum*; *K. rotundatum* (scale = 1  $\mu\text{m}$ ); and *Katodinium* scale redrawn from Hansen (1989); *Torodinium teredo*, *Nematodinium armatum*, *Warnowia polyphemus*, and *Erythrospidinium agile* (scale = 50  $\mu\text{m}$ ) redrawn from Kofoid & Swezy (1921).

***Katodinium rotundatum*** (Lohmann) Loeblich III 1965 (Plate 20)

Small “mushroom”-shaped cell in which epitheca exceeds hypotheca in both length and width. Reported to have apical pore or opening in an apical groove structure.<sup>1</sup>

**Distribution:** Common estuarine species in temperate to tropical waters; cosmopolitan.

**Genus *Torodinium*** Kofoid & Swezy 1921 (<5 spp.)

**Type:** *T. teredo* (Pouchet) Kofoid & Swezy 1921.

**References:** Kofoid & Swezy, 1921; Schiller, 1933; Steidinger & Williams, 1970; Campbell, 1973; Dodge, 1982; Sournia, 1986.

Unarmored. Distinctive small to medium-sized cell. Body cigar shaped. Epitheca exceeds hypotheca (>5×) and sulcus extends almost entire length of cell. Sulcus and cingulum join posteriorly to form antapical loop. Chloroplasts present.

***Torodinium teredo*** (Pouchet) Kofoid & Swezy 1921 (Plate 20)

Cell length >3× width. Cell with brown pigmentation. Slow swimmer.

**Remarks:** Can be distinguished from *T. robustum* by the latter’s size (<3× width), green pigmentation.

**Distribution:** Wide distribution in temperate and tropical waters.

**Genus *Lepidodinium*** Watanabe, Suda, Inouye, Sawaguchi, & Chihara 1990

**Type:** *L. viride* Watanabe et al. 1990.

**Reference:** Watanabe et al., 1990.

Unarmored. Small gymnodinoid cell with an apical groove. Surface covered with organic scales. Theca without plate material in vesicles.

Cingulum descending and displaced about 1×.

**Remarks:** The closely related genus *Gymnodinium* was not described with body scales and the type species lacks scales. The theca of the type species, *G. fuscum*, contains vesicles with a similar membrane profile just above the inner vesicle membrane as in *Lepidodinium*.

***Lepidodinium viride*** Watanabe et al. 1990 (not illustrated)

Small, subglobular cell which is compressed dorsoventrally. Apical groove extends from the sulcus to the apex and curves counterclockwise around the apex. Short club-shaped or finger-shaped structure in anterior sulcal region. Green color due to vestigial symbiont that has chlorophylls a and b. Cell does not have two nuclei, just one dinokaryon.

**Distribution:** Pacific Ocean; temperate and neritic.

<sup>1</sup> At the time of printing, Hansen 1995, *Phycologia* 34:166–170, demonstrated that *K. rotundatum* belongs to the genus *Heterocapsa*.

**Family Polykrikaceae** Kofoid & Swezy 1921

**Genus** *Pheopolykrikos* Chatton emend. Matsuoka & Fukuyo 1986 (<5 spp.)

**Type:** *P. beauchampii* Chatton 1933.

**References:** Chatton, 1933; Schiller, 1933; Takayama, 1985; Matsuoka & Fukuyo, 1986; Sournia, 1986.

Unarmored. Small to medium-sized two-celled pseudocolony or as single cell. Gyrodinioid cell with broadly rounded epitheca, bilobed to rounded hypotheca. Cingulum premedian and displaced, left-handed. Epitheca with apical groove. Pseudocolonial cell with one nucleus per zooid centrally located. Cell not dorsoventrally compressed and lacks nematocysts.

Chloroplasts present. Produces cysts.

**Remarks:** Cysts of this species differ from cysts of *Polykrikos* species, e.g., *P. kofoidii*.

*Pheopolykrikos hartmannii* (Zimmerman) Matsuoka & Fukuyo 1986 (Plate 21)

Cell surface without ridges. Cingulum displaced 1.5–2× width and about one-third length of body.

**Remarks:** This species may be synonymous with *Polykrikos barnegatensis* Martin 1929.

**Distribution:** Temperate and tropical waters; cosmopolitan.

**Genus** *Polykrikos* Bütschli 1873 (<5 spp.)

**Type:** *P. schwartzii* Bütschli 1873.

**References:** Kofoid & Swezy, 1921; Schiller, 1933; Steidinger & Williams, 1970; Morey-Gaines & Ruse, 1980; Harland, 1981; Dodge, 1982; Takayama, 1985; Sournia, 1986; Fensome et al., 1993.

Unarmored. Medium to large-sized pseudocolonial cell of 4 to 16 zooids or single cells. Gyrodinioid or gymnodinioid zooids closely appressed longitudinally without cellular septations, each component with its own cingulum but all sharing a common, continuous sulcus. Cingulum equatorial or slightly displaced. Apex with apical groove. Species with >2 zooids usually have one nucleus per 2 zooids. Chloroplasts absent.

Nematocysts present or absent. Food vacuoles often present.

**Remarks:** Active phagocytic nutrition, feeding on other dinoflagellates such as *Ceratium*, *Protoperidinium*, *Scrippsiella*, *Gonyaulax*, and others, as well as diatoms.

*Polykrikos kofoidii* Chatton 1914 (Plate 21)

Single cells oval, longer than wide. Theca with striae or ridges. Resemble *Gyrodinium pellucidum*. Pseudocolony composed of 4, 8, or 16 zooids.

Polykrikos

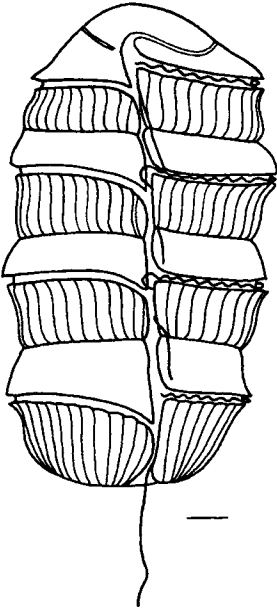

*P. kofoidii*

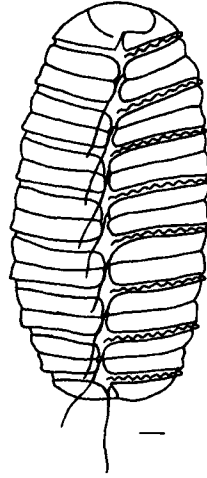

*P. schwartzii*

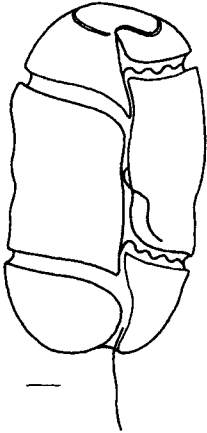

*Pheopolykrikos hartmannii*

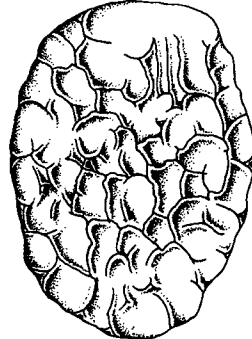

*P. schwartzii* cyst

PLATE 21 *Polykrikos kofoidii* and *P. schwartzii* redrawn from Kofoid and Swezy (1921); *Pheopolykrikos hartmannii* redrawn from Hulburt (1957); *Polykrikos* cyst. Scale = 10  $\mu$ m.

One nucleus per 2 zooids. Hypotheca of zooids with ridges or furrows. Forms characteristic cysts.

**Remarks:** Easily distinguishable from *P. schwartzii* (Plate 21) which lacks ridges in the hypotheca and has an almost equatorial cingulum. In addition, the cysts of these two species differ.

**Distribution:** Temperate to tropical waters; cosmopolitan.

#### Family Warnowiaceae Lindemann 1928

**Genus** *Erythrospidinium* Silva 1960 (10 spp.)

**Synonym:** *Erythrospis* Hertwig 1884.

**Type:** *E. agile* (Hertwig) Silva 1960.

**References:** Kofoid & Swezy, 1921; Schiller, 1933; Silva, 1960; Elbrächter, 1979; Takayama, 1985; Sournia, 1986.

Unarmored. Small to large amphidinioid cells with short epitheca; with or without apical carina; may have apical groove. Cingulum can be displaced up to 20× cingular width. Sulcus invades epitheca; no torsion. Possesses contractile tentacle, simple or compound pigment masses (red, brown, black), and simple or compound lenses. Pigment mass and ocellus median or anterior. Chloroplasts absent. Tentacle with or without stylet.

**Distribution:** Warm temperate to tropical seas.

*Erythrospidinium agile* (Hertwig) Silva 1960 (Plates 2 and 20)

Large cell with long tentacle posteriorly directed. Ocellus simple and pigment mass red. Nucleus ellipsoidal and central.

**Remarks:** There are probably several different species described as *E. agile*.

**Genus** *Nematodinium* Kofoid & Swezy 1921 (<5 spp.)

**Synonyms:** *Nematopsides* Greuet 1978; *Pouchetia* Schütt 1895.

**Type:** *N. partitum* Kofoid & Swezy 1921.

**References:** Kofoid & Swezy, 1921; Lebour, 1925; Martin, 1929; Schiller, 1933; Hulburt, 1957; Francis, 1967; Mornin & Francis, 1967; Sournia, 1986.

Small to large gyrodinoid cells with 1.5 cingular rotations. Sulcus with torsion creating posterior loop, may invade epitheca. Like *Warnowia* in that cells have melanosome and ocellus. Ocellus can be dispersed in small spherical lenses or in one. Genus characterized by the presence of nematocysts. Chloroplasts absent.

*Nematodinium armatum* (Dogiel) Kofoid & Swezy 1921 (Plate 20)

Small subellipsoidal cell with cingulum displaced more than one-third body length. Sulcal torsion creates posterior loop; sulcus invades epitheca. Black pigment mass near posterior loop. Single lens near melanosome and with concentric rings. Nucleus round or oval and in anterior half of cell.



**Remarks:** This species has been described with three different size ranges for three different geographic areas and it is suspected that there is homonymy.

**Distribution:** Estuarine and coastal; temperate to warm waters.

**Genus *Warnowia*** Lindemann 1928 (25 spp.)

**Synonyms:** *Pouchetia* Schütt 1895; *Protopsis* Kofoid & Swezy 1921.

**Type:** *W. fusus* (Schütt) Lindemann 1928.

**References:** Kofoid & Swezy, 1921; Lebour, 1925; Schiller, 1933; Hulburt, 1957; Takayama, 1985; Sournia, 1986.

Unarmored. Small to large-sized gyroinioid cell. Cingulum with one or two turns; body may appear twisted. Some species with sulcal torsion creating posterior loop. Apical groove present (Plate 2). Ocellus and red or black pigment masses present, usually median or posterior.

Nematocysts and chloroplasts absent.

**Remarks:** Species of this genus are differentiated by the following characters: shape and contours, size, fragmented, simple or compound lens, scattered or concentrated pigment mass, shape of pigment mass, position of ocellus, cingular displacement, the presence of striae or ribs, and color.

***Warnowia polyphemus*** (Pouchet) Schiller 1933 (Plate 20)

Medium-sized ellipsoidal cell. Cingulum with two turns. Ocellus in anterior part of cell with laminated lens and pigment mass.

**Distribution:** Oceanic and coastal; cold and warm temperate waters.

**Order Suessiales** Fensome et al. 1993

**Reference:** Fensome et al., 1993.

One fossil and one extant family. Extant species principally coccoid cells living as symbionts in marine invertebrates. Biflagellated motile cell dinokont type and armored with thin plates in theca vesicles. Plates arranged in seven horizontal series. The cingulum consists of two series. *Symbiodinium* species appear to be transitional between unarmored and armored.

**Family Symbiodiniaceae** Fensome et al. 1993

**Genus *Symbiodinium*** Freudenthal 1962 (<25 spp.)

**Synonym:** *Zooxanthella* Brandt 1881.

**Type:** *S. microadriaticum* Freudenthal 1962.

**References:** Freudenthal, 1962; Loeblich & Sherley, 1979; Schoenberg & Trench, 1980; Blank & Trench, 1986; Trench & Blank, 1987; Palincsar et al., 1988; Rowan & Powers, 1991; Fensome et al., 1993.

Species differentiated using size and cytology of coccoid stages and size and morphometrics of the dinospores. Chloroplasts present in both coccoid and dinospore stages.

**Remarks:** This genus was originally described as unarmored or “naked”; however, with SEM resolution of the theca of small dinospores, species are actually thinly armored with >50 plates arranged in Kofoidian series. The sutures of the plates may be delimited by nodules or papillae over the sutures. As in some *Woloszynskia*, the cingulum has a tiered series of cingular plates, and the epitheca has an apical groove or acrobase, not an apical pore complex. These characters put *Symbiodinium* in between unarmored and armored genera.

***Symbiodinium microadriaticum* Freudenthal 1962 (Plate 22)**

Very small (<10  $\mu\text{m}$ ), ovoid cell with rounded apex and antapex.

Epitheca and hypotheca almost of equal length; epitheca exceeds hypotheca in width. Cingulum wide.

**Remarks:** Many species of this endosymbiotic genus appear to be host specific, although more than one dinoflagellate species can be endosymbiotic per host. Referred to as “zooxanthellae” because of their pigmentation and symbiotic nature with marine invertebrates.

**Distribution:** Coccoid cells endosymbiotic in coelenterates and flatworms; particularly in coral reef and tropical areas. Worldwide.

**Order Ptychodiscales**

**References:** Sournia, 1986; Elbrächter, 1993; Fensome et al., 1993.

Gymnodinioid cell with well-developed pellicle.

**Remarks:** Fensome et al. (1993) place the following genera and *Berghiella* Kofoid & Michener 1911 and *Sclerodinium* Dodge 1981 in the order Ptychodiscales which they characterize as having a strongly developed pellicle. Sournia (1986) considered *Sclerodinium* a synonym of *Gyrodinium* and *Balechina* a synonym of *Gymnodinium*. Unfortunately, there is confusion with the family Kolkitziellaceae which is in the Peridinales.

**Family Ptychodiscaceae**

**Genus *Balechina* Loeblich Jr. & Loeblich III 1968 (<5 spp.)**

**Type:** *B. pachydermata* (Kofoid & Swezy) Loeblich & Loeblich 1968.

**References:** Kofoid & Swezy, 1921; Steidinger & Williams, 1970; F. J. R. Taylor, 1976; Sournia, 1986; Fensome et al., 1993.

Unarmored. Large subellipsoidal cell with thick, rigid theca; linear thecal ridges and aerolations discernible. Circular in cross section. Cingulum median and descending 0.5–2 $\times$ . Sulcus invades epitheca. Apex hyaline. Chloroplasts absent.

***Balechina coerulea* (Dogiel) F. J. R. Taylor 1976 (Plate 22)**

Large gymnodinioid cell with blue, blue–green, green or pink pigmentation. More thecal ridges on hypotheca than epitheca.

*Symbiodinium microadriaticum**Balechina coerulea**Herdmania litoralis**Ptychodiscus noctiluca*

PLATE 22 Scale = 20  $\mu\text{m}$  unless otherwise indicated. *Symbiodinium microadriaticum* (scale = 2  $\mu\text{m}$ ); *Balechina coerulea* modified from Balech (1988a); *Herdmania litoralis* (scale = 10  $\mu\text{m}$ ) redrawn from Dodge (1981a); *Ptychodiscus noctiluca* redrawn from Balech (1988a).

**Remarks:** Distinctive species.

**Distribution:** Coastal and open water. Warm water species.

**Genus** *Herdmania* Dodge 1981 (1 sp.)

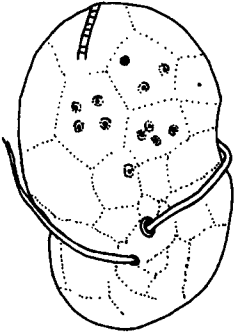
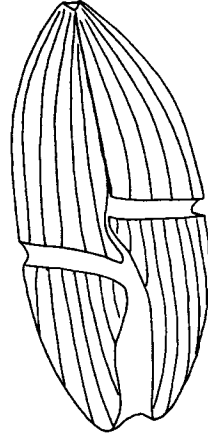
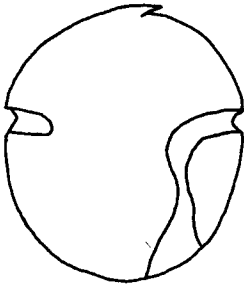
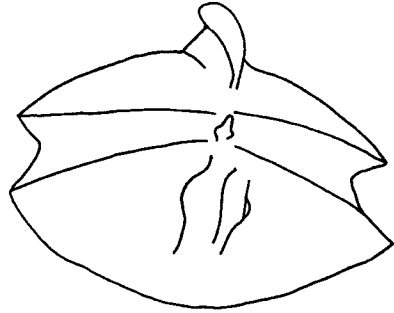
**Type:** *H. litoralis* Dodge 1981.

**References:** Herdmann, 1922; Dodge, 1981a.

Unarmored; maybe armored. Dodge characterizes the genus as having a thin theca with a few large plates. Small round cell, dorsoventrally compressed. Apex with apical notch or perhaps apical groove. Cingulum incomplete; similar to *Crypthecodinium*; ends on ventral right side.

***Herdmania litoralis*** Dodge 1981 (Plate 22)

**Description:** Same as that for genus.

**Remarks:** If this species is armored, it needs to be removed from the above family.

**Distribution:** Sand dweller; British Isles.

**Genus *Ptychodiscus*** Stein 1883 ( 1 sp.)

**Type:** *P. noctiluca* Stein 1883.

**References:** Schiller, 1933; Boalch, 1969; F. J. R. Taylor, 1976; Sournia, 1986; Steidinger, 1990; Fensome et al., 1993.

Unarmored. Medium-sized gymnodinioid cell flattened anterioposteriorly with a prominent apical carina that extends from the ventral surface onto the dorsal. Hypotheca conical; exceeds epitheca in width and length. Well-developed cingulum with ridges; slightly descending. Carina and anterior cingular edge hyaline. Theca pelliculate and resistant. Reported with and without chloroplasts and with two flagella emerging from one flagellar pore.

***Ptychodiscus noctiluca*** Stein 1883 (Plate 22)

**Description:** Same as that for genus.

**Remarks:** This species is quite variable in anterioposterior compression and form. Boalch (1969) speculated that *P. carinatus* and *P. inflatus* were synonymous with *P. noctiluca* and that confusion arose with preserved, swollen, and distorted specimens.

**Distribution:** Coastal and oceanic; cold temperate to tropical waters.

**Order Noctilucales** Haeckel 1894

**References:** Loeblich III, 1982; Sournia, 1986; Fensome et al., 1993.

Large, free-living unarmored cells that are morphologically modified for floatation and highly vacuolate. Cell with a cytosome and phagotrophic nutrition. Flagella reduced or absent.

**Remarks:** Three families: Kofoidiniaceae F. J. R. Taylor, Leptodiscaceae F. J. R. Taylor, and Noctilucaceae Kent.

**Family Kofoidiniaceae** F. J. R. Taylor 1976

**Genus *Kofoidinium*** Pavillard 1928 (<5 spp.)

**Type:** *K. velleloides* Pavillard 1928.

**References:** Cachon & Cachon, 1967a; Steidinger & Williams, 1970; F. J. R. Taylor, 1976; Sournia, 1986; Fensome et al., 1993.

Unarmored. Large inflated noctiluroid cell with epitheca, cingulum, sulcus, and two flagella. Sequential immature stages resemble *Gymnodinium* and then *Amphidinium*. There are six stages including the mature stage which is asymmetric and amphidinium-like with a laterally compressed hypotheca and an anterior, extracellular dome capable of rotation. The hypotheca with the sulcus extending along the posterior margin is sometimes referred to as a velum. The hemispherical dome is transparent. Chloroplasts absent.

***Kofoidinium velleoides*** Pavillard 1928 (Plate 23)

**Remarks:** Distinctive species.

**Distribution:** Coastal and open water; temperate to tropical. Cosmopolitan.

**Genus *Pomatodinium*** Cachon & Cachon-Enjumet 1966 (1 sp.)

**Type:** *P. impatiens* Cachon & Cachon-Enjumet 1966.

**References:** Cachon & Cachon-Enjumet, 1966; Sournia, 1986; Fensome et al., 1993.

Unarmored. Large noctiluroid cell with cingulum, sulcus, two flagella, and an extracellular anterior dome. In ventral view the cell is bilobed with the sulcus associated with the right lobe; the left lobe is J shaped extending below and under the right lobe. The hemispherical dome is transparent and rotates. The hypotheca is contractile and changes form. Chloroplasts absent.

***Pomatodinium impatiens*** J. Cachon & Cachon-Enjumet 1966 (Plate 23)

**Remarks:** Distinctive species.

**Distribution:** British Isles and Mediterranean.

**Genus *Spatulodinium*** Cachon & Cachon 1976 (1 sp.)

**Type:** *S. pseudonotiluca* (Pouchet) Cachon & Cachon ex Loeblich & Loeblich 1969

**References:** Cachon & Cachon, 1969; Loeblich & Loeblich, 1969.

Similar to *Kofoidinium* but with a ventral nonretractile tentacle. Immature stages gymnodinioid.

***Spatulodinium pseudonotiluca*** (Pouchet) Cachon & Cachon ex Loeblich & Loeblich 1969 (Plate 23)

**Remarks:** Distinctive species.

**Distribution:** Mediterranean.

**Family Leptodiscaceae** F. J. R. Taylor 1987

**Remarks:** This family contains *Leptodiscus* (type genus), *Abedinium*, *Cachoninium*, *Craspedotella*, *Cymbodinium*, *Petalodinium*, and

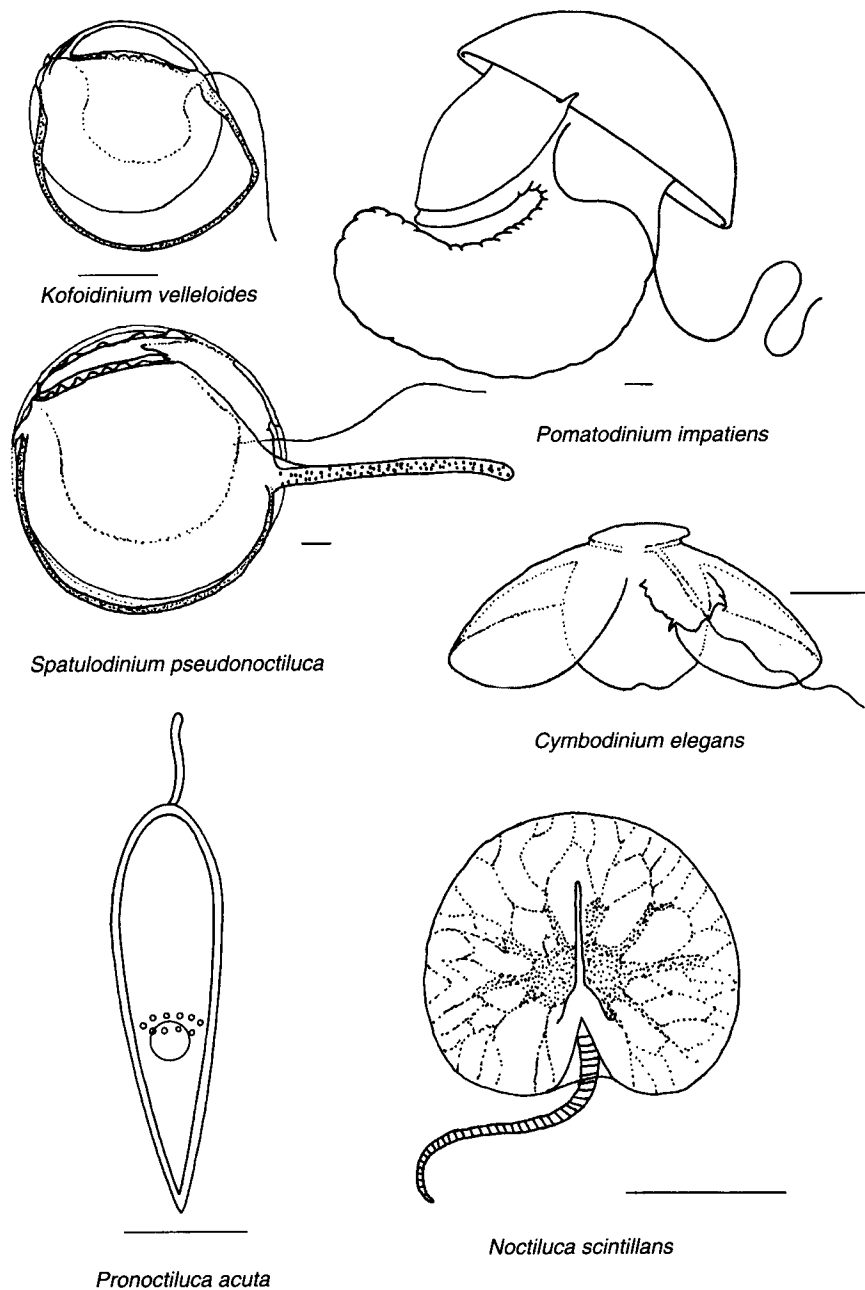

**PLATE 23** *Kofoidinium velleoides* (scale = 10  $\mu\text{m}$ ) redrawn from Cachon & Cachon (1968); *Pomatodinium impatiens* (scale = 10  $\mu\text{m}$ ) redrawn from Cachon & Cachon-Enjumet (1966); *Spatulodinium pseudonoclituca* (scale = 20  $\mu\text{m}$ ) redrawn from Cachon & Cachon (1968); *Cymbodinium elegans* (scale = 100  $\mu\text{m}$ ) redrawn from Cachon & Cachon (1969); *Pronoclituca acuta* (scale = 10  $\mu\text{m}$ ) redrawn from Schiller (1933); *Noctiluca scintillans* (scale = 500  $\mu\text{m}$ ) redrawn from Balech (1988a).

*Scaphodinium*. This noctiluroid family is characterized by width exceeding length due to anterioposterior compression or the presence of two wing-like extensions just below the cingulum; extension sometimes called vellum. Species lack a rotating hemispherical dome and tentacle. Species have encapsulated nucleus.

**Genus *Cymbodinium*** Cachon & Cachon 1967 (1 sp.)

**Type:** *C. elegans* Cachon & Cachon 1967.

**References:** Cachon & Cachon, 1967, 1969; Sournia, 1986; Fensome et al., 1993.

Unarmored. Large spherical to ovoid noctiluroid cell with a contractile velum initiating just below the premedian, incomplete cingulum. Transverse flagellum not in cingulum; located in flagellar tube. Rudimentary longitudinal flagellum.

***Cymbodinium elegans*** Cachon & Cachon 1967 (Plate 23)

**Distribution:** Mediterranean.

**Genus *Leptodiscus*** Hertwig 1877 (<5 spp.)

**Synonym:** *Pratjetella* Lohmann 1919.

**Type:** *L. medusoides* Hertwig 1877.

**References:** Cachon & Cachon, 1969; Sournia, 1986; Fensome et al., 1993.

Unarmored. Large noctiluroid, disk-shaped cell with prominent nucleus. *Gymnodinium* stages known. Movement similar to medusa.

***Leptodiscus medusoides*** Hertwig 1877 (not illustrated)

**Remarks:** Distinctive fragile species. In lateral view, cell is curved.

**Distribution:** Mediterranean.

**Family Noctiluaceae** Kent 1881

**Genus *Noctiluca*** Suriray 1836 (1 sp.)

**Type:** *N. scintillans* (Macartney) Kofoid & Swezy 1921.

**References:** Schiller, 1933; Cachon & Cachon, 1969; Zingmark, 1970; Soyer, 1970; Sournia, 1986; Sweeney, 1978; Fensome et al., 1993.

Unarmored. Large (200 to >1 mm), subspherical inflated vegetative cell with one flagellum and a striated tentacle. A ventral groove contains the flagellum, a tooth, and tentacle and is connected to a cytostome. The cytoplasm is vacuolate and can contain photosynthetic symbionts. Vegetative cell with eukaryotic nucleus. Gametes gymnodinioid; with dinokaryotic nucleus. Chloroplasts absent; phagotrophic. Forms blooms.

***Noctiluca scintillans*** (Macartney) Kofoid & Swezy 1921 (Plate 23)

**Remarks:** Distinctive species.

**Distribution:** Neritic; cosmopolitan in cold and warm water.

Genus *Pronoctiluca* Fabre-Domergue 1889 (<5 spp.)

Synonym: *Protodinifer* Kofoid & Swezy 1921

Type: *P. pelagica* Fabre-Domergue 1889.

References: Kofoid & Swezy, 1921; Steidinger & Williams, 1970; F. J. R. Taylor, 1976; Sournia, 1986; Fensome et al., 1993.

Small to medium-sized fusiform cell with premedian indistinct cingulum and anterior tentacle. Tentacle flexible and without cytoplasm. Sulcus exists on epitheca only. Anterior nucleus reported with condensed chromosomes. Chloroplasts absent.

Remarks: The taxonomic placement of this genus in the Pyrrhophyta has been questioned by Kofoid & Swezy (1921) and Fensome et al. (1993).

*Pronoctiluca acuta* (Lohmann) Schiller 1933 (Plate 23)

Distribution: Coastal and oceanic. Temperate and warm water; worldwide distribution.

Order Lophodinales Dodge 1984

References: Loeblich III, 1982; Fensome et al., 1993.

Unarmored freshwater species with a theca of many hexagonal vesicles not arranged in series except for the cingulum where there can be one or two rows of vesicles.

Remarks: Loeblich III (1982) considers this a family in the Peridinales and Fensome et al. (1993) place it in the Ptychodiscales.

Family Lophodiniaceae Osorio-Tafall 1941

Genus *Woloszynskia* Thompson 1951 (>5 spp.)

Synonym: *Aureodinium* Dodge, 1967.

Type: *W. reticulata* Thompson 1951.

References: Thompson, 1950; Crawford & Dodge, 1971; Crawford et al., 1970; Roberts & Timpano, 1989; Popovsky & Pfister, 1990.

Unarmored. Small to medium-sized cells of a gymnodinioid shape. Up to hundreds of detectable hexagonal vesicles; some species with fibrillar plate material in vesicles; plates not arranged in Kofoidian series. With or without apical groove. Contains chloroplasts, a nonmembrane bound stigma or eyespot, and other dinoflagellate organelles such as a pusule.

Remarks: A ventral ridge lies in the cingular and sulcal areas near the flagellar pores and contains fibrous material and may be homologous to the right sulcal plate in the Peridiniaceae. Species in this genus are found in brackish estuarine waters and can be identified as *Gymnodinium*, *Katodinium*, and *Amphidinium*, particularly those that are <15  $\mu\text{m}$ .

Order Brachydinales Loeblich III ex Sournia 1984

References: Loeblich III, 1982; Sournia, 1972, 1986; Fensome et al., 1993.



Unarmored pelliculate cell with four or five radiating elongate, flexible extensions; the anterior extension may be reduced. No sulcus observed.

**Remarks:** Fensome et al. (1993) place this group in the Ptychodiscales.

#### Family Brachydiniaceae Sournia 1972

**Genus *Brachydinium*** F. J. R. Taylor 1963 (<5 spp.)

**Type:** *B. capitatum* F. J. R. Taylor 1963.

**References:** F. J. R. Taylor, 1963; Sournia, 1972, 1986; Fensome et al., 1993.

Unarmored. Large, pelliculate cell with four radiating arms from hypotheca that are moveable; dorsoventrally flattened. Epitheca with apical process or reduced arm. Two flagella and an incomplete cingulum present. Ovoid nucleus occupies most of central body. Chloroplasts present.

***Brachydinium capitatum*** F. J. R. Taylor 1963 (Plate 24)

**Remarks:** Distinctive species.

**Distribution:** Mediterranean Sea.

#### Order Actiniscales Sournia 1984

**References:** Loeblich III, 1982; Sournia, 1986; Fensome et al., 1993.

Unarmored gymnodinioid cell type with internal skeletal elements. Where known, elements are siliceous.

**Remarks:** Loeblich III (1982) and Fensome et al. (1993) place this group in the Gymnodiniales.

#### Family Actiniscaceae Kützing 1844

**Genus *Actiniscus*** Ehrenberg 1841 (<5 spp.)

**Synonyms:** *Diaster* Meunier 1919; *Gymnaster* Schütt 1891.

**Type:** *A. pentasterias* (Ehrenberg) Ehrenberg 1854.

**References:** Bursa, 1969; Steidinger & Williams, 1970; Sournia, 1986; Larsen & Sournia, 1991; Hansen, 1993.

Unarmored. Small gymnodinioid cell with siliceous internal skeleton of two star-shaped pentasters surrounding the nucleus. Cingulum median and descending about one cingulum width. Sulcus slightly indents the epitheca. Chloroplasts absent, but with other typical dinophycean organelles.

**Remarks:** It is not known whether representatives of this genus have an apical groove.

***Actiniscus pentasterias*** (Ehrenberg) Ehrenberg 1854 (Plate 24)

**Distribution:** Subtropical to cold temperate in oceans even as marine relics in freshwater arctic lakes.

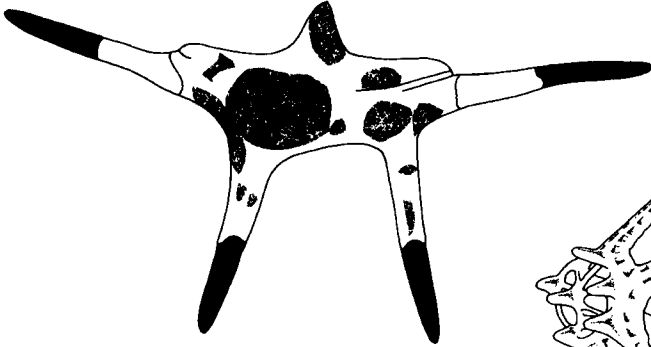

*Brachydinium capitatum* —

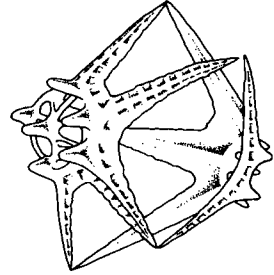

*Actiniscus pentastereus*

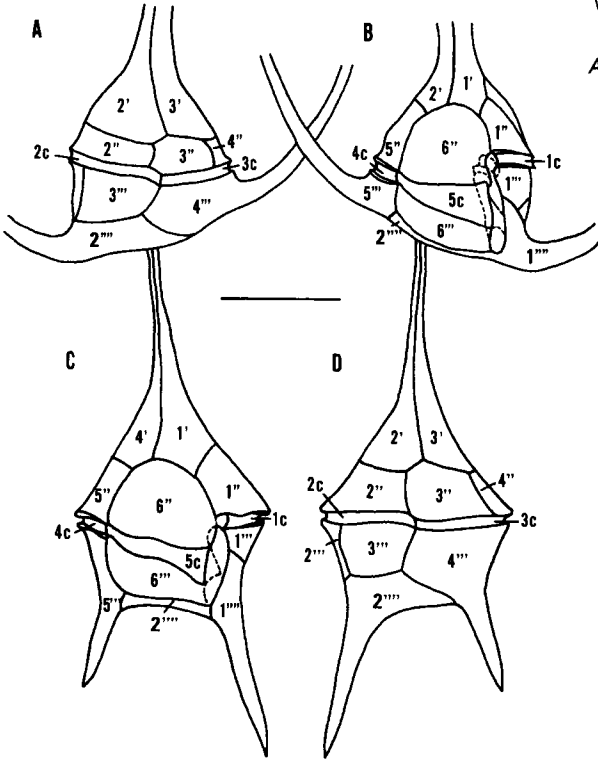

schematic *Ceratium*

PLATE 24 *Brachydinium capitatum* (scale = 10  $\mu$ m) redrawn from Sournia (1972); *Actiniscus pentastereus*; schematic *Ceratium* redrawn from Evitt and Wall (1975) (B and C are ventral views, A and D are dorsal views).

**Order Gonyaulacales** F. J. R. Taylor 1980

**References:** F. J. R. Taylor, 1980, 1987; Loeblich III, 1982; Dodge, 1982, 1989; Sournia, 1986; Fensome et al., 1993.

Armored gonyaulacoid type cell with asymmetrical plate pattern with an APC that typically lacks the x or canal plate of the peridinioids. Plate tabulation is usually 3 or 4', variable anterior intercalary tabulation, 5–7" but typically 6", 5 or 6c but typically 6c, 5 or 6'" but typically 6'", and 1–3''' but typically 2''', 0 or 1p, but typically 0p. The 1' is usually asymmetric.

**Remarks:** Loeblich III (1982) and Sournia (1986) place this group in the Peridinales. *Pyrophacus* is clearly an exception and there are at least six genera that probably belong in another order: *Crypthecodinium*, *Heterodinium*, *Coolia*, *Ostreopsis*, *Fragilidium*, and *Pyrophacus*.

**Family Ceratiaceae** Lindemann 1928

**Genus** *Ceratium* Schrank 1793 (<125 spp.)

**Type:** *C. pleuroceras* Schrank 1793.

**References:** Jörgensen, 1911, 1920; Lebour, 1925; Schiller, 1937; Graham & Bronikovsky, 1944; Hasle & Nordli, 1951; Nordli, 1957; von Stosch, 1964; Lopez, 1966; Margelef, 1967; Sournia, 1967b, 1986; Yarranton, 1967; Subrahmanyam, 1968; Steidinger & Williams, 1970; F. J. R. Taylor, 1976; Rampi & Bernhard, 1980; Dodge, 1982; Balech, 1988; Delgado & Fortuño, 1991; Fensome et al., 1993.

Armored. Small to large cells over 1 mm. Gonyaulacoid body with two to four hollow horns; horns open or closed. Central body somewhat dorsoventrally compressed. Surface smooth with pores to highly reticulate. Chloroplasts present; cells sometimes with food vacuoles due to phagocytic activity. Plate formula: Po, cp, 4', 6", 5c, 2+s, 6'", 2'''. Cingulum slightly descending. The ventral side of the central body has a depressed area referred to as the ventral area. It consists of three hyaline plates, 6", 5c, and 6'''. Sulcus located to left of ventral area and modified to a trough. The apical horn is formed by the apical plates; antapical or hypothecal horns are formed by postcingular and antapical plates. Right hypothecal horn is formed by postcingulars. Left hypothecal horn is formed by antapicals.

**Remarks:** Fensome et al. (1993) call the antapical or hypothecal horns either a postcingular horn or an antapical horn based on their interpretation of plates that form the horns. Species in this genus are differentiated on the following characters: the presence or absence of an apical horn; the presence of inflated epitheca; development, direction, and curvature of horns; relation of left and right hypothecal horns; hypothecal horns with open or closed ends; total length of cell; shape and width of body; epitheca in relation to

hypotheca; cell contour; and surface markings. The best view for cell outline and horn curvature and direction is a dorsal view. **Plates 31–33** have silhouettes of *Ceratium* species in dorsal view. Compare them with their ventral view counterparts in **Plates 25–29** and visualize how the preceding characters can be used to differentiate species. Some species have been documented to produce anisogametes. The smaller or male gamete often does not resemble the vegetative stage and can be misidentified as another species, such as *C. lineatum*, or similar species with posteriorly directed hypothecal horns.

***Ceratium arcticum*** (Ehrenberg) Cleve 1901 (**Plate 26**)

Large *C. horridum*-like cell with apical horn directed to the right.

Hypothecal horns open distally, slightly curved and directed outward from the body; not substantially curved below the straight posterior body margin.

**Remarks:** Similar to *Ceratium longipes*.

**Distribution:** Cold water species; North Atlantic and North Pacific Oceans, and Arctic Ocean.

***Ceratium arietinum*** Cleve 1900 (**Plate 27**)

**Synonym:** *C. bucephalum* Cleve, 1897.

Large *C. tripos*-like cell with rounded epithecal shoulders and slightly offset apical horn. Hypothecal horns curved and attenuated; ends closed.

Curvature gentle and almost equal distant from apical horn; right horn longer. Surface with pores.

**Distribution:** Neritic, oceanic; warm temperate to tropical waters; worldwide distribution.

***Ceratium candelabrum*** (Ehrenberg) Stein 1883 (**Plate 26**)

Large *C. furca*-like cell with body wider than long. Epithecal shoulders angularly tapering into straight, offset apical horn. Hypothecal horns divergent and directed posteriorly beyond posterior margin; left horn longer and often serrated. Surface with pores; sometimes with thecal flanges. Can form chains. Several varieties.

**Distribution:** Oceanic; warm temperate to tropical waters; worldwide distribution.

***Ceratium carriense*** Gourret 1883 (**Plate 29**)

Largest *C. massiliense*-like cell with slightly offset but straight apical horn formed from rounded epitheca. Left hypothecal horn gently or broadly curves from body and distal end (open) is directed anteriorly. Right horn curves proximally and then is directed to right. Several varieties.

**Distribution:** Oceanic; warm temperate to tropical waters; worldwide distribution.

***Ceratium contortum*** (Gourret) Cleve 1900 (Plate 27)

**Synonym:** *C. arcuatum* (Gourret) Cleve.

Large *C. tripos*-like cell with offset apical horn directed to right. Right hypothecal horn curved and bent or recurved past apical horn. Horns attenuated, closed ends. Posterior body margin straight or slightly rounded. Several varieties.

**Remarks:** Highly variable species; see Sournia (1967).

**Distribution:** Oceanic and coastal. Cosmopolitan in warm temperate to tropical waters; worldwide distribution.

***Ceratium declinatum*** (Karsten) Jörgensen 1911 (Plate 26)

Large *C. tripos*-like cell with epitheca that abruptly forms an apical horn. The left epithecal shoulder is almost straight; right shoulder is rounded. Posterior body margin is rounded. Curved hypothecal horns (closed) reach anteriorly just beyond epithecal body; right horn longer. Several varieties.

**Distribution:** Oceanic; temperate to tropical waters; worldwide distribution.

***Ceratium furca*** (Ehrenberg) Claparède & Lachmann 1859 (Plate 25)

Large species with two unequal, parallel or slightly divergent hypothecal horns; right horn shorter than left. Hypothecal horns serrated. Epitheca gradually tapers into apical horn.

**Remarks:** Sometimes confused with *C. hircus* even though *C. hircus* is smaller, restricted to estuarine/coastal warm waters, and has almost equal hypothecal horns and a more robust body. The right hypothecal horn of *C. hircus* is directed ventrally. *C. hircus* is dark brown to brown-yellow in the living state and *C. furca* is typically more yellow than brown.

**Distribution:** Principally coastal, but found in estuarine and oceanic environments; cosmopolitan in cold temperate to tropical waters.

***Ceratium fusus*** (Ehrenberg) Dujardin 1841 (Plate 25)

Large fusiform cell with a fully developed apical horn, a fully developed left hypotheca horn, and a rudimentary right hypothecal horn. Left horn slightly curved to straight. Epitheca tapers gently into slightly curved apical horn. Surface with linear markings.

**Remarks:** Similar to *C. extensum* which is considerably larger (>1 mm) with a long, straight left hypothecal horn.

**Distribution:** Oceanic to estuarine; principally coastal. Cosmopolitan in cold temperate to tropical waters.

***Ceratium gibberum*** Gourret 1883 (Plate 27)

Large *C. tripos*-like cell with offset straight apical horn and angular right epithecal shoulder. Hypothecal horns (closed) curved and directed anteriorly or right horn recurved past apical horn. Posterior body margin

Ceratium

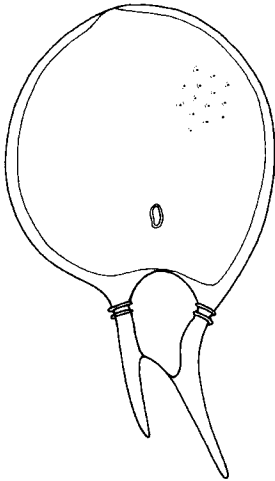

*C. gravidum*

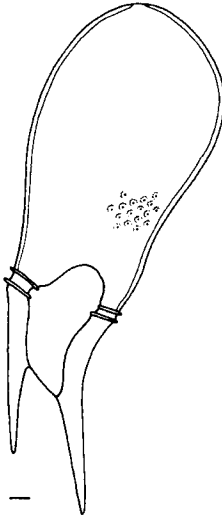

*C. praelongum*



*C. fusus*

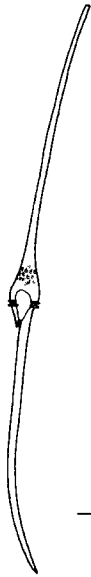

*C. inflatum*

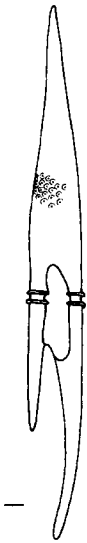

*C. incisum*

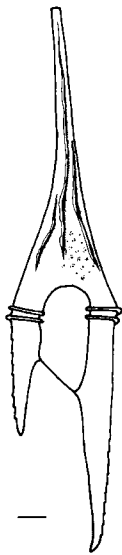

*C. furca*

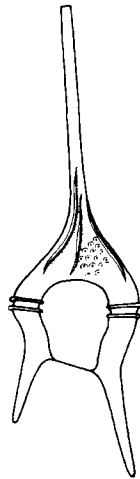

*C. lineatum*

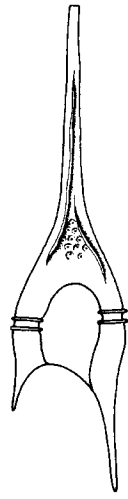

*C. kofoidii*

PLATE 25 Scale = 10  $\mu$ m unless otherwise indicated. *Ceratium gravidum*, *C. praelongum*, *C. fusus*, *C. inflatum* (scale = 100  $\mu$ m), *C. incisum*, *C. furca*, *C. lineatum*, and *C. kofoidii*.

rounded and body hypotheca exceeds epitheca. Surface with pores; rugose.

**Remarks:** Can be confused with *C. concilians* which has proximally bent apical horn and rounded right epithecal shoulder. *C. concilians* is less reticulate.

**Distribution:** Oceanic and coastal. Warm temperate to tropical waters; worldwide distribution.

***Ceratium gravidum*** Gourret 1883 (Plate 25)

Lacks apical horn. Epitheca rounded to spatula like; dorsoventrally flattened. Epitheca with ventral ring pore. Hypotheca narrow and straight extending into hypotheca horns; left horn curved and longer than right. Surface with pores.

**Distribution:** Oceanic; tropical waters; worldwide distribution.

***Ceratium hexacanthum*** Gourret 1883 (Plate 27)

Large *C. tripos*-like cell with distinctive surface reticulation pattern. Hypothecal horns can be recurved and twisted. Several varieties.

**Distribution:** Coastal and oceanic. Cosmopolitan in cold temperate to tropical waters, but more common in warm water.

***Ceratium horridum*** (Cleve) Gran 1902 (Plate 28)

Large cell with triangular epitheca that abruptly forms apical horn directed to right. Hypothecal horns (open) level with straight posterior body margin. Right horn almost parallel with apical horn. Surface with linear markings. Several varieties.

**Remarks:** Variable species, see Sournia (1967).

**Distribution:** Coastal and oceanic. Cold to warm temperate waters, but has been recorded in tropical waters; worldwide distribution.

***Ceratium incisum*** (Karsten) Jørgensen 1911 (Plate 25)

Large *C. furca*-like cell with epitheca steeple shaped, tapering into apical horn. Hypotheca with two horns; left longer than right. Right horn straight, left horn curved on inner surface. Posterior body margin V shaped, not U shaped as in others of the *furca* group.

**Distribution:** Oceanic. Warm temperate to tropical waters; worldwide distribution.

***Ceratium inflatum*** (Kofoid) Jørgensen 1911 (Plate 25)

Large (up to 1 mm) *C. fusus*-like cell with inflated epitheca that abruptly forms apical horn. Left hypothecal horn bent distally.

**Distribution:** Oceanic; warm temperate to tropical waters; worldwide distribution.

***Ceratium kofoidii* Jørgensen 1911 (Plate 25)**

Large, delicate *C. furca*-like cell with triangular epitheca abruptly forming apical horn. Hypothecal horns needle shaped, serrated, and parallel to slightly divergent. Surface with linear markings.

**Distribution:** Oceanic; warm temperate to tropical waters.

***Ceratium limulus* Gourret 1883 (Plate 28)**

Large *C. tripos*-like cell of condensed form. Short straight apical horn sitting on angled and humped epithecal shoulders. Hypothecal horns (closed) nearly symmetrical and left closely appressed to body. Posterior body margin rounded. Surface rugose.

**Remarks:** Can be confused with *C. paradoxides* which is smaller and has an apical horn directed to the right. Also, the hypothecal horns of *C. paradoxides* are away from the body.

**Distribution:** Oceanic. Warm water species; worldwide distribution.

***Ceratium lineatum* (Ehrenberg) Cleve 1899 (Plate 25)**

Medium-sized *C. furca*-like cell with apical horn formed from triangular epitheca and directed to the right. Hypothecal horns (closed ends) divergent and directed posteriorly beyond posterior body margin. Left horn longer. Body shape narrowly pentagonal. Surface with pores and linear markings.

**Remarks:** This species can be confused with *C. pentagonum* and similar species.

**Distribution:** Neritic, oceanic; cold temperate to tropical waters. There may be distinct warm water forms.

***Ceratium longipes* (Bailey) Gran 1902 (Plate 26)**

Large *C. horridum*-like cell with open hypothecal horns. Epitheca tapers into an apical horn that is bent to the right. Hypothecal horns (open) are level with the straight posterior body margin. Several forms.

**Remarks:** This is a variable species and is very similar to *C. horridum*.

**Distribution:** Coastal. Arctic to cold temperate waters.

***Ceratium lunula* (Schimper) Jørgensen 1911 (Plate 29)**

Large robust cell sometimes with symmetrical hypothecal horns (closed). Epitheca triangular abruptly forming straight apical horn. Hypothecal horns parallel with straight posterior body margin. Right horn curved but directed to right.

**Distribution:** Coastal and oceanic. Warm temperate to tropical waters; worldwide distribution.

***Ceratium macroceros* (Ehrenberg) Vanhöffen 1897 (Plate 29)**

Large *C. massiliense*-like cell with angular box-like body that abruptly forms an offset apical horn directed to the right. Left and right



Ceratium

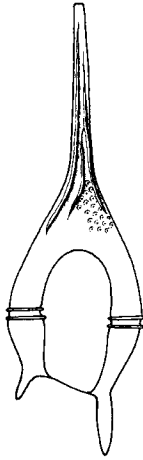

*C. teres*

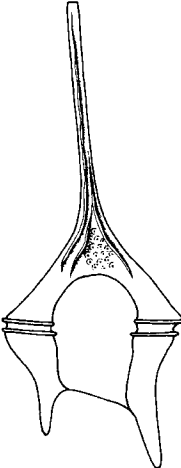

*C. penatogonum*

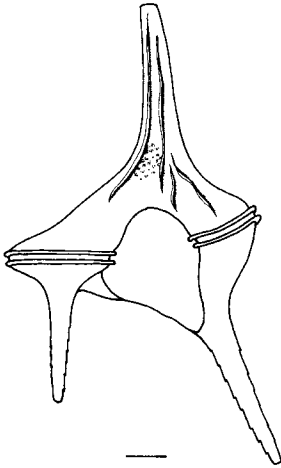

*C. candelabrum*

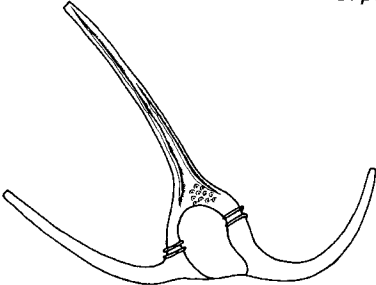

*C. longipes*

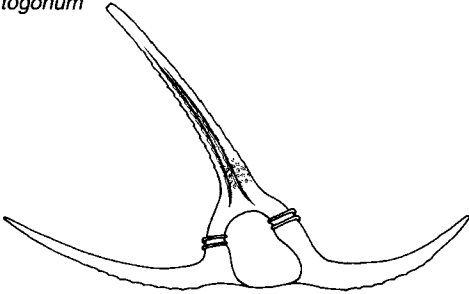

*C. arcticum*

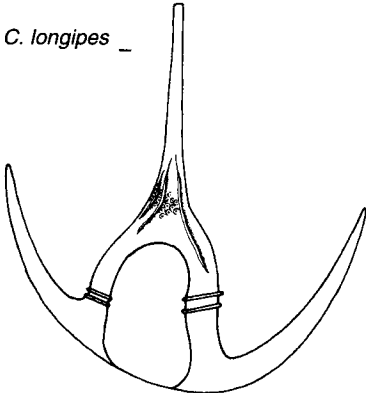

*C. tripos*

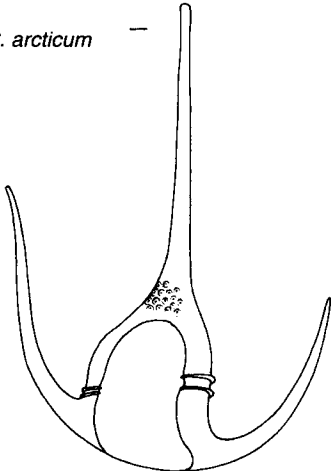

*C. declinatum*

hypothecal horns (open ended) proximally of same width and formed abruptly from body; extend beyond straight posterior body margin almost equally before curving or bending. Left horn curves anteriorly; right horn bends to the right and almost parallels the apical horn.

**Remarks:** Can easily be confused with *C. massiliense*, but the hypothecal horn development and the right-directed apical horn clearly distinguish it.

**Distribution:** Oceanic and coastal. Cold temperate to tropical waters; worldwide distribution.

***Ceratium massiliense*** (Gourret) Jørgensen 1911 (Plate 33)

Large cell with rounded epitheca and apical horn slightly directed to the right. Typical diagonal straight posterior body margin that makes proximal end of left horn wider than that of the right horn. Left horn curves and is almost immediately directed anteriorly. Right horn bends and is directed to the right. Hypothecal horns with open ends.

**Distribution:** Coastal and oceanic. Cosmopolitan in warm temperate to tropical waters.

***Ceratium pentagonum*** Gourret 1883 (Plate 26)

Large *C. furca*-like cell with broad pentagonal central body. Epithecal shoulders angular and abruptly forming straight apical horn. Hypothecal horns almost parallel; extend beyond posterior margin. Apical horn can be short or long. Surface with raised ornamentation. Several varieties.

**Distribution:** Oceanic, warm temperate to tropical waters; worldwide distribution.

***Ceratium platycorne*** Daday 1888 (Plate 30)

Large *C. horridum*-like cell with characteristic inflated hypothecal horns (open); horns almost symmetrical. Surface with pores and lists; horns serrated at margins.

**Distribution:** Oceanic. Warm water species.

***Ceratium praelongum*** (Lemmermann) Kofoid 1907 (Plate 25)

Large cell without apical horn but with expanded epitheca that is spatula like. Epitheca dorsoventrally flattened with ventral ring pore. Proximal hypotheca same width as epitheca and extending into two parallel hypothecal horns (closed ends). Surface with pores.

**Distribution:** Oceanic; tropical waters; worldwide distribution.

***Ceratium pulchellum*** Schröder 1906 (Plate 27)

Large delicate *C. tripos*-like cell with long straight apical horn and short hypothecal horns (closed). Posterior body margin rounded. Right hypothecal horn extends about two or three girdle widths and can be close to the body. Left horn is slightly curved and reaches as high as the cingulum.

**Distribution:** Oceanic. Subtropical to tropical waters; worldwide distribution.

***Ceratium ranipes*** Cleve 1900 (Plate 30)

Large *C. horridum*-like cell with characteristic finger-like extensions from hypothecal horns (open). Apical horn directed to right. Horns partially serrated along margins.

**Distribution:** Oceanic. Warm temperate to tropical waters; worldwide distribution.

***Ceratium symmetricum*** Pavillard 1905 (Plate 28)

Large *C. tripos*-like cell with rounded epithecal shoulders and straight apical horn. Hypothecal horns almost equal distance from apical horn and symmetrical; horns attenuated with closed ends. Hypothecal horns can approach length of apical horn. Posterior body margin rounded. Surface with pores and fine markings.

**Distribution:** Warm temperate to tropical waters; worldwide distribution.

***Ceratium teres*** Kofoid 1907 (Plate 26)

Large, delicate *C. furca*-like cell with characteristic hypothecal horns. Triangular epitheca with slightly rounded shoulders abruptly forming straight apical horn. Hypothecal horns short and slightly swollen in middle; left longer than right. Surface with pores.

**Distribution:** Oceanic; warm temperate to tropical waters, but rare; worldwide distribution.

***Ceratium trichoceros*** (Ehrenberg) Kofoid 1908 (Plate 29)

Large, delicate *C. massiliense*-like cell with characteristic horn development. Apical and hypothecal horns (open ends) in parallel plane.

**Distribution:** Coastal and oceanic. Cosmopolitan in warm temperate to tropical waters; worldwide distribution.

***Ceratium tripos*** (O. F. Müller) Nitzsch 1817 (Plate 26)

Large cell with triangular epitheca that abruptly forms straight apical horn. When hypothecal horns (closed) well developed, almost parallel with apical horn. In other forms, right horn can be directed to the right. Surface with linear markings; rugose.

**Remarks:** Variable species, see Sournia (1967).

**Distribution:** Coastal and oceanic. Cosmopolitan in cold temperate to tropical waters; worldwide distribution.

Ceratium

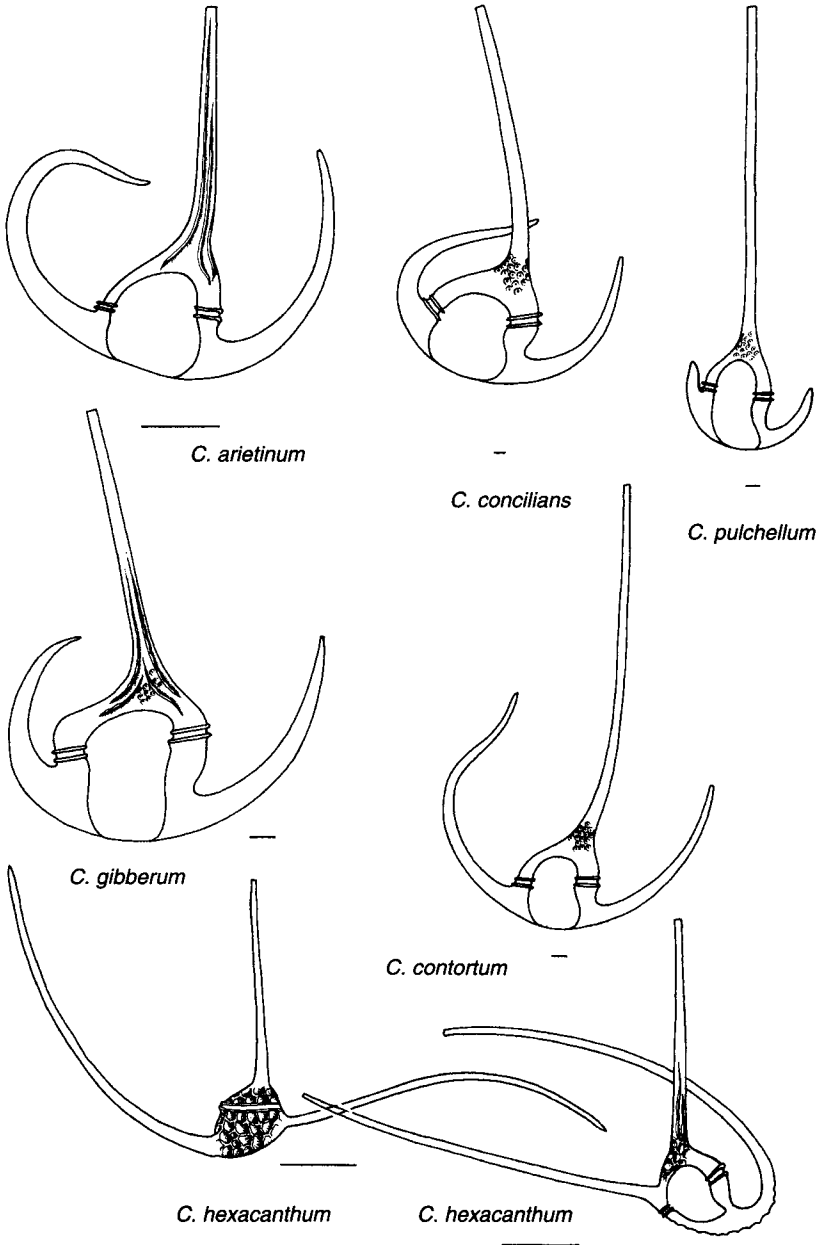
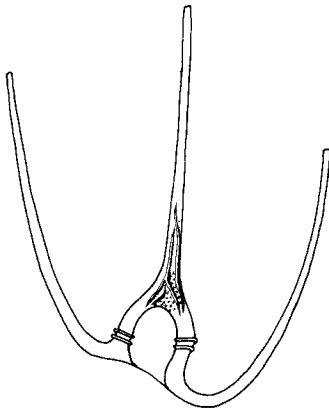
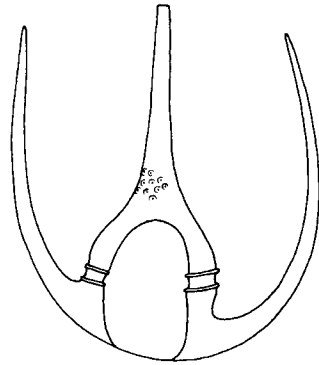

PLATE 27 Scale = 10  $\mu\text{m}$  unless otherwise indicated. *Ceratium arietinum*, *C. concilians*, *C. pulchellum*, *C. gibberum*, *C. contortum*, and *C. hexacanthum* (scale = 100  $\mu\text{m}$ ).

Ceratium



*C. horridum*



*C. symmetricum*

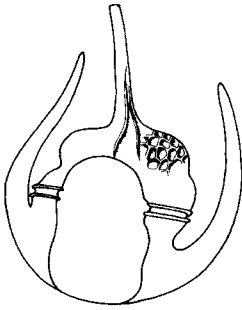

*C. paradoxides*

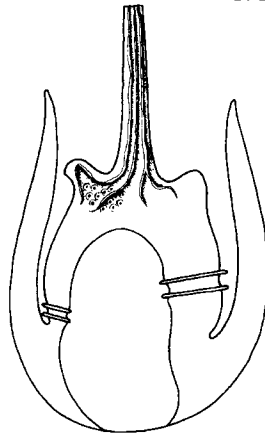

*C. limulus*

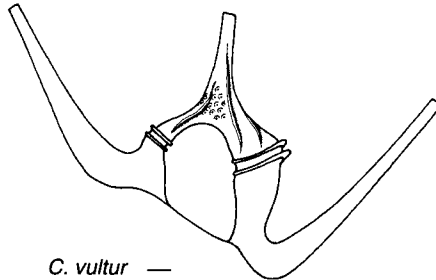

*C. vultur*

PLATE 28 *Ceratium horridum*, *C. symmetricum*, *C. paradoxides*, *C. limulus*, and *C. vultur*.  
Scale = 10  $\mu$ m.

Ceratium

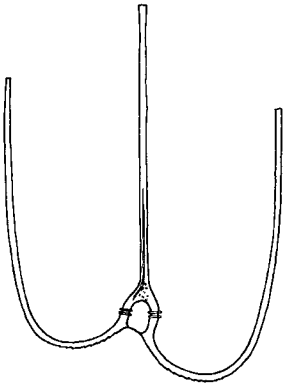

*C. trichoceros*

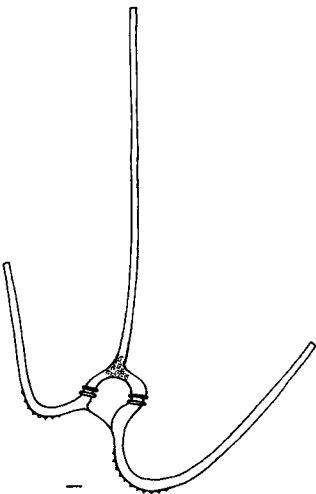

*C. macroceros*

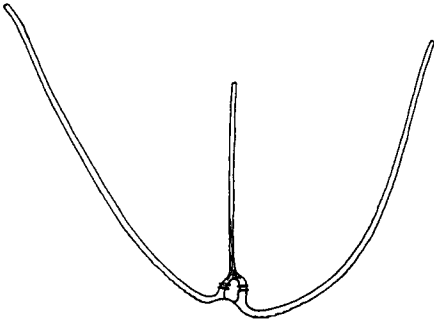

*C. carriense*

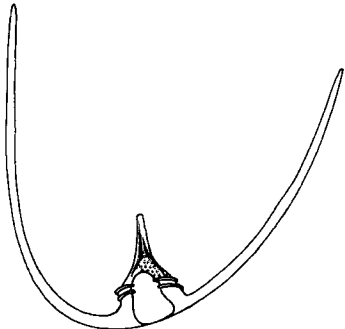

*C. lunula*

PLATE 29 Scale = 100  $\mu$ m unless otherwise indicated. *Ceratium trichoceros*, *C. macroceros* (scale = 10  $\mu$ m), *C. carriense*, and *C. lunula*.

***Ceratium vultur* Cleve 1900 (Plates 6 and 28)**

Large robust single cell and chain-forming varieties. Epitheca tapers into straight apical horn. Hypothecal horns (closed) well developed. Left horn curved beyond straight posterior body margin; right forms parallel to margin and bends abruptly upward and to right or bends beyond posterior margin and is directed outwardly.

**Distribution:** Oceanic. Warm temperate to tropical waters; worldwide distribution.

**Family Ceratocoryaceae Lindemann 1928****Genus *Ceratocorys* Stein 1883 (<10 spp.)**

**Type:** *C. horrida* Stein 1883.

**References:** Schiller, 1937; Graham, 1942; Steidinger & Williams, 1970; F. J. R. Taylor, 1976; Loeblich III, 1982; Sournia, 1986; Fensome et al., 1993.

Armored. Medium-sized cell of angular to round shape with characteristic short- or long-winged spines (two to eight) that can originate posteriorly from the antapical plate and ventrally or dorsally from postcingular plates. Posterior spines associated with antapical plate. Hypotheca exceeds epitheca and can be compressed laterally. Theca robust with prominent areolae. Cingulum premedian and displaced 0.5–2.5 $\times$ . Cingular lists supported by prominent spines. Plate formula: Po, 3', 1a, 5'', 6c, 10s, 5''', and 1'''. Chloroplasts present.

**Remarks:** Apical pore plate very distinct and not like *Goniodoma* (Plate 3). Po has linear slit in an elongate nontriangular plate. *Goniodoma* and *Alexandrium* have a comma-shaped closing plate, or what Balech calls a canopy, covering the pore. Graham (1942) reported a ventral pore in 1', distally and to the right.

***Ceratocorys horrida* Stein 1883 (Plate 30)**

Winged hypothecal spines with distal barbs. Some spines as long as depth of body; spines originating from antapical and postcingular plates.

**Distribution:** Oceanic, neritic; warm temperate to tropical waters; worldwide distribution.

***Ceratocorys armata* (Schütt) Kofoid 1910 (Plates 3 and 30)**

Four short-winged spines originating from the antapical plate.

**Distribution:** Subtropical to tropical waters; worldwide distribution.

**Family Cladopyxidaceae Stein 1883 emend. Balech 1967****Genus *Cladopyxis* Stein 1883 (<5 spp.)**

**Type:** *C. brachiolata* Stein 1883.

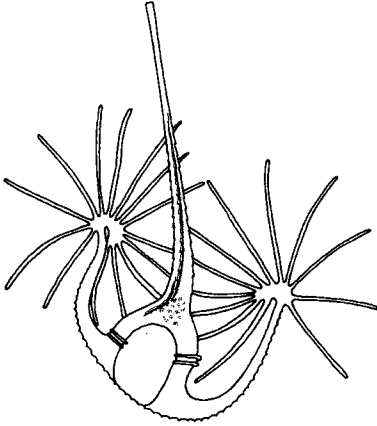

*Ceratium ranipes*

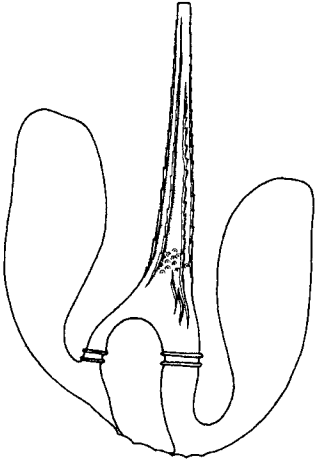

*Ceratium platycorne*

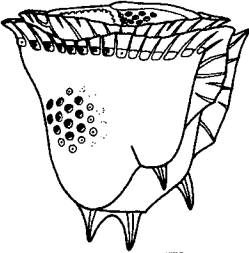

*Ceratocorys armata*

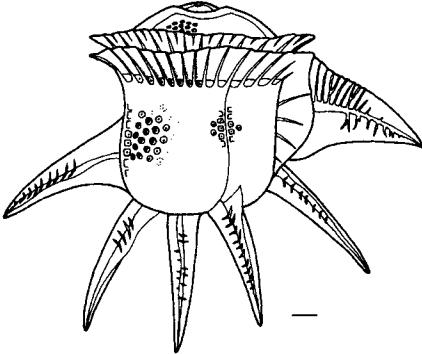

*Ceratocorys horrida*

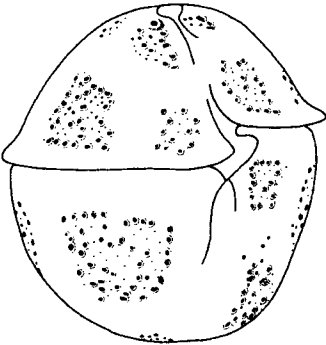

*Palaeophalacroma uninctum*

PLATE 30 *Ceratium ranipes*, *C. platycorne*, *Ceratocorys armata*, *C. horrida*, and *Palaeophalacroma uninctum*. Scale = 10  $\mu$ m.



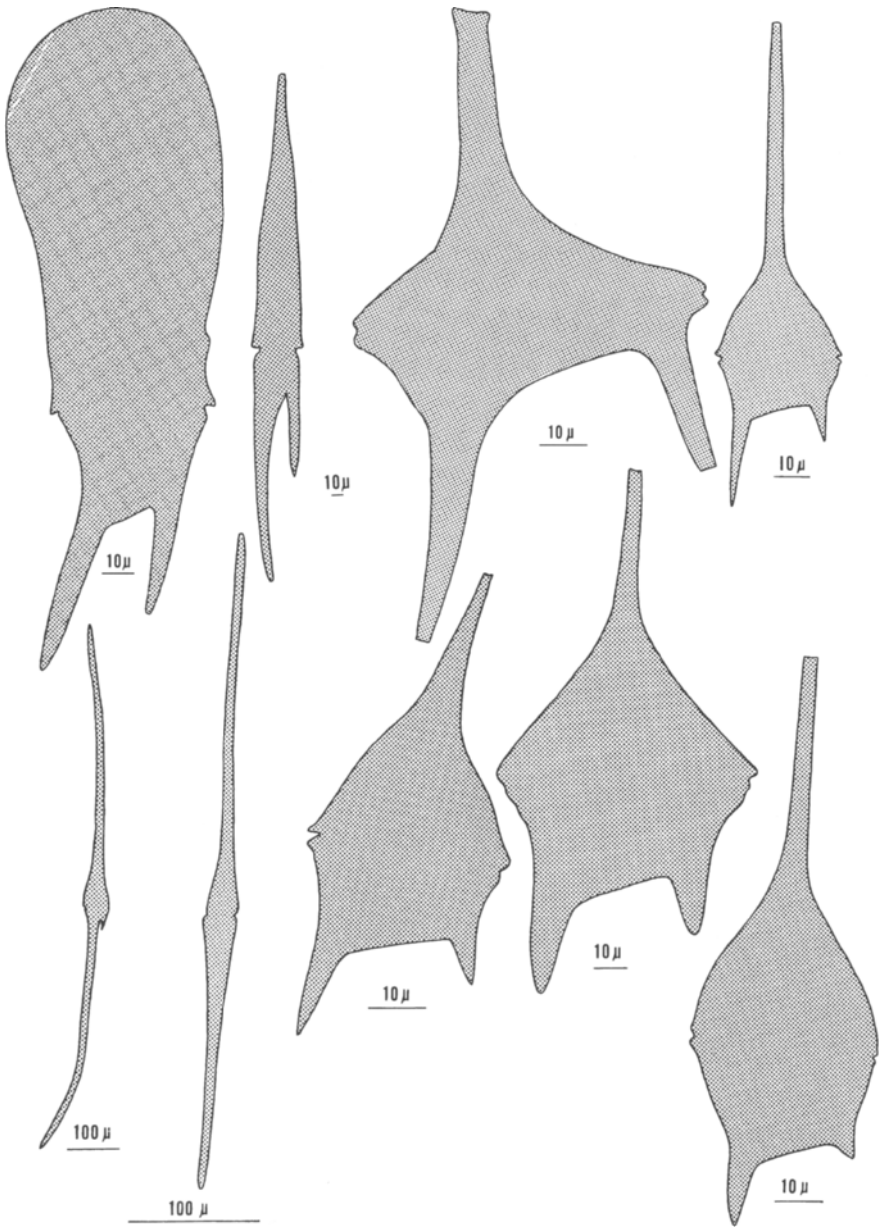

PLATE 31 Silhouettes of *Ceratium* species for comparison of size and shape.

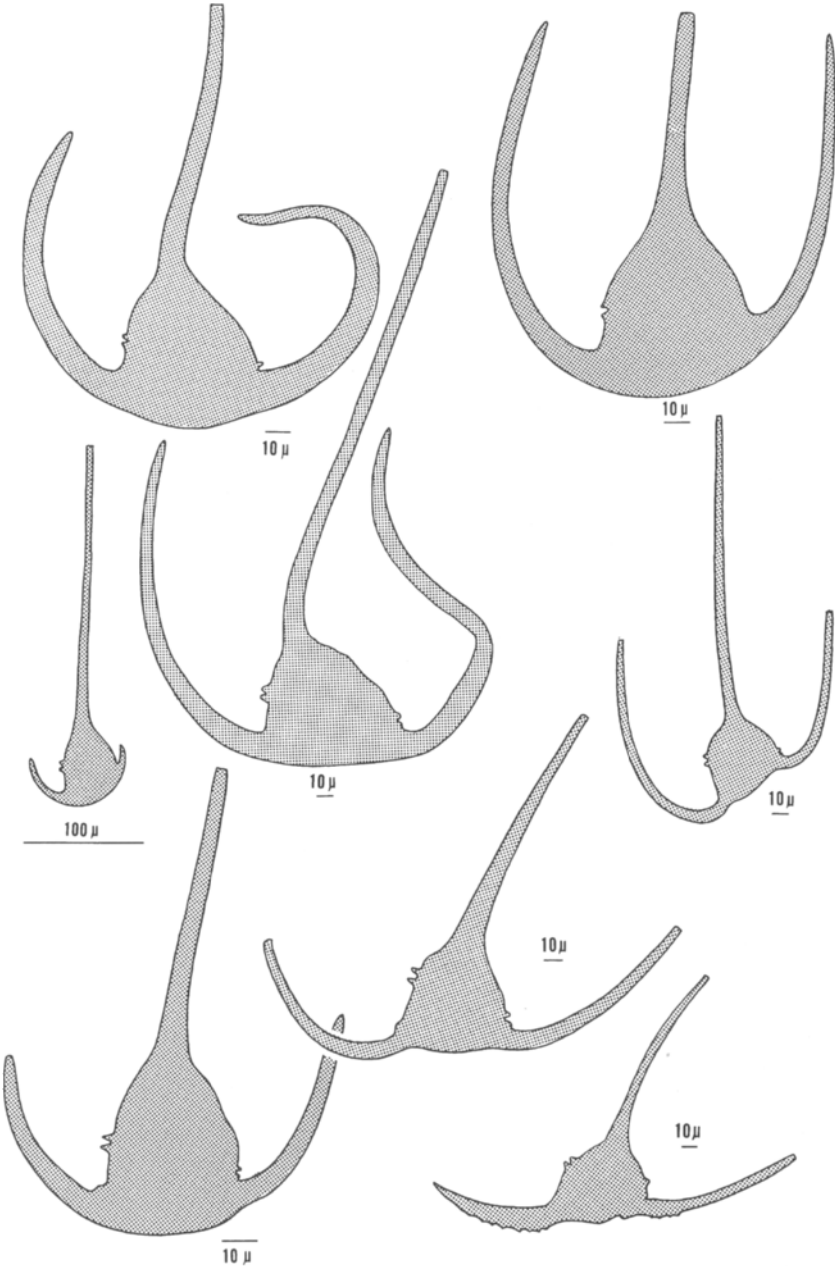

PLATE 32 Silhouettes of *Ceratium* species for comparison of size and shape.

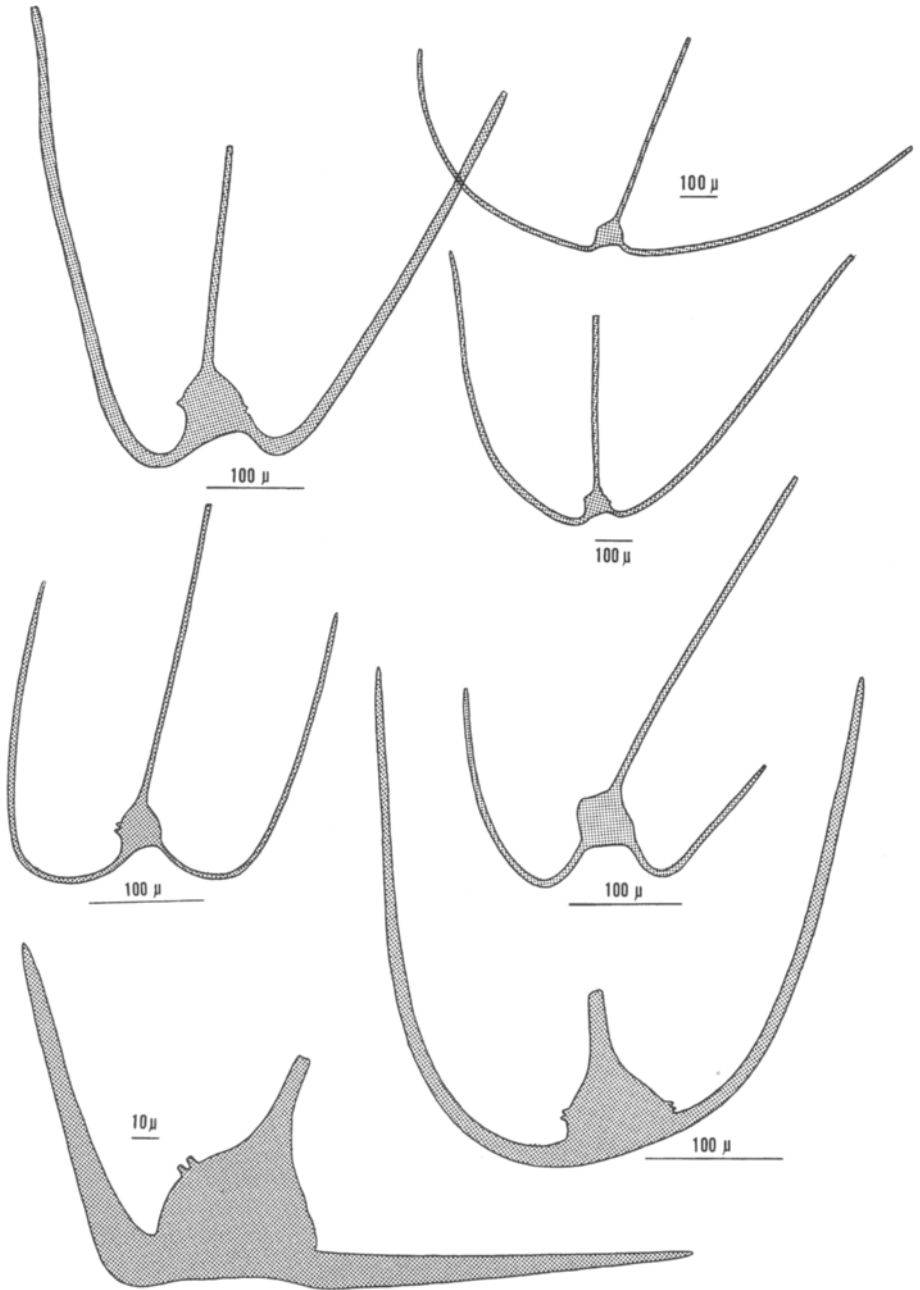

PLATE 33 Silhouettes of *Ceratium* species for comparison of size and shape. Top left drawing represents a dorsal view of *C. massiliense*, its ventral view is not illustrated in **Plate 29**.

**References:** Balech, 1964a, 1967; Schiller, 1937; Loeblich III, 1982; Sournia, 1986; Below, 1987b.

Armored. Cell small to medium sized and round to oval with characteristic thick extensions (arms) that can be pointed or furcated at the tip. Typically, between 3 and 12 arms are present. Extensions are similar to the hystrichospherid fossil dinoflagellate extensions. Theca with pores. Cingulum is premedian and only slightly displaced. Plate formula: Po, 3', 3a, 7", 6c, 7s, 6'", and 2'''. The sa has been interpreted as the 1' on some occasions. Chloroplasts present.

**Remarks:** This genus is closely related to *Paleocephalacroma*.

*Cladopyxis brachiolata* Stein 1883 (not illustrated)

Cell small to medium sized with 10 strongly developed furcated arms on plates 3–6", 2'", 3–6'", and 1–2'''.

**Remarks:** Compare to *Palaeocephalacroma*.

**Distribution:** Oceanic; tropical and warm temperate waters of oceans and seas.

**Genus *Palaeocephalacroma*** Schiller 1928 (>5 spp.)

**Synonyms:** *Epiperidinium* Gaarder 1954; *Sinodinium* Nie 1945.

**Type:** *P. verrucosum* Schiller 1928.

**References:** Balech, 1967; Loeblich III, 1982; Dodge, 1982; Sournia, 1986; Below, 1987.

Armored. Cell small, subspherical. Cingulum premedian, descending, about 1X. Anterior cingular list present, posterior list absent. Sulcus not excavated. Theca with large and small pores. Plate formula: Po, 4', 3a, 7", 6c, 6s, 6'", and 2'' ". 1' narrow as in *Gonyaulax*. Chloroplasts usually present.

*Paleocephalacroma uncinatum* Schiller 1928 (Plates 7 and 30)

Small ovoid cell with numerous chloroplasts and a centrally located nucleus.

**Distribution:** Tropical and warm temperate oceans.

**Family Crypthecodiniaceae** Biecheler 1952

**Genus *Crypthecodinium*** Biecheler 1938 (<5 spp.)

**Type:** *C. setense* Biecheler 1938.

**References:** Biecheler, 1952; Javornicky, 1962; Kubai & Ris, 1969; Loeblich III, 1982; Sournia, 1986; Beam & Himes, 1987; Fensome et al., 1993.

Armored. Cell small and spherical to ovoid with thin thecal plates in a modified Kofoidian series. The cingulum is descending and incomplete; the distal end does not meet the sulcus. Species are phagocytic and have a peduncle; chloroplasts absent. Forms immobile reproductive cysts. Plate

formula: 4', 3a, 5", 6c, 5s, 5' ", 3 ""', and an x plate in the right hypotheca adjacent to the end of the cingulum.

**Remarks:** Genus aptly named; however, there are several genera with thin thecae. The plate pattern with the X plate is unique.

*Crypthecodinium cohnii* (Seligo) (Plate 34)

**Remarks:** Reported to have 52 sibling species, 7 major and 45 that were only found once.

**Distribution:** Brackish to marine, littoral; found associated with decaying macroalgae from the North Sea to the Caribbean.

Family Goniodomataceae Lindemann 1928

Genus *Alexandrium* Halim 1960 (>30 spp.)

**Synonyms:** *Gonyaulax* Diesing 1866; *Pyrodinium* Plate 1906; *Gessnerium* Halim 1967 ex Halim 1969; *Protogonyaulax* Taylor 1979.

**Type:** *A. minutum* Halim 1960. The type species for the *Gessnerium* subgenus is *A. (Gessnerium) monilatum* (Howell) Loeblich III 1970.

**References:** Lebour, 1925; Whedon & Kofoid, 1936; Halim, 1960a; Steidinger, 1971, 1990, 1993; F. J. R. Taylor, 1975, 1979, 1984; Schmidt & Loeblich, 1979; Dale, 1983; Balech, 1985a, 1989, 1990a, b, 1992a, 1993, 1994, 1995; Balech & Tangen, 1985; Kita & Fukuyo, 1988; Larsen & Moestrup, 1989; Steidinger & Moestrup, 1990; Hallegraeff, 1991; Fensome et al., 1993.

This genus has extensive synonymy due to continual scrutiny of toxic species causing public health, economic, and ecological problems. The genus is composed of two related subgenera: *Alexandrium* and *Gessnerium*. *Alexandrium*: armored. Cells typically spherical to hemispherical to oval to slightly biconical, but without horns or spines. Plate formula: Po, cp, 4', 0a, 6", 6c, 9 or 10s, 5' ", and 2"". Descending median cingulum without overhang or contortion, displaced 1–1.5 girdle widths. Surface markings include pores, reticulae, and vermiculae. Thecae can be thin and delicate to rugose. Cytoplasm includes elongate to C-shaped nucleus and all species contain chloroplasts. In this subgenus, the Po touches the 1', but the connection is sometimes obscured in older cells with plate overlap growth of 2' and 4'. Also, in some species of the

---

PLATE 34 *Crypthecodinium cohnii* (scale = 5  $\mu$ m) redrawn from Biecheler (1952); schematic of *Alexandrium* with ventral, apical, and antapical views, apical pore complex and 1', and sulcal plates. sa, anterior sulcal; sma, median anterior sulcal; ssa, accessory left sulcal; smp, posterior median sulcal; ssp, posterior left sulcal plate; sp, posterior sulcal; sdp, posterior right sulcal; sacp, posterior accessory sulcal; sda, anterior right sulcal; saca, anterior accessory sulcal. Redrawn from Balech (personal communication).

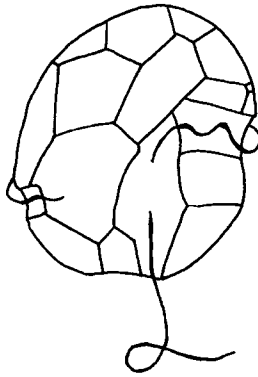

*Crypthecodinium cohnii*

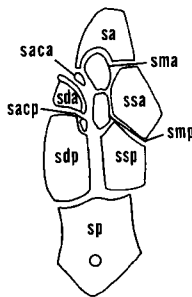
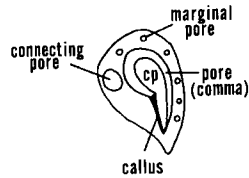
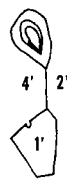
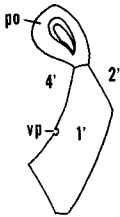
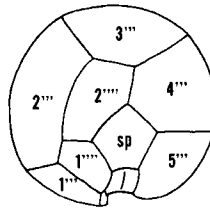
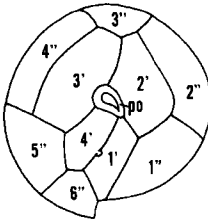
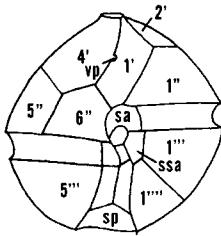

schematic *Alexandrium*

genus, the ventral–dorsal positioning of the APC and the age of the theca can produce an apical protuberance. *Gessnerium*: like *Alexandrium*, in this subgenus, the 1' is displaced from the Po and the 1' is under the 4' rather than adjacent to that plate. Several species of this genus are toxic and/or bioluminescent. Toxic species can produce a number of neurotoxins that can lead to paralytic shellfish poisoning events.

**Remarks:** Species of this genus are differentiated by the following characters: shape and position of the Po plate, shape and position of pores (foramen) in the Po and sp plates, shape of sa, the presence and size of the ventral pore, displacement of 1' plate, shape and size of the ssa, chain formation, shape and size of 6", shape of cell, and cell dimensions.

***Alexandrium acatenella*** (Whedon & Kofoid) Balech 1985 (Plate 36)

Nonchain forming species and cells longer than wide; species is ambiguous with close affinities to *A. tamarense*. The epitheca is longer than the hypotheca, the Po has a callus, sa in combination with the posterior edge of the 1' are unique and help differentiate this species from others in this group. Toxic.

**Remarks:** This species needs to be studied in more detail to resolve conservative characters that may routinely separate it from *A. tamarense*.

**Distribution:** Coastal; North Pacific of the United States and Canada, north of Japan, and Argentina.

***Alexandrium affine*** (Inoue & Fukuyo) Balech 1992 (Plates 3 and 37)

**Synonyms:** *A. fukuyoi* Balech 1985, *nomen nudum*; *Protogonyaulax* sp. Fukuyo 1981.

Chain-forming species. The Po is distinctive in shape and position of attachment pore.

**Remarks:** The closest species is *A. fraterculus*, but the Po differences are diagnostic.

**Distribution:** Coastal; Japan, Korea, Gulf of Thailand, Philippines, and the Iberian peninsula.

***Alexandrium andersonii*** Balech 1990 (Plate 36)

Small species with broadly conical to hemispherical epitheca and hemispherical hypotheca. Narrow 1' with vp, adjacent to a characteristic sa and a characteristic 6". In Balech's description, he specifies that the sa and 6" plates separate this species from known similar species.

**Remarks:** New species with relatively unknown distribution beyond the type locality.

**Distribution:** Coastal; Atlantic Ocean of the United States.

***Alexandrium angustitubulatum*** Taylor in Balech, 1995 (Plate 35)

Small species with the 1' lacking a ventral pore and is otherwise similar to *A. minutum*. The shape of the 1' and the narrow 6" are diagnostic when used in conjunction with APC and sulcal plates.

Alexandrium

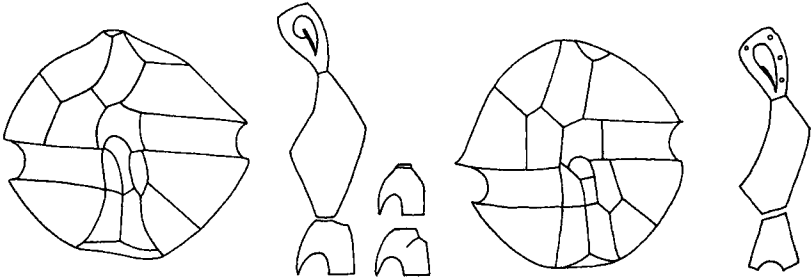

*A. fundyense*

*A. angustitabulatum*

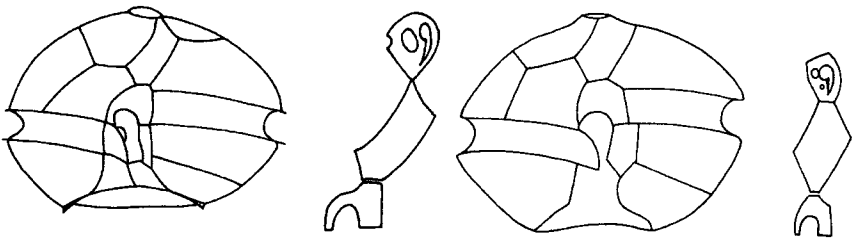

*A. compressum*

*A. catenella*

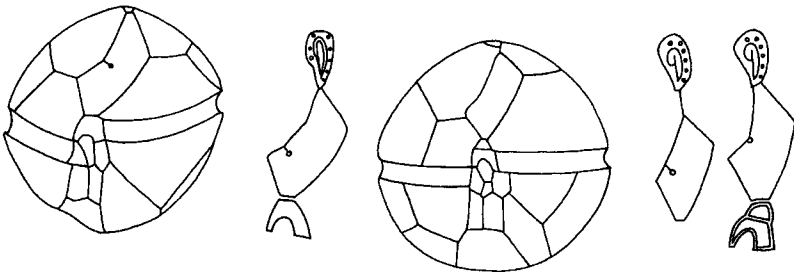

*A. leei*

*A. kutnerae*

PLATE 35 *Alexandrium fundyense*, *A. angustitabulatum*, *A. compressum*, *A. catenella*, *A. leei*, and *A. kutnerae*. Scale = 10  $\mu$ m. Redrawn from Balech (1995).



**Remarks:** New species with unknown distribution beyond its type locality.  
**Distribution:** Coastal; New Zealand.

*Alexandrium balechii* (Steidinger) F. J. R. Taylor 1979 (Plates 3 and 39)

The displaced 1', sa, Po, and 6" are diagnostic when used in conjunction with the size, shape, and surface markings. The epitheca typically has small pores, while the hypotheca has reticulae or vermiculae. The 6" is triangular and directly adjacent to the sa.

**Remarks:** This species is closest to *A. foedum*.

**Distribution:** Coastal; Gulf of Mexico, Gulf of Salerno, Greece.

*Alexandrium catenella* (Whedon & Kofoid) Balech 1985 (Plate 35)

Chain-forming species with anterioposterior compression. Epitheca has shoulders and the cingulum has curtain fins. Hypotheca has prominent sulcal lists that appear as spines. The 1' is without a vp and the APC is diagnostic. Toxic.

**Remarks:** This species can be distinguished from its nearest relatives by cell shape, no vp, Po touching the 1', and the APC.

**Distribution:** Cold water species, coastal, Pacific Ocean of North America, south and central Chile, southern Argentina, western South Africa, Japan, Kamchatka peninsula in the Soviet Union, Tasmania, and south of Australia. Also found in southern California in Monterey Bay in 1991.

*Alexandrium cohorticula* (Balech) Balech 1985 (Plate 37)

Typical cell shape and cell with well-developed sulcal lists. APC, sa, and sp diagnostic. sa with a precingular component.

**Distribution:** Warm water species, coastal; Gulf of Mexico, possibly Gulf of California.

*Alexandrium compressum* (Fukuyo, Yoshida, & Inoue) Balech 1992 (Plate 35)

Chain-forming species similar to *A. catenella*. Species has characteristic large Po and a sp similar to *A. monilatum* with a central pap. Also, hypothecal plates can have thicker irregular crests.

**Remarks:** This species also lacks a vp, is antero-posteriorly compressed, and could be confused with *A. catenella* except the APC is diagnostic. In certain areas, this species can be heavily parasitized by *Amoebophrya*.

This parasite can change the shape and proportions of an *Alexandrium* cell.

**Distribution:** Coastal; Pacific Ocean off Japan and southern California.

*Alexandrium concavum* (Gaarder) Balech 1985 (Plate 36)

Medium- to large-sized pentagonal cell with conical epitheca and concave sides in ventral view.

**Distribution:** Oceanic; warm temperate to tropical.

Alexandrium

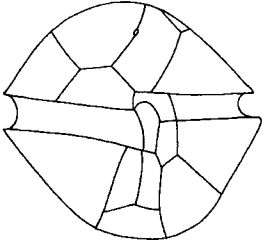

*A. tamarense*

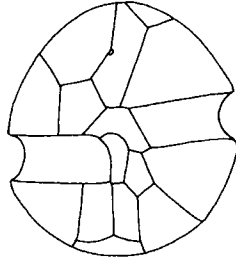

*A. andersonii*

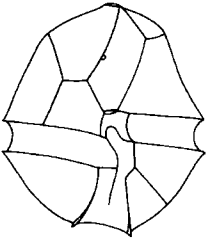

*A. acatenella*

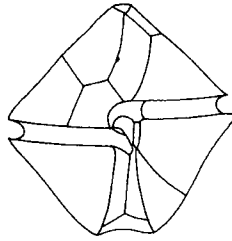

*A. concavum*

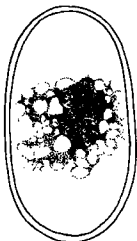

10 μ

*A. tamarense* cyst

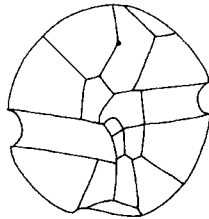

*A. lusitanicum*



PLATE 36 *Alexandrium tamarense*, *A. andersonii*, *A. acatenella*, *A. concavum*, *A. tamarense* cyst, and *A. lusitanicum*. Scale = 10 μm. Redrawn from Balech (1995).

***Alexandrium foedum* Balech 1990 (Plates 3 and 39)**

Similar to *A. balechii* and found in the same Mediterranean locality. Cell more angular with a thicker theca and with distinct pores on both epi- and hypothecae. The sa, 6", ssa, and sp are diagnostically different between these species.

**Remarks:** As with other new species, distribution is now limited to type locality.

**Distribution:** Coastal; Gulf of Salerno, Italy.

***Alexandrium fraterculus* (Balech) Balech 1985 (Plate 37)**

Chain-forming species. Cells elongate, not compressed, and with prominent sulcal lists. 1' plate with vp and APC are diagnostic for species.

**Remarks:** As in all *Alexandrium*, a combination of characters will separate species; however, in many of these species, the APC/1'/sa complex is enough to separate species or even recognize new species.

**Distribution:** Warm water species, mainly littoral; Japan, Korea, Gulf of Thailand, Philippines, South Atlantic.

***Alexandrium fundyense* Balech 1985 (Plate 35)**

This species is almost identical to *A. tamarense* except that it lacks a ventral pore.

**Remarks:** This species is ambiguous both morphologically and biochemically; therefore, whether it should remain as a separate species requires further study. Toxic.

**Distribution:** Littoral; Bay of Fundy and from the Canadian Atlantic to almost 41°N in the United States.

***Alexandrium hiranoi* Kita & Fukuyo 1988 (Plate 39)**

Small to medium-sized globular cell. Epitheca hemispherical; hypotheca asymmetrical. Ventral pore round, occupying edges of 1' and 4'. 1' narrow.

**Remarks:** Can easily be confused with *A. pseudogonyaulax* but differs in ventral pore, cell shape, and shape of 1'.

**Distribution:** Rookpools; Japan.

***Alexandrium insuetum* Balech 1985 (Plate 38)**

Cells small and ovoid; cell surface reticulate. Displaced 1' with vp of a distinct type.

**Remarks:** As more specimens are studied, variations will be confirmed. Although Yuki and Yoshimatsu (1990) reported eight sulcal plates, Balech (1995) reports 9s.

**Distribution:** Coastal; Korea and Japan.

Alexandrium

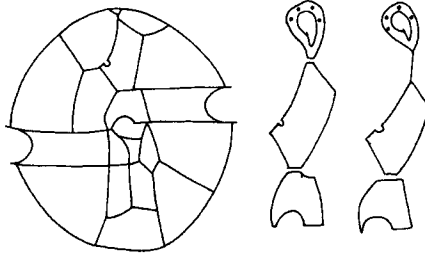

*A. minutum*

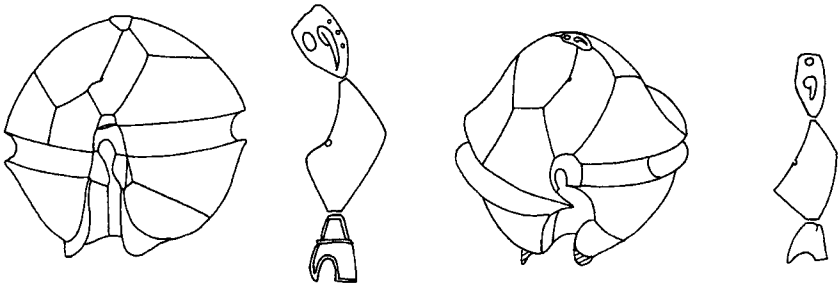

*A. cohorticala*



*A. affine*

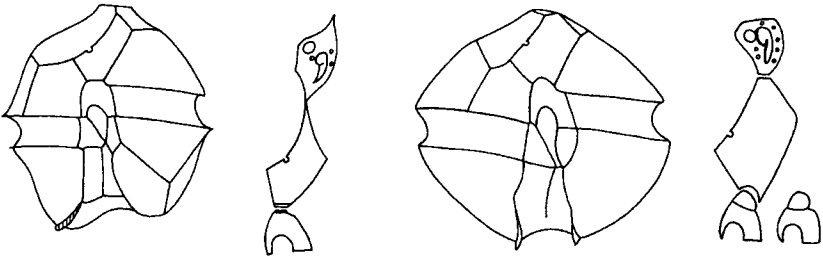

*A. fraterculus*



*A. tamiyavanichi*

PLATE 37 *Alexandrium minutum*, *A. cohorticala*, *A. affine*, *A. fraterculus*, and *A. tamiyavanichi*. Scale = 10  $\mu$ m. Redrawn from Balech (1995).

Alexandrium

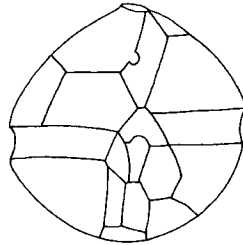
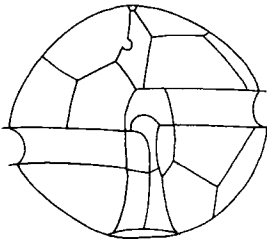

*A. tropicale*

*A. peruvianum*

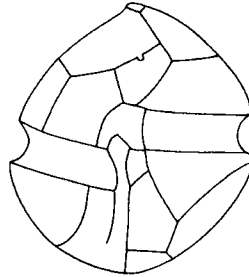
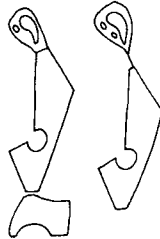
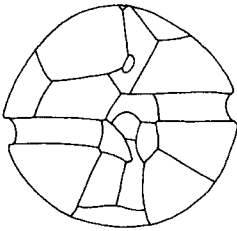

*A. ostenfeldii*

*A. insuetum*

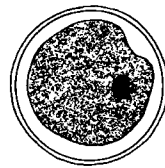
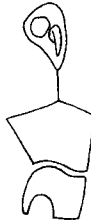
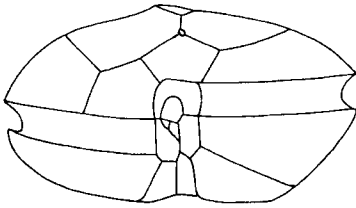

*A. monilatum*

PLATE 38 *Alexandrium tropicale*, *A. peruvianum*, *A. ostenfeldii*, *A. insuetum*, *A. monilatum*, and *A. monilatum* cyst. Scale = 10  $\mu$ m. Redrawn from Balech (1995).

*Alexandrium kutnerae* (Balech) Balech 1985 (Plate 35)

Large spherical cell with an interesting sa that has a precingular component. Ventral pore in 1' can be at the edge of the anterior right

side or it can be a short distance into the 1' connected by a line; it is a variable character.

**Distribution:** Coastal; Atlantic Ocean off South America from approximately 24°S to 38°S.

***Alexandrium leei*** Balech 1985 (Plate 35)

Large, conical cell with a longer left hypothecal lobe. Lacks sulcal lists but does have a ventral pore that is variable in placement. The ssa is different than in other similar species.

**Remarks:** Most similar species is *A. kutnerae*.

**Distribution:** Coastal; Korea, Japan, Gulf of Thailand, and the Philippines.

***Alexandrium lusitanicum*** Balech 1985 (Plate 36)

Similar to type species and other small related species like *A. andersonii* and *A. angustitabulatum*; however, the sa of this species is of a different shape. Toxic.

**Distribution:** Coastal; Iberian peninsula.

***Alexandrium margalefi*** Balech 1992 (Plate 39)

One of the most distinct species described. 1' displaced and only slightly higher than 6". The vp is at the juncture of the 4' and 1' in the left corner. The Po has a well-developed callus. The sp is unique.

**Distribution:** Distribution unknown beyond the type locality of Ria de Vigo, Spain.

***Alexandrium minutum*** Halim 1960 (Plate 37)

**Synonym:** *A. ibericum* Balech 1985.

*Alexandrium* with a typical 1' and ventral pore and connection of the 1' to the Po. This connection may be obscured by growth overlap of 2' and 4' plates or may appear as a thin line connecting the 1' and Po. Characteristic sa and ssa. Epithecal profile goes from hemispherical to conical. Different isolates have different surface markings. Toxic.

**Remarks:** This species can be reticulated, either light or heavy markings.

**Distribution:** Coastal; Alexandria Harbor, Egypt; Bay of Naples, Italy; Bay of Izmir, Turkey; Greece; Spain; Portugal; France; south of England; New York state, United States; and south of Australia.

***Alexandrium monilatum*** (Howell) F. J. R. Taylor 1979 (Plates 3 and 38)

**Synonyms:** *Gonyaulax monilata* Howell 1953; *Gessnerium mochimaensis* Halim 1967; *Gessnerium monilata* (Howell) Loeblich III 1970; *Pyrodinium monilatum* (Howell) F. J. R. Taylor 1976.

Chain former in nature; in culture short chains or single cells. The displaced 1' plate is broadly pentagonal and in culture varies in shape and placement. In clonal culture, the species isolates from Florida coastal

Alexandrium

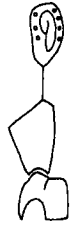
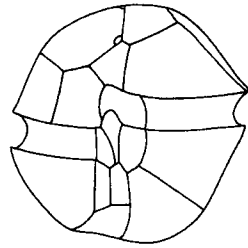
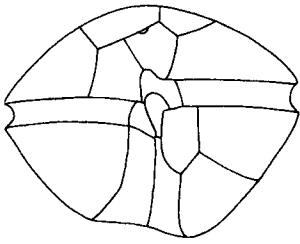

*A. pseudogonyaulax*

*A. taylorii*

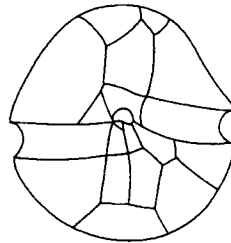
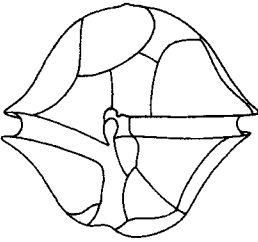

*A. foedum*

*A. balechii*

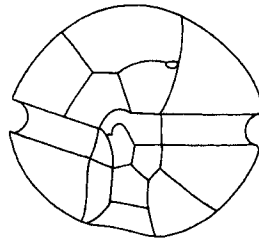
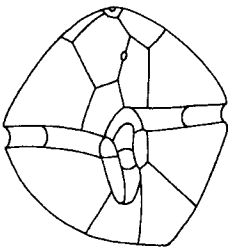

*A. hiranoi*

*A. margelefi*

PLATE 39 *Alexandrium pseudogonyaulax*, *A. taylorii*, *A. foedum*, *A. balechii*, *A. hiranoi*, and *A. margelefi*. Scale = 10  $\mu$ m. Redrawn from Balech (1995).

waters can have a small ventral pore at the apex of the 1' where the 1', 2', and 4' plates meet. The **sp** plate is distinctive in shape, size, and location of the **pap**. The **sp** plate is concave and recessed; it also has radial raised markings. Toxic.

**Remarks:** Distinct from other *Gessnerium* by the APC and **sp**. Distinct from other chain formers by displaced 1' and anterioposterior compression of cells in chains. Plates are thin and difficult to discern; therefore, it is best to use DIC or fluorescent microscopy if available. This species is the type for the subgenus.

**Distribution:** Coastal and estuarine; Gulf of Mexico, Caribbean Sea, Atlantic Ocean off Florida and the Chesapeake Bay, and Ecuador.

*Alexandrium ostenfeldii* (Paulsen) Balech & Tangen 1985 (Plate 38)

**Synonyms:** *Goniodoma ostenfeldii* Paulsen 1904; *Gonyaulax tamarensis* Lebour var. *globosa* Braarud 1945; *Gonyaulax ostenfeldii* (Paulsen) Paulsen 1949; *Heteraulacus ostenfeldii* (Paulsen) Loeblich III 1970; *Gonyaulax globosa* (Braarud) Balech 1971; *Gonyaulax trygvei* Parke 1976; *Protogonyaulax globosa* (Braarud) Taylor 1979; *Gessnerium ostenfeldii* (Paulsen) L. Loeblich and Loeblich III 1979; *Pyrodinium phoneus* Woloszynska and Conrad 1939; *Triadinium ostenfeldii* (Paulsen) Dodge 1981.

Large species with characteristic large ventral pore and thin theca. Toxic.

**Remarks:** Resembles *A. peruvianum*, but is slightly larger with distinctions in the 1', **sa**, and APC.

**Distribution:** Coastal; European Atlantic from Norway to Spain; Iceland; Baring Sea; Kara Sea; Chukchi Sea; Kamchatka peninsula of the Soviet Union; Washington state, United States; and Alexandria Harbor, Egypt.

*Alexandrium peruvianum* (Balech & Mendiola) Balech & Tangen 1985 (Plate 38)

Large cell with prominent ventral pore as in *A. ostenfeldii*. In some cells, the APC is raised and forms an apical protuberance; character is variable. Right margin of the 1' is noticeably curved, while in *A. ostenfeldii*, the right margin is more angular.

**Distribution:** Coastal; Peru and New York state, United States.

*Alexandrium pseudogonyaulax* (Biecheler) Horiguchi ex Kita & Fukuyo 1992 (Plate 39)

This is a medium-sized cell with a characteristically displaced 1', **sa**, and **sp**. The **sp** is unique with an anterior truncated hook. The **sa** has a precingular component that is not demarcated and fits in a notch of the 6" and 1'. Toxic.



**Remarks:** Similar to *A. satoanum* Yuki & Fukuyo 1992.

**Distribution:** Brackish lagoons; southern France, Portugal, Norway, Japan, and Italy.

*Alexandrium tamarensis* (Lebour) Balech 1992 (Plate 36)

**Synonyms:** *Gonyaulax tamarensis* Lebour 1925; *Gonyaulax tamarensis* var. *excavata* Braarud 1945; *Gonyaulax excavata* (Braarud) Balech 1971; *Gessnerium tamarensis* (Lebour) Loeblich III and L. Loeblich 1979; *Protogonyaulax tamarensis* (Lebour) F. J. R. Taylor 1979; and *A. excavatum* (Braarud) Balech and Tangen 1985.

Small to medium cells with size and shape variability. Most typically, epitheca is broadly conical with slight shoulders. The hypotheca is somewhat trapezoidal and posteriorly concave. Often the left side is longer than the right and the hypothecal profile is skewed. The Po has a strongly developed callus and the 1' has a small ventral pore. The sp is short and not attenuated. Toxic and nontoxic strains.

**Remarks:** This species may still have homonyms that sort out morphologically, biochemically, or geographically with new studies.

**Distribution:** Coastal; western Europe from Norway to the Iberian peninsula including the British Isles, the Atlantic Ocean of the United States from Maine to 40°N, Argentina, Japan, Korea, Gulf of Thailand, Canadian Pacific, Venezuela, Barents Sea, Kamchatka peninsula in the Soviet Union, and south of Taiwan.

*Alexandrium tamiyavanichi* Balech 1994 (Plate 37)

This species has curtain fins, and distinctive APC, 1', and sa. Toxic.

**Remarks:** New species of unknown distribution beyond its type locality.

**Distribution:** Coastal; Gulf of Thailand and the Philippines.

*Alexandrium taylorii* Balech 1994 (Plate 39)

Subspherical cell with angled hypothecal profile. Cingulum with curtain fins. Characteristic 1' with anterior vp at juncture of 1', 2' and 4'.

Unusual sacp and characteristic sp.

**Remarks:** New species with unknown distribution beyond its type locality.

**Distribution:** Bay of Arcachon, France.

*Alexandrium tropicale* Balech 1985 (Plate 38)

**Synonyms:** *Gonyaulax excavata* (Braarud) Balech 1971; *G. tamarensis* var. *excavata* Braarud (not *G. excavata* (Braarud) Balech 1971).

Small cell with unique type of 1', otherwise character combinations have to be used to distinguish this rounded cell from a species such as *A. tamarensis*.

**Remarks:** Found in waters >27°C.

**Distribution:** Oceanic, warm water species; west equatorial Atlantic.

**Genus *Gambierdiscus*** Adachi & Fukuyo 1979 (1 sp.)

**Type:** *G. toxicus* Adachi & Fukuyo 1979.

**References:** Adachi & Fukuyo, 1979; F. J. R. Taylor, 1979; Besada et al., 1982; Steidinger, 1983, 1993; Sournia, 1986; Fukuyo et al., 1990; Fensome et al., 1993.

Medium to large species in monophyletic genus in which the cells are anterioposteriorly compressed and the profile is sublenticular. Plate formula: Po, 4', 6", 6c, 8s, 6'", 2'''. Similar to *Goniodoma* but with unique APC. The displaced 1' and the 6" are small, adjacent, and right above the sulcal plates. The cingulum is displaced; however, the distal side recurves and confuses displacement. Chloroplasts present.

***Gambierdiscus toxicus*** Adachi & Fukuyo 1979 (Plate 40)

Species with wide cingular lists and thick thecae with areolae. Toxic.

**Distribution:** Benthic and epiphytic; can be tychoplanktonic. Found on coral reefs to shallow lagoons and bays of tropical and subtropical areas of the oceans. Can be abundant even when attached to macroalgae; attaches by mucoid strands from sulcal area.

**Genus *Goniodoma*** Stein 1883 (>5 spp.)

**Synonyms:** *Heteraulacus* Diesing 1850 in part; *Triadinium* Dodge 1981 in part.

**Type:** *G. acuminatum* (Ehrenberg) Stein 1883.

**References:** Schiller, 1937; Balech, 1980, 1988a; Dodge, 1981a, 1982; F. J. R. Taylor, 1976; Steidinger, 1990, 1993.

Armored. Cells similar to *Alexandrium*, but different in size, thickness of theca, surface markings, size and shape of plates, position of plates, and the presence of strong cingular lists. Plate formula: Po, cp, 4', 6", 6c, 6s, 6'", and 2'''. The 1' is a characteristic shape and is displaced. The connection between the Po and 1' in *Alexandrium* is either direct or in a straight line. In *Goniodoma*, the connection is not straight and appears as two lines at almost right angles. Also, in *Goniodoma* the Po is facing horizontally to the left side of the cell. Large vp in 1' toward the anterior right margin. Chloroplasts present. About half of the current *Alexandrium* species were transferred from *Gonyaulax* and *Goniodoma*.

***Goniodoma polyedricum*** (Pouchet) Jørgensen 1899 (Plates 3 and 40)

Species with very characteristic polyhedral shape, deep set areolae, and cingular lists. Cingulum descending less than two widths. Thecal sutures with crests.

**Distribution:** Oceanic; cosmopolitan in subtropical to tropical waters; worldwide distribution.

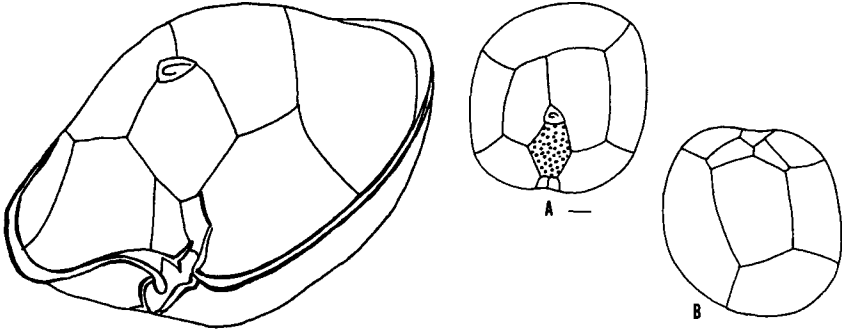

*Gambierdiscus toxicus*

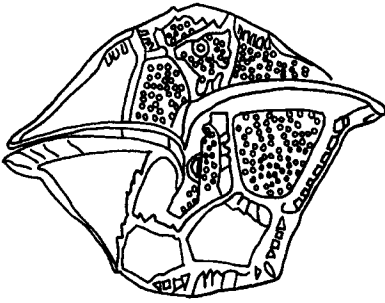

*Goniiodoma polyedricum*

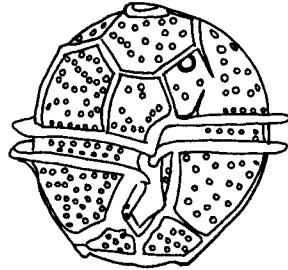

*Goniiodoma sphaericum*

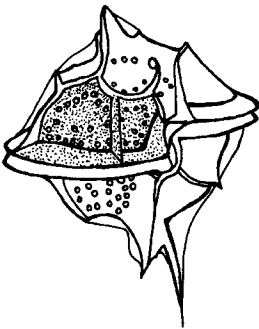

*Pyrodinium bahamense*

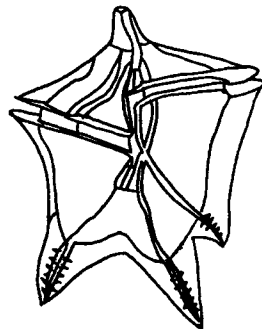

*Acanthogonyaulax spinifera*

PLATE 40 *Gambierdiscus toxicus* (A and B redrawn from Fukuyo, 1981b); *Goniiodoma polyedricum*, *Goniiodoma sphaericum*, *Pyrodinium bahamense* var. *bahamense*, and *Acanthogonyaulax spinifera* redrawn from Graham (1942). Scale = 10  $\mu\text{m}$ .

***Goniodoma sphaericum* Murray & Whitting 1899 (Plate 40)**

Cell rugose and spherical with prominent pores.

**Remarks:** The division line for this species is probably similar to *Alexandrium*.

**Distribution:** Worldwide distribution.

**Genus *Pyrodinium* Plate 1906 (1 sp.)**

**Type:** *P. bahamense* Plate 1906.

**References:** Schiller, 1937; Tafall, 1942; Buchanan, 1968; Wall & Dale, 1969; Steidinger & Williams, 1970; Steidinger et al., 1980; Sournia, 1986; Balech, 1985b; Fensome et al. 1993.

Armored. Monotypic genus with two varieties. Cells medium sized with distinct apical and antapical spines and lists even when cells are in chains. One variety can form long chains in nature. Plate formula: Po, cp, 4-5', 6", 6c, 6s, 6' ", and 2'''. Plate sutures with crests. Chloroplasts present.

***Pyrodinium bahamense* Plate 1906 var. *bahamense* (Plate 40)**

Variety with prominent apical protuberance or horn and an apical spine with a list. Thecal surface markings differ between the two varieties.

**Remarks:** This variety is nontoxic but is bioluminescent. It has a distinct cyst type with an archeopyle. The variety is responsible for massive bioluminescence in certain tropical and subtropical inshore waters. Forms cysts.

**Distribution:** Subtropical to tropical waters; Atlantic.

***Pyrodinium bahamense* var. *compressum* (Böhm) Steidinger, Tester, & Taylor 1980 (not illustrated)**

Variety similar to *P. bahamense* var. *bahamense* but cells typically in chains and slightly anterioposteriorly compressed with associated reductions. Pores larger than in other variety. Toxic. Forms cysts.

**Remarks:** This variety, so far, has only been identified from the Pacific and Indian Oceans, not the Atlantic. Balech (1985b) does not separate out this toxic variety and believes that the species is highly variable.

**Distribution:** Warm water species; Pacific.

**Family Gonyaulacaceae Lindemann 1928****Genus *Acanthogonyaulax* (Kofoid) Graham 1942 (1 sp.)**

**Synonyms:** *Ceratocorys* Stein 1883 in part; *Gonyaulax* Diesing 1866 in part.

**Type:** *A. spinifera* (Murray & Whitting) Graham 1942.

**References:** Graham, 1942; Sournia, 1986.

Armored. Medium- to large-sized cell with prominent hypothecal spines and lists. Cingulum premedian and descending  $3\times$ . Plate formula: Po, 3', 7(6)"?, 6c, 9 (10)s, 6'", and 2'''. Interpretation of small precingulars and anterior sulcal plates is confused. 1' with a ventral pore.

**Remarks:** Species is characteristic but could be confused with *Ceratocorys*.

*Acanthogonyaulax spinifera* (Murray & Whitting) Graham 1942 (Plate 40)

**Distribution:** Oceanic; tropical.

**Genus** *Amphidoma* Stein 1883 (<10 spp.)

**Synonyms:** *Pavillardinium* De-Toni 1936 in part; *Murrayella* Kofoid 1907.

**Type:** *A. nucula* Stein 1883.

**References:** Kofoid, 1907b; Dodge, 1982; Dodge & Saunders, 1985b; Sournia, 1986.

Armored. Cells biconical or attenuated in shape; Po, X(?), 6', 6", 6c, 4s(?), 6'", and 2'''. No anterior intercalaries. Small to medium-sized cells; typically with a descending cingulum ( $<1\times$ ) and an antapical process. Chloroplasts present. APC distinctive. Most species in this genus are not well documented except for the type.

*Amphidoma nucula* Stein 1883 (not illustrated)

Theca heavily marked with reticulae. 1'" small.

**Distribution:** Subtropical to tropical waters; Atlantic Ocean.

**Genus** *Amylax* Meunier 1910 (<5 spp.)

**Synonym:** *Gonyaulax* Diesing 1866 in part.

**Type:** *A. lata* Meunier 1910.

**References:** Kofoid, 1911; Balech, 1977b; Dodge, 1982, 1989; Sournia, 1986; Fensome et al., 1993.

Armored. Small to medium cells with a tapered apical horn and at least one antapical spine. Cell compressed dorsoventrally. Plate formula: Po, 3', 3a, 6", 6c, 7 or 8s, 6'", and 2'''. Narrow 1' with ventral pore in posterior right side. APC with round Po, not oval as in *Gonyaulax*. Chloroplasts present.

*Amylax triacantha* (Jørgensen) Sournia 1984 (Plate 41)

**Synonym:** *Gonyaulax triacantha* Jørgensen 1899.

Cell small, subpyriform with a rather straight antapical profile.

**Remarks:** Close to *A. buxus* (Balech) Dodge 1989, but epithecal and hypothecal profiles differ. In *A. buxus*, there are more rounded profiles.

Division products as in *Gonyaulax* with the anterior daughter cell retaining 1–3', 1 or 2a, 1 or 2", 1–3c, 1–3'", and the sa.

**Distribution:** Coastal; cold water species; Pacific and Atlantic Oceans.

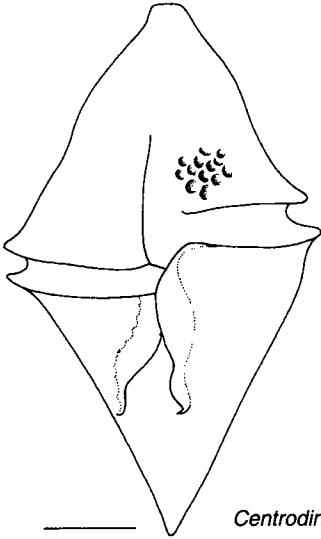

*Centrodinium* sp.

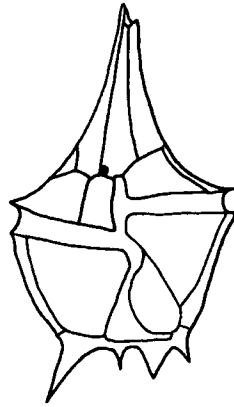

*Amylax triacantha*

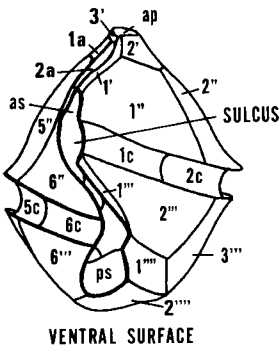

VENTRAL SURFACE

ANTERIOR  
↑  
↓  
POSTERIOR

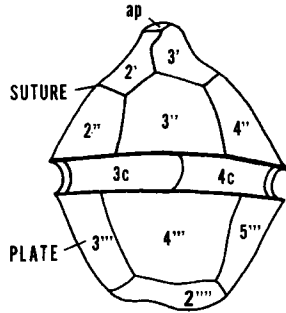

DORSAL SURFACE

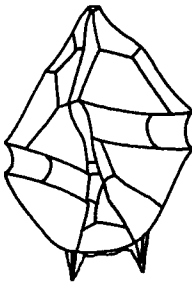

schematic *Gonyaulax*

PLATE 41 *Centrodinium* sp.; *Amylax triacantha* (after Dodge, 1989); schematic of *Gonyaulax* showing ventral and dorsal surfaces (modified from Eaton 1980); schematic of *Gonyaulax* with sulcal plates (redrawn from Balech, 1980). Scale = 10 μm.

**Genus *Gonyaulax*** Diesing 1866 (>100 spp.)

**Synonyms:** *Steiniella* Schütt 1895 in part; *Amylax* Meunier 1910 in part.

**Type:** *G. spinifera* (Claparède & Lachmann) Diesing 1866.

**References:** Kofoid, 1911; Schiller, 1937; Graham, 1942; Steidinger, 1968, 1971; Steidinger & Williams, 1970; F. J. R. Taylor, 1976; Balech, 1977b, 1988a; Dodge, 1982, 1989; Sournia, 1986; Fensome et al., 1993.

Armored, cells subspherical to biconical to fusiform with a descending cingulum up to six cingulum widths, with or without cingulum overhang.

1' can be sigmoid and narrow to rhomboidal as in *Protoperidinium*.

Theca varies in thickness and surface markings. Plate formula: Po, 3', 2a, 6", 6c, 7s, 6'", and 2'''. APC with oval pore plate or elongate oval pore plate, often with linear markings. Chloroplasts present. Documented benthic cysts.

**Remarks:** Even with the confusion over *Gonyaulax*, *Goniodoma*, *Protoceratium*, *Lingulodinium*, *Alexandrium*, *Amylax*, and related genera, the APC of these genera and even the APC within a genus can be used to further separate related species or groups. The genus *Gonyaulax* may still be too broad in application. For example, Dodge (1989) put *G. polyedra* with 3a into the fossil genus *Lingulodinium*. Asexual division products for *G. spinifera* (the type species), *G. grindleyi*, and *G. digitale* are as follows. Anterior daughter cell retains 1–3', 1 or 2a, 1 or 2", 1–3c, 1–3'", sa; the posterior daughter cell retains 3–6', 4–6c, 4 or 5'", 1 or 2''', and the rest of the sulcal plates (Evitt, 1985). Currently, species of this genus are differentiated based on the following characters: size and shape, plate tabulation and pattern, APC (more than one type), cingulum displacement and overhang, development of apical process/horn, and ornamentation.

***Gonyaulax alaskensis*** Kofoid 1911 (not illustrated)

Cells broad and deep with a short apical horn or modified apical process.

Narrow cingulum with  $\geq 3\times$  displacement.

**Distribution:** Oceanic to coastal. Cold water species.

***Gonyaulax fragilis*** (Schütt) Kofoid 1911

Small oval-shaped cell. Cingulum median and displaced  $1\times$ ; cingulum ends can overlap. APC extends onto dorsal surface. Thin theca striated; more striae on hypotheca.

**Remarks:** Can be confused with *G. hyalina* which is more robust in shape but very delicate and has a greater cingulum displacement.

**Distribution:** Oceanic and coastal. Warm temperate and tropical waters.

***Gonyaulax grindleyi*** Reinecke 1967 (Plates 4 and 42)

**Synonym:** *Protoceratium reticulatum* (Claparède & Lachmann) Bütschli 1885.

Species with 1a and ventral pore in right margin of 1'. Polyhedral-shaped cell with prominent reticulations that obscure plates unless disassociated.

Forms cysts.

**Remarks:** The question of whether this is a *Protoceratium* or a *Gonyaulax* may await interpretation of the “lost” small 3' and whether the existing 3' is the 2a plate. However, the APC is similar to that of an *Alexandrium* and not a *Protoceratium*, even though both Po plates have cp components.

Asexual division products as in *Gonyaulax*.

**Distribution:** Neritic, estuarine; cold temperate to subtropical waters.

***Gonyaulax polygramma* Stein 1883 (Plate 42)**

Elongate cell with tapered epitheca; epitheca angular with short to moderate apical horn. Hypotheca symmetrically rounded or truncate. 1' with vp 1' narrow and recessed. Po elliptical and when initially dissected remains attached to the 1'; Po does not extend onto dorsal side. Mature cells with thecal reticulae and striae. Cells typically have two antapical spines. Cingulum descending about 1.5× without an overhang.

**Remarks:** The characteristic striae and shape distinguish this species from all other *Gonyaulax* in the polygramma group. In newly developing cells, thecal maturation progresses from formation of sulcal and cingular grooves to plates and sutures, to thecal pores, to linear striae and antapical spines, to poroids, and finally to reticulae.

**Distribution:** Neritic, oceanic; cosmopolitan in cold temperate to tropical waters; worldwide distribution.

***Gonyaulax scrippsae* Kofoid 1911 (Plate 42)**

Small cell with short to moderate apical horn. Cell and hypotheca rounded; without antapical spines. Descending cingulum with slight overhang. Raised thecal markings present. Forms cysts.

**Distribution:** Neritic, oceanic (rare); worldwide distribution.

***Gonyaulax spinifera* (Claparède & Lachmann) Diesing 1866 (Plate 42)**

**Synonym:** *Peridinium spiniferum* Claparède & Lachmann 1859.

Small *Gonyaulax* with prominent, excavated cingulum that is descending by at least two cingulum widths and has an overhang. The angled, conical epitheca has a short to moderate apical horn. Ventral pore between 2a and 3', not in right margin of 1'. Two antapical spines typically present, but not diagnostic. Forms cysts.

**Remarks:** Often, *G. spinifera*, *G. digitale*, and *G. diegensis* are confused. These three species can be distinguished by stoutness of apical horn, width of cingulum and amount of displacement, and general shape. *Gonyaulax diegensis* is round with a widely displaced narrower cingulum. *Gonyaulax digitale* typically has epithecal shoulders and a moderate apical horn.



Gonyaulax

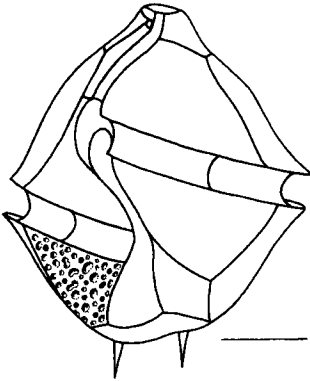

*G. spinifera*

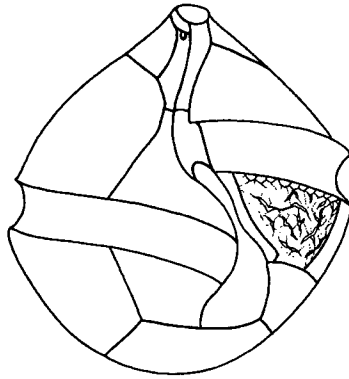

*G. scrippsae*

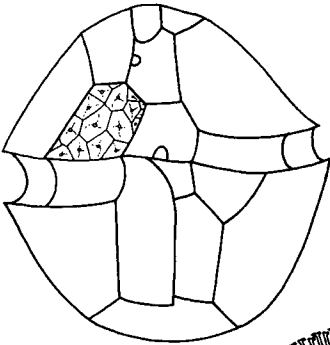

*G. grindleyi*

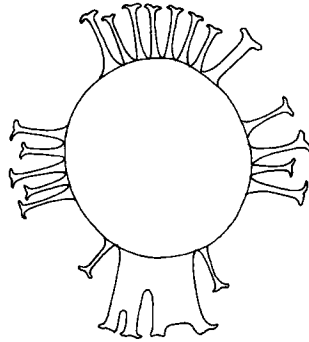

*G. scrippsae* cyst

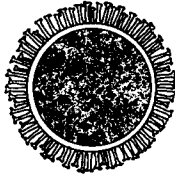

*G. grindleyi* cyst

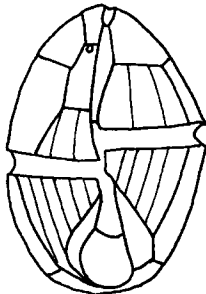

*G. fragilis*

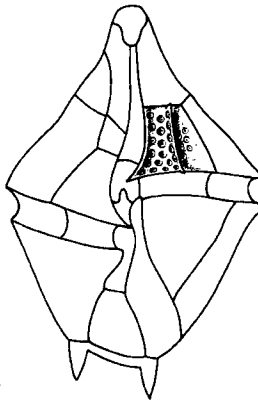

*G. polygramma*

*Gonyaulax spinifera* produces polymorphic cysts. In all likelihood, the taxon *G. spinifera* represents several species or sibling species.

**Distribution:** Neritic, estuarine, oceanic; cosmopolitan; Pacific Ocean, Mediterranean Sea, Atlantic Ocean, and the Gulf of Mexico.

*Gonyaulax verior* Sournia 1973 (not illustrated)

**Synonyms:** *Amylax diacantha* Meunier 1919; *Gonyaulax diacantha sensu* Schiller 1937.

Gradually tapered epitheca with a short apical horn that is flanged, apical pore complex area with a tear-shaped Po. The 1' has a ventral pore at the juncture of the 2a and 3'. Cell dorsoventrally compressed with two prominent antapical spines. At low magnification appears as thin, delicate cell.

**Remarks:** This species is truly synonymous with *G. diacantha* and is rarely confused with any other species.

**Distribution:** Brackish water species. Temperate to tropical waters; cosmopolitan.

### Genus *Lingulodinium*

**Synonym:** *Gonyaulax polyedra* Stein 1883.

**Cyst synonym:** *L. machaerophorum* (Deflandre & Cookson) Wall 1967.

**Type:** *Lingulodinium polyedrum* (Stein) Dodge 1989

**References:** Kofoid, 1911; Dodge, 1989; Fensome et al. 1993.

Cell polyedral shaped, without antapical spines and apical horn.

Descending cingulum without overhang. Theca is reticulate to areolate with pores in the depressions. Plate formula: Po, 3', 3a, 6", 6c, 7s, 6' ", and 2" ". The APC is characteristic of *Gonyaulax*, e.g., *G. verior* and *G. digitale*. The raised inner elliptical rim of the Po can be closely appressed and appears as a lattice or protuberances.

**Remarks:** If plate reduction is the evolutionary path of armored dinoflagellates, then this species may be an ancestral form with 3a that was later reduced to 2a in more recent species. Clearly, the 1a of the typical *Gonyaulax* cell is large enough to split in two making three anterior intercalaries of approximately the same size. It is not uncommon to find cells in artificial culture where one plate has split into two. Perhaps a species retains the genetic code for the old pattern and reversion is possible.

***Lingulodinium polyedrum*** (Stein) Dodge 1989 (Plate 43)

**Description:** Same as that for genus. Forms distinctive cysts. Toxic.

**Distribution:** Neritic; warm temperate to tropical waters.

**Genus *Peridiniella*** Kofoid & Michener 1911 emend. Balech 1977 (<5 spp.)

**Synonyms:** *Gonyaulax* Diesing 1866 in part; *Amylax* Meunier 1910 in part.

**Type:** *P. sphaeroidea* Kofoid & Michener 1911.

**References:** Balech, 1977b, 1980; Dodge, 1987.

Armored. Epitheca with a *Protoperidinium* plate tabulation and pattern, hypotheca with a *Gonyaulax* plate tabulation; Po, x, 4', 3 or 4a, 7", 6c, 6 or 7s, 6' ", 2''' . Descending cingulum, displaced about one width. Theca with surface markings, e.g., reticulations. sa similar to *Alexandrium* type. Chloroplasts present.

***Peridiniella catenata*** (Levander) Balech 1977 (Plate 43)

**Synonyms:** *Gonyaulax catenata* (Levander) Kofoid 1911; *Amylax catenata* (Levander) Meunier 1910.

**Reference:** Kofoid, 1911b.

Single or catenate cells; shape varies with habit. Small species with 4a.

**Remarks:** The 2a and 3a plates are small as if one plate split into two or they are ancestral plates in the lineage of *Peridiniella*. For example, in the type species there are 3a plates, the 2a plate could be a reduction and reorientation of two smaller plates.

**Distribution:** Brackish cold water species that can form blooms.

**Genus *Protoceratium*** Bergh 1881 (>10 spp.)

**Synonym:** *Gonyaulax* Diesing 1866 in part.

**Type:** *P. aceros* Bergh 1881.

**References:** Reinecke, 1967; Wall & Dale, 1968; von Stosch, 1969a; Steidinger & Williams, 1970; F. J. R. Taylor, 1976; Dodge, 1982.

Small, oval to broadly biconical cell. Heavy reticulations or areolations obscure the plate pattern which can only be determined upon treatment or dissection. Plate formula: Po, 3', 0a, 6", 6c, 6s, 6''' , and 2''' , following Balech (1988a). Cingulum descending <1 cingulum width. The 1' lacks a vp and the Po is round with a crescent-shaped pore. The APC differentiates this group from *Gonyaulax* and *Alexandrium*, although *Protoceratium* species have an sa that approaches an *Alexandrium*. Chloroplasts present.

***Protoceratium spinulosum*** (Murray & Whitting) Schiller 1937 (Plate 43)

Crested reticulæ appear as spines at crest junctures. APC with round to oval Po with crescent-shaped pore. Closing plate possible, but not observed. Pore not comma shape of *Alexandrium*.

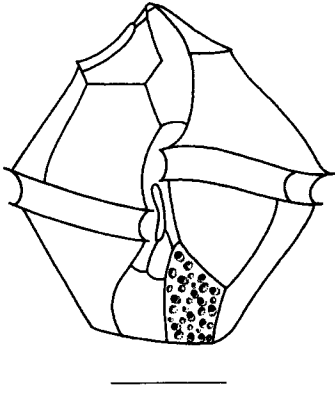

*Lingulodinium polyedrum*

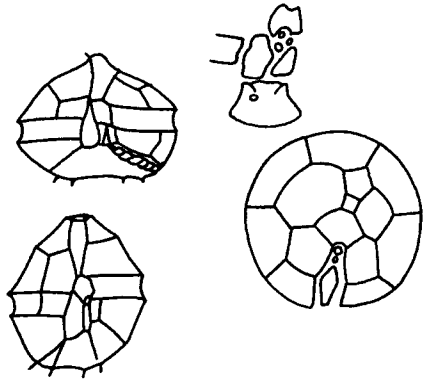

*Peridinella catenata*

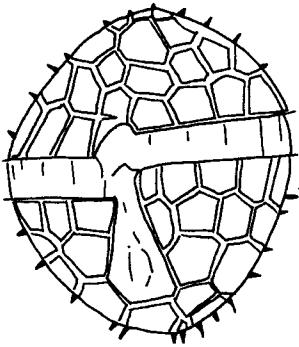

*Protoceratium spinulosum*

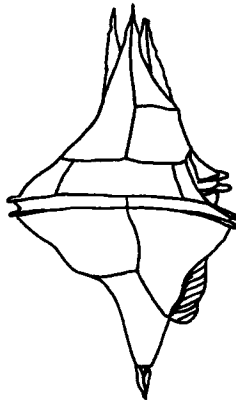

*Spiraulax kofoidii*



*Schuetiella mitra*

PLATE 43 Scale = 10  $\mu$ m unless otherwise indicated. *Lingulodinium polyedrum*; *Peridinella catenata* (redrawn from Balech, 1980), *Protoceratium spinulosum*, *Spiraulax kofoidii* (redrawn from Graham, 1942) (scale = 50  $\mu$ m), *Schuetiella mitra* (scale = 50  $\mu$ m) redrawn from Graham (1942).

**Remarks:** The APC of all *Protoceratium* should be documented and described to evaluate relatedness within the Gonyaulacales.

**Distribution:** Atlantic Ocean.

**Genus *Schuettiella* Balech 1988**

**Synonyms:** *Gonyaulax* Diesing 1866 in part; *Oxytoxum* Stein 1883 in part; *Steinella* Schütt 1895 in part.

**Type:** *S. mitra* (Schütt) Balech 1988.

**References:** Kofoid, 1907, 1911a; Balech, 1988a; Fensome et al., 1993.

Armored. Large, delicate cell with descending cingulum  $>3\times$ . Cell with distinct, delicate longitudinal lines with regularly placed pores. Distinctly different APC. In type species, cell fusiform and cingulum descending up to  $6\times$ . Plate formula Po, cp?, 2', 1a, 6", 6c, 9s, 6"', and 2'''. Chloroplasts present.

***Schuettiella mitra* (Schütt) Balech 1988 (Plate 43)**

**Synonyms:** *Steinella mitra* Schütt 1895; *Gonyaulax mitra* (Schütt) Kofoid 1911; *Oxytoxum gigas* Kofoid 1907.

Species with unique longitudinal striae that regularly encircle pores and appear as a hook-and-eye pattern as also found in *Oxytoxum*. APC distinct and different from *Gonyaulax*.

**Remarks:** Found in waters  $>18^\circ\text{C}$ .

**Distribution:** Tropical waters; Mediterranean Sea, Atlantic and Pacific Oceans.

**Genus *Spiraulax* Kofoid 1911**

**Synonym:** *Gonyaulax* Diesing 1866 in part.

**Type:** *Spiraulax kofoidii* Graham 1942 [= *S. jolliffei* (Murray & Whitting) Kofoid 1911].

**References:** Kofoid, 1911c; Sournia, 1986.

Armored. Monospecific genus. Large, broadly fusiform cell with 2'''' posteriorly attenuated to a prominent antapical spine. Cingulum narrow and median, descending up to  $5\times$ . Both left and right sulcal lists well developed. Theca well developed and areolate. Plate formula: Po, 3', 2a, 6", 6c, 7s, 6''', and 2'''. Po not yet described. Chloroplasts present.

**Remarks:** Although *Spiraulax* is close to *Gonyaulax*, it differs in plate pattern. The 2a and 1'' are situated above the sa plate and the 1' is not the narrow long characteristic plate it is in *Gonyaulax*.

***Spiraulax kofoidii* Graham 1942 (Plate 43)**

**Description:** Same as that for genus.

**Distribution:** Oceanic, widely distributed in tropical and subtropical waters.

**Family Heterodiniaceae Lindemann 1928****Genus *Heterodinium*** Kofoid 1906 (>50 spp.)**Synonym:** *Peridinium* sec. Murray & Whitting 1899 in part.**Type:** *H. scrippsae* Kofoid 1906.**References:** Kofoid, 1906a; Kofoid & Adamson, 1933; F. J. R. Taylor, 1976; Rampi & Bernhard, 1980; Sournia, 1986; Balech, 1988a.

Armored. Small to large cells, some species compressed dorsoventrally; epitheca conical, hypotheca conical with spines or two prominent horns. Individual reticulæ with usually one, maybe two, poroids, poroids with multiple pores, or reticulæ with multiple pores. Metacytic areas can be very wide and relatively free of markings. Plate formula: Po, cp, 3', 2a, 6'', 6c, 6''', and 3'''. 1a is ventral with a pore and the 2a is dorsal. Cingulum descending with or without overhang; however, posterior cingular list absent or greatly reduced as that in *Palaeophalacroma*. Chloroplasts present or absent.

***Heterodinium milneri*** (Murray & Whitting) Kofoid 1906 (not illustrated)

Cell with descending cingulum, about 2.5× displacement, premedian with prominent overhang; epitheca shorter than hypotheca and conical with an apical process. Hypotheca with winged spines. Cell not dorsoventrally flattened as in some other *Heterodinium*.

**Remarks:** Due to ventral overlap of apical plates, clarification of the apical series and the anterior intercalaries needs to be made, at least in this species, e.g., in what plate is the vp located?

**Distribution:** Oceanic; cold temperate to tropical waters.***Heterodinium rigdenae*** Kofoid 1906 (Plate 44)

Cell dorsoventrally flattened with two antapical horns. Epitheca with lateral crests. Cingulum equatorial and descending, <1.5×, no overhang. *Proto-peridinium* outline.

**Distribution:** Warm temperate to tropical waters; Pacific Ocean, Indian Ocean, and Mediterranean Sea.**Family Ostreopsidaceae Lindemann 1928****Genus *Coolia*** Meunier 1919 (1 sp.)**Synonyms:** *Ostreopsis* Schmidt 1901 in part; *Glenodinium* Ehrenberg 1837 in part.**Type:** *C. monotis* Meunier 1919.**References:** Schiller, 1937; Biecheler, 1952; Balech, 1956; Fukuyo, 1981b; Besada et al., 1982; Dodge, 1982; Norris et al., 1985; Faust, 1992; Fensome et al., 1993; Steidinger, 1993.

Armored. Cell small, slightly compressed anterioposteriorly and oval in ventral view. Axes off center, nearly oblique; cingulum descending and in

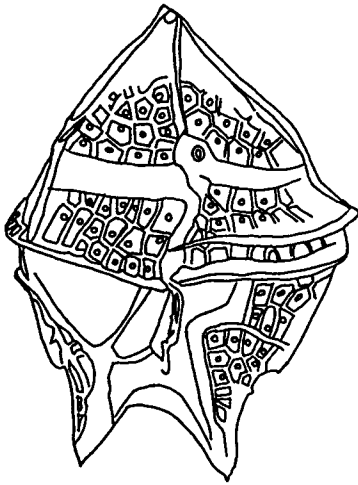

*Heterodinium rigdenae*

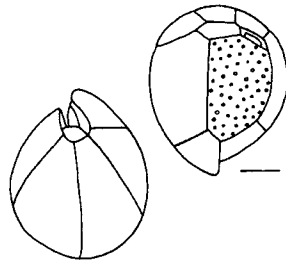

*Coolia monotis*

Ostreopsis

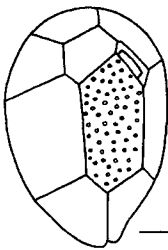

*O. siamensis*

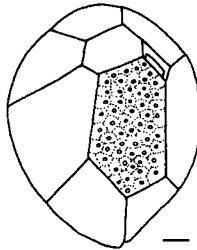

*O. lenticularis*

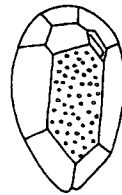

*O. ovata*

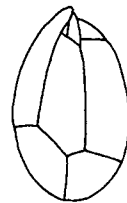
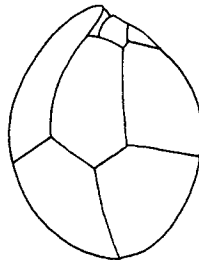
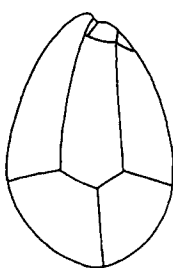

PLATE 44 *Heterodinium rigdenae*, *Coolia monotis*, *Ostreopsis lenticularis*, *Ostreopsis ovata*, and *Ostreopsis siamensis* redrawn from Fukuyo (1981b). Scale = 10  $\mu$ m.

lateral view appears straight. Plate formula: Po, 3'(4'), 7''(6''), 6c,  $\geq 6s$ , 5''', 1p, and 2'''. Vp between 1'' and 7''. Apex displaced dorsally and to the left. In apical view, epitheca smaller than hypotheca. Chloroplasts present.

***Coolia monotis* Meunier 1919 (Plates 5 and 44)**

**Remarks:** The number and configuration of sulcal plates between *Ostreopsis* and *Coolia* needs study as does the 1'' plate because this plate may be homologous to a 1' as Besada et al. (1982) have suggested for *O. ovata* based on plate overlap patterns and the presence of a vp at the right margin of the plate. The hypothecal plate pattern is entirely different than that in *Ostreopsis* and the cell shape is different. Two distinct size classes occur in culture. Toxic.

**Distribution:** Planktonic, benthic, and epiphytic; brackish water species; temperate to tropical waters; worldwide distribution.

**Genus *Ostreopsis* Schmidt 1901 (<5 spp.)**

**Type:** *O. siamensis* Schmidt 1901.

Armored. Medium to large-sized cells, anterioposteriorly compressed, tear shaped in apical view and tapering ventrally. Cingulum not descending and epitheca not noticeably smaller than hypotheca in apical view. Same plate formula as in *Coolia* and with a vp between 1'' and 7'' or 1' and 6'', depending on interpretation of plates. Cingular area in lateral view undulating or straight. Apex displaced to the dorsal surface, left side. Characteristic Po with slit. Chloroplasts present.

***Ostreopsis heptagona* Norris, Bomber, & Balech, 1985 (Plate 5)**

Medium-sized species with characteristic 1' that is seven sided, not six sided as in other species.

**Distribution:** Known from Florida coastal waters.

***Ostreopsis lenticularis* Fukuyo 1981 (Plate 44)**

Medium-sized lenticular cell without undulating cingulum in lateral view; broadly ovate.

**Remarks:** Similar to type species, but lacks undulation of cingulum in lateral view and the theca has numerous fine pores. Po plate of *Ostreopsis* species longer than that of *Coolia*. Toxic.

**Distribution:** Tycoplanktonic, benthic, or epiphytic; tropical shallow waters to offshore reefs.

***Ostreopsis ovata* Fukuyo 1981 (Plate 44)**

Small to medium-sized ovate cell in dorsoventral view but narrow. Theca with scattered pores. Eight sulcal plates.

**Remarks:** Documentation in this species presents a good argument for the 1'' being a displaced 1' with a ventral pore.



**Distribution:** Tytoplanktonic, benthic, or epiphytic; tropical shallow waters to offshore reefs.

***Ostreopsis siamensis*** Schmidt 1901 (Plate 44)

Medium-sized ovoid cell. Cingulum undulates in lateral view. Theca with scattered pores. Toxic.

**Distribution:** Benthic, epiphytic; can be tytoplanktonic. Warm waters.

**Family Oxytoxaceae** Lindemann 1928

**References:** Kofoid, 1907; Schiller, 1937; Gaarder, 1954; Steidinger & Williams, 1970; F. J. R. Taylor, 1976; Dodge & Saunders, 1985a; Balech, 1988; Sournia, 1986; Fensome et al., 1993.

**Genus *Centrodinium*** Kofoid 1907 (<10 spp.)

**Synonyms:** *Pavillardinium* De-Toni 1936 in part; *Murrayella* Kofoid 1907 in part.

**Type:** *C. elongatum* Kofoid 1907.

Armored. Large biconical to attenuated cell that is laterally compressed, particularly in the midbody. Hypotheca attenuated into antapical horn where plate sutures or overlap appear as torsion in the horn. Epithea sometimes attenuated into apical horn. Cingulum premedian to median and descending about 1×. The *sa* plate invades the epithea. Theca with little ornamentation to areolate, sometimes hyaline and delicate. Tentative plate formula: Po, 2', 3a, 7'', 5c, ?s, 5''', and 2'''''. Chloroplasts present.

**Remarks:** This genus has been confused with *Murrayella*-like cells and *Murrayella* was synonymized with *Pavillardinium* because it was previously occupied botanically and *Pavillardinium* was synonymized with *Corythodinium*. The total number of plates (no matter the series) differs between *Centrodinium* and *Corythodinium*. Also, it would appear that *Centrodinium* has a Po at the apex and that *Corythodinium* does not have an apical pore plate, but does have an identifiable dorsal epithecal pore.

***Centrodinium elongatum*** Kofoid 1907 (not illustrated)

Cingulum median and descending. Epithea truncate with short horn; hypotheca longer and attenuated into almost cylindrical antapical horn that is gradually curved to the left.

**Distribution:** Tropical waters; Eastern Pacific Ocean.

**Genus *Corythodinium*** Loeblich Jr. & Loeblich III 1966 (<25 spp.)

**Synonyms:** *Pyrgidium* Stein 1883; *Oxytoxum* Stein 1883 in part; *Pavillardinium* De-Toni in part.

**Type:** *C. tessellatum* (Stein) Loeblich Jr. & Loeblich III 1966.

Armored. Small to large biconical to elongate cell with sculptured theca. Cingulum anterior to median and descending about 1–1.5×; cingulum

prominently excavated and with narrow lists. Although the epitheca is shorter than the hypotheca and the cell can be biconical or tapered, the anterior cingular list is almost the same diameter as the posterior cingular list. The sa plate is obovate or angled and prominently invades the epitheca. Plate formula is tentative: Po, 3', 2a, 6'', 5c, 4(?)s, 5''', and 1''''(or 1p). Chloroplasts present.

**Remarks:** This genus is recognized by Balech (1988a) and Sournia, 1986; but Dodge and Saunders (1985a) synonymized it with *Oxytoxum*. Until plate analyses are completed with dissected specimens, these two genera should be kept separate. The apical pore referred to by Dodge and Saunders that always occurs in their 4' may not be a separate apical pore plate but rather a large pore in the 2a. Plate designations vary among authors.

***Corythodinium constrictum*** (Stein) F. J. R. Taylor 1976 (Plate 7)

Small to medium cell. Cingulum premedian; hypotheca exceeds epitheca and ends in an antapical spine. The cell is horizontally constricted about midbody and the postcingular plates have longitudinal striae. Areolae with pores above the constriction differ from the linear pore fields below the constriction.

**Remarks:** No other species to date resembles this species.

**Distribution:** Open water species; warm temperate to tropical waters; worldwide distribution.

***Corythodinium tessellatum*** (Stein) Loeblich Jr. & Loeblich III 1966 (Plate 45)

Medium-sized cell. Cingulum premedian; hypotheca exceeds epitheca and ends in a thick antapical spine. Epitheca with reticulate markings and broad hypotheca with characteristic longitudinal striae connecting evenly spaced, offset horizontal striae. Horizontal striae with linear field of pores on inside margin.

**Distribution:** Warm temperate to tropical waters; most records from the Atlantic Ocean.

**Genus *Oxytoxum*** Stein 1883 (>50 spp.)

**Type:** *O. scolopax* Stein 1883.

Armored. Small to large, needle-shaped to top-shaped cell with a decidedly anterior epitheca that is drastically narrower and shallower than the hypotheca. Cingulum is anterior with little displacement (0–0.5×) and the sa plate barely invades the epitheca. Plate formula is thought to be the same as that for *Corythodinium*, except some authors consider the two anterior intercalaries to be apicals. Certain species less than 15 μm in length, probably less than 10 μm. Chloroplasts present.

**Remarks:** The plate formula and pattern needs to be resolved by separating plates in both the epitheca and the hypotheca. The presence of a possible

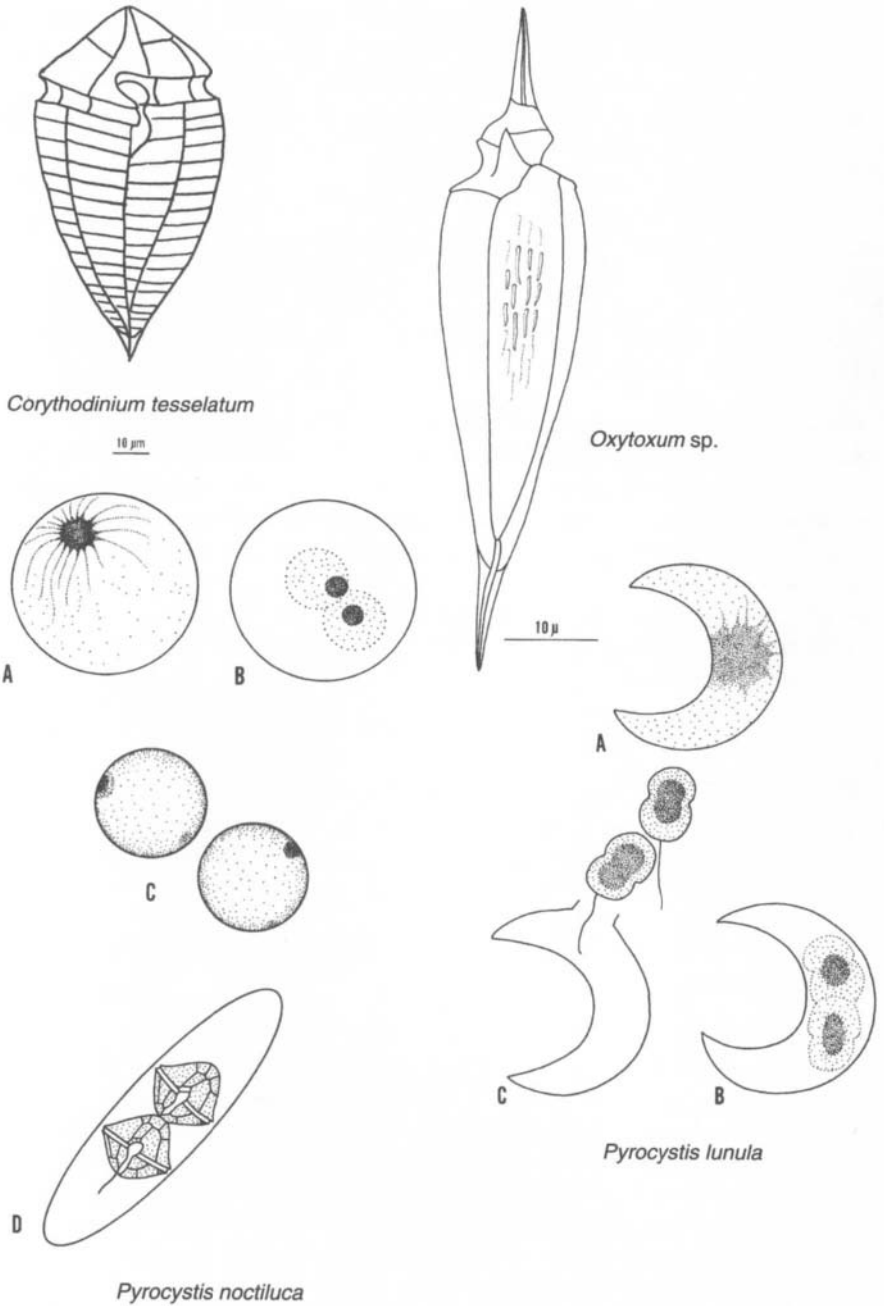

PLATE 45 *Corythodinium tessellatum*, redrawn from Dodge & Saunders (1985a); *Oxytoxum* sp., *Pyrocystis noctiluca* life cycle, and *Pyrocystis lunula* life cycle. Both *Pyrocystis* are redrawn from Elbrächter & Drebes (1978).

apical pore plate needs to be demonstrated in order to assign plate series. The sole antapical plate could be interpreted as a posterior intercalary following Balech's modification of the Kofoidian system.

***Oxytoxum scolopax*** Stein 1883 (Plate 7)

Attenuated, spindle-shaped cell with distinct winged lanceolate apical and antapical spines. Hypotheca with linear rows of cylindrical ridges, each with an anterior pore. Medium-sized species. Plate 45 shows an

*Oxytoxum* sp. illustrated that has similar surface markings to *O. scolopax*.

**Remarks:** One of the most common representatives encountered.

**Distribution:** Warm temperate to tropical waters; worldwide distribution, but more typical of the Atlantic Ocean.

***Oxytoxum variabile*** Schiller 1937 (not illustrated)

Small cell with reduced, almost flat epitheca. The conical hypotheca has a characteristic hook-and-eye linear pattern of curved ridges and anterior pores.

**Distribution:** Oceanic; warm temperate to tropical waters; Pacific and Atlantic Oceans.

**Family Pyrocystaceae** (Schütt) Lemmerman 1899

**Genus *Pyrocystis*** Murray ex Haeckel 1890 (<25 spp.)

**Synonyms:** *Gymnodinium* Stein 1878 in part; *Murraycystis* Haeckel, 1890; *Diplodinium* Klebs 1912 in part; *Dissodinium* Klebs in Pascher 1916 in part. **Type:** *P. noctiluca* Murray ex Haeckel 1890.

**References:** Swift & Durbin, 1971; Swift & Wall, 1972; F. J. R. Taylor, 1972; Elbrächter & Drebes, 1978; Pinceman & Gaylor, 1978; Drebes, 1981; Pinceman et al., 1981, 1982; Sournia, 1986; Elbrächter et al., 1987; Fensome et al., 1993.

Unarmored and/or armored depending on life history stage. Dominant vegetative stage is a large, planktonic bladder-shaped cell. The nonflagellated bladder cell which has been called a coccoid stage can be spherical, fusiform, lanceolate, or crescent shaped. Smaller reproductive stages can be armored, biflagellated planospores resembling *Alexandrium* or unarmored nonflagellated, uniflagellated, or biflagellated cells, some of which resemble *Gymnodinium*. Plate formula of armored stages is the same as that for *Alexandrium*. Typically, one or two spore stages are produced within the mother cell and start with contraction of the cytoplasm. Shape of the nucleus of all stages is sausage to horseshoe shaped. Chloroplasts present in all stages. Bioluminescent.

**Remarks:** Genus has been confused with *Dissodinium*, a genus of planktonic, parasitic dinoflagellates with primary and secondary cyst stages. However, the two genera can easily be distinguished because *Dissodinium*

cysts have large vacuoles and parietal cytoplasm and a spherical nucleus. The primary cyst, which is spherical, produces 2 to more than 16 smaller secondary cysts (usually lunate) within the mother cell. Each secondary cyst produces five or more biflagellated dinospores (gymnodinialean).

*Dissodinium* stages can be pigmented. Also, Elbrächter et al. (1987) documented extreme intraspecific morphological variation in the lunate bladder cell stage and suggested that only four species could be identified with reasonable certainty: *P. minima*, *P. gerbaultii*, *P. obtusa*, and *P. robusta* if certain characters were present. These authors further suggested that the remaining lunate specimens should be listed as belonging to the *P. lunula* species complex or the *P. acutallanceolata* species complex.

***Pyrocystis noctiluca* Murray ex Haeckel 1890 (Plate 45)**

**Synonyms:** *P. pseudonociluca* Wyville-Thomson in J. Murray, 1876;

*Dissodinium pseudolunula* Swift ex Elbrächter & Drebes 1978.

Dominant vegetative stage is large spherical or subspherical cell, greater than 350  $\mu\text{m}$  in diameter when fully developed. However, after release from armored planospore, nonmotile cell can be less than 200  $\mu\text{m}$  in diameter. Produces one or two biflagellated armored cells that resemble *Alexandrium*. More commonly produces unarmored aplanospores that are smaller spheroidal cells which are released and grow to a larger size. Spherical cell without large central food vacuole, but with radiating cytoplasm.

**Remarks:** Spherical primary cysts of *Dissodinium* are typically less than 200  $\mu\text{m}$  and typically have food vacuoles.

**Distribution:** Oceanic species; cosmopolitan in warm temperate to tropical waters.

***Pyrocystis lunula* (Schütt) Schütt 1896 (Plate 45)**

Large-sized lunate cell that produces "gymnodinioid" swarmers or planospores.

**Remarks:** This species represents a species complex and field specimens are difficult to identify unless they are cultured. Elbrächter et al. (1987) suggest that only the lunate *P. minima* and *P. gerbaultii* can be identified based on size and shape.

**Distribution:** Oceanic and coastal. Warm temperate to tropical?

**Family Pyrophacaceae Lindemann 1928**

**Genus *Fragilidium* Balech ex Loeblich III 1965 (<10 spp.)**

**Synonyms:** *Helgolandinium* von Stosch 1969; *Goniodoma* Stein 1883 in part.

**Type:** *F. heterolobum* Balech ex Loeblich III 1965.

**References:** Balech, 1959b, 1988b, 1990a; von Stosch, 1969b; Steidinger & Williams, 1970; Dodge, 1982; Sournia, 1986; Fensome et al., 1993.

Armored. As the genus suggests, the cells are fragile and thinly thecate. Under stress, ecdysis is common and the thecal plates can appear as a fragmented halo surrounding the protoplast or the theca can separate at the cingulum. Cell globular, subglobular or spherical in shape; small to medium-sized cell. Cingulum equatorial and descending less than  $1\times$ . Plate formula: Po, cp, 4 or 5', 7–9", 9–11c, 6–8s, 7 or 8", 1p, and 2". Chloroplasts present and two species known to be phagotrophic as well.

**Remarks:** Interpretation of plates differs among authors. The 1" can easily be considered a displaced 1' as in *Alexandrium* or in *Goniodoma*; even the APC has affinities with *Alexandrium* because of the comma-shaped pore with a closing plate. The questions become does this belong in the Pyrophacaceae or the Goniodomataceae and whether or not *Helgolandinium* with the slit and ventral pore in the plate over the sa is distinct from *Fragilidium*. The slit in *F. subglobosum* represents the anterior edge of a small precingular plate, while the slit in *F. mexicanum* is just a slit with a terminal vp as in some of the *Alexandrium*. The 1'(1") of this genus can resemble the 1' of *Goniodoma* or *Alexandrium*. The sa is also of the *Alexandrium* type. Knowing plate overlap patterns would help resolve the question of which plate is 1'.

***Fragilidium heterolobum* Balech ex Loeblich III 1965 (Plate 4)**

Medium-sized cell. The 1' is of the *Goniodoma* type and the two antapical plates are dissimilar in size. The species is distinguished by its antapical profile and a prominent left antapical lobe.

**Distribution:** Coastal; warm temperate to tropical waters; Pacific and Atlantic Oceans.

***Fragilidium fissile* Balech 1990 (not illustrated)**

Medium sized spherical cell with broad Po and no vp in the 1'(1"). 1' plate of *Alexandrium* type; two antapical plates of dissimilar size.

**Remarks:** Although this species is similar to *F. subglobosum*, it differs by not having a vp and it lacks the small precingular plate above the left margin of the sa, rather, the 1'(1") sits directly above the sa

**Distribution:** Recently described species of unknown distribution beyond the type locality of the Gulf of Salerno, Tyrrhenian Sea.

***Fragilidinium mexicanum* Balech 1988 (Plate 46)**

Medium-sized broadly conical cell. Cingulum displaced  $<1\times$ . Displaced 1' with slit and ventral pore. Five apical plates and seven precingulars depending on interpretation. 1p and 7" present.

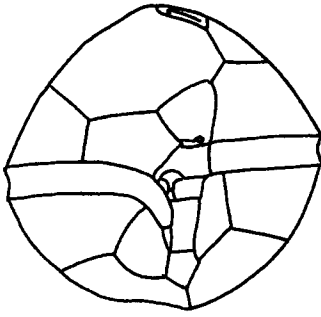

*Fragilidium mexicanum*

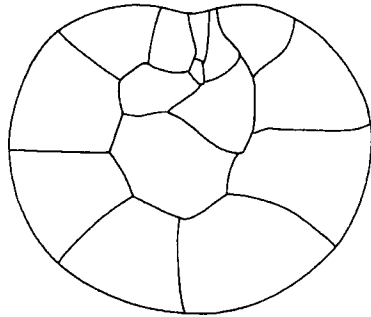

*Pyrophacus horologium*

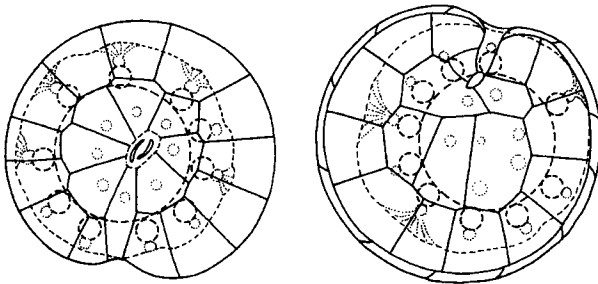

*Pyrophacus steinii*

PLATE 46 *Fragilidium mexicanum* redrawn from Balech (1988b); *Pyrophacus horologium* and *P. steinii* redrawn from Matsuoka (1985). Scale = 10  $\mu\text{m}$ .

**Remarks:** Differs from *F. heterolobatum* in shape and plate pattern.

**Distribution:** Known from the type locality Mexican coastal waters.

**Genus *Pyrophacus*** Stein 1883 (<5 spp.)

**Type:** *P. horologium* Stein 1883.

**References:** Schiller, 1937; Steidinger & Davis, 1967; Steidinger & Williams, 1970; Wall & Dale, 1971; F. J. R. Taylor, 1976; Balech, 1979b, 1980, 1988a.

Armored. Large biconical to lens-shaped cells, sometimes polar axes oblique. Cingulum narrow, equatorial, and slightly descending. Sulcus short. Theca granulate with pores and growth striae. Plate formula: Po, cp(?), 5–9', 0–8a, 7–15", 9–16c, 8s, 8–17"', 0–15p, and 3'''; follows Balech's 1980 change to Kofoid's designation of antapical plates.

Chloroplasts present. Fossil and extant cysts known.

**Remarks:** Most variable genus for plate tabulation. In the Gonyaulacales and Peridiniales, the hypotheca is typically the more conservative half of the cell in plate pattern and tabulation. However, in *Pyrophacus* the reverse is true, the epitheca is more conservative. Cyst types vary from tuberculate to agglutinous in extant species and Wall and Dale (1971) speculated on fossil representation of agglutinous types.

***Pyrophacus horologium*** Stein 1883 (Plates 5 and 46)

Biconical cell. Most conservative species with little variation in plate formula. Typically the epitheca has 5', 0a, and 9'.

**Distribution:** Oceanic, neritic, estuarine. Cosmopolitan in cold temperate to tropical waters.

***Pyrophacus steinii*** (Schiller) Wall & Dale 1971 (Plates 5 and 46)

Flattened, lenticular cell with attenuated epitheca. Typically, the epitheca has 7', 0a, and 12'.

**Distribution:** Restricted to warm temperate to tropical waters of all oceans.

**Order Peridiniales** Haeckel 1894

**References:** Schiller, 1937; Loeblich III, 1982; Sournia, 1986; Fensome et al., 1993.

Armored dinokonts of varied form. Plate tabulation is usually diagnostic. If the Thecadiniaceae is set aside from the other families in this order, then the APC typically has an X plate, 3–6', typically only 3 or 4', 1–3a, 6 or 7'', 4–6c, 4–6s, 5''', and 1 or 2'''' but typically 2'''. The 1' is usually more symmetrical than that in the Gonyaulacales.

**Family Calciodinellaceae** F. J. R. Taylor 1987

**Genus *Enciculifera*** Balech 1967 (<5 spp.)

**Type:** *E. mexicana* Balech 1967



**References:** Balech, 1967, 1980, 1988; Cox & Arnott, 1971; Dale, 1978; Indelicato & Loeblich III, 1986; Sournia, 1986; Matsuoka et al., 1990.

Armored, small scrippsielloid cells with a conspicuous apical process.

Photosynthetic. Plate formula: Po, X, 4', 3a, 7'', 5c (4c + t), 5s, 5''', and 2'''. The 1c or t plate with characteristic long, anteriorly directed lance-like spine called the ensiculus. sp plate not in contact with cingulum.

Chloroplasts present. Produces calcareous, spherical cysts.

**Remarks:** See *Scrippsiella*. The confusion with this genus centers around the description of the type species which was originally illustrated with 4c plates. However, newly described species all have had the characteristic 5c with the lc or t plate having a long spine internal to the precingular series.

*Ensiculifera mexicana* Balech 1967 (Plate 47)

**Description:** Same as that for genus.

**Distribution:** Gulf of Mexico.

*Ensiculifera carinata* Matsuoka, Kobayashi, & Gains 1990 (not illustrated)

Cell body elongate with conical epitheca and concical, laterally asymmetric hypotheca. Ensiculus sigmoid, more than half the length of the 1'. Small antapical spine (carina) at the juncture of the sp, 1''', and 2''''.

**Remarks:** This species is differentiated by the presence of an antapical spine and cell shape.

**Distribution:** Temperate and tropical coastal waters.

**Genus** *Pentapharsodinium* Indelicato & Loeblich III 1986 (<5 spp.)

**Type:** *P. dalei* Indelicato & Loeblich III 1986.

**References:** Dale, 1977b; Indelicato & Loeblich III, 1986; Horiguchi & Pienaar, 1991; Lewis, 1991; Montresor et al., 1993.

Armored, small peridinioid cells similar to other genera in this family and producing organic and calcareous cysts. Plate formula: Po, X, 4', 3a(2a?), 7'', 5c (4 + t), 4s, 5''', and 2'''. The sp plate does not contact the cingulum.

**Remarks:** The placement of this genus in this family is tentative. Also, the species *Protoperidinium quinquecorne* may belong in this genus based on five cingular and four sulcal plates with the sp not touching the cingulum; however, it has only two anterior intercalary plates and was recently transferred to *Peridinium* by Horiguchi & Pienaar (1991). The type species for *Peridinium* lacks an APC which is a distinctive generic character and therefore this species should not be assigned to *Peridinium*. It may be that the generic description for *Pentapharsodinium* should be emended to accommodate 2a.

*Pentapharsodinium dalei* Indelicato & Loeblich III 1986 (not illustrated)

**Synonym:** *Peridinium faeroense* sensu Dale 1977.

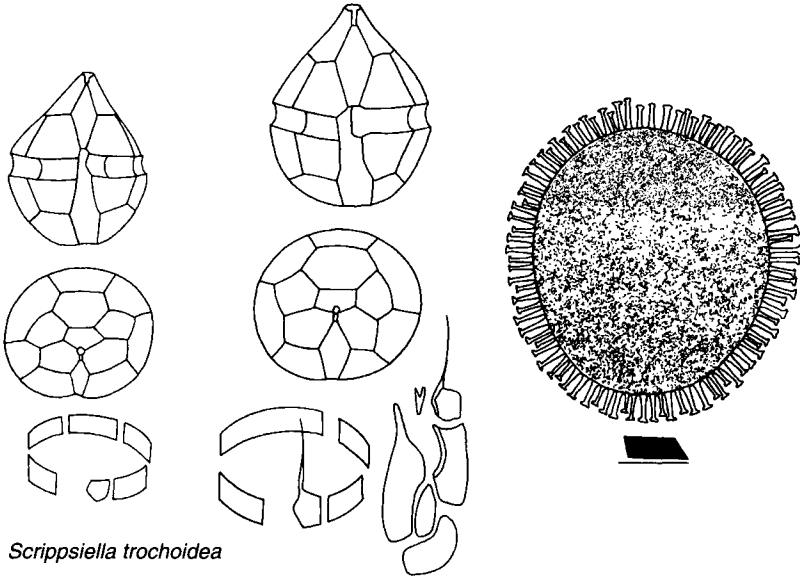

*Scrippsiella trochoidea*

*Enciculifera* sp.

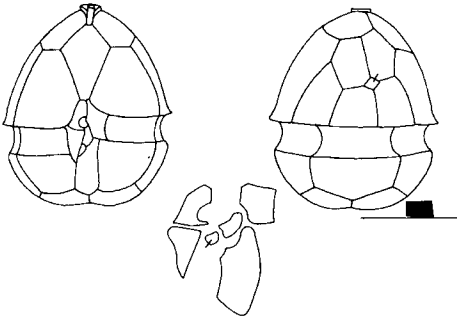

*Scrippsiella precaria*

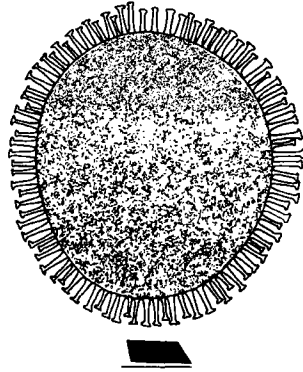

*Pentapharsodinium tyrrhenicum*

PLATE 47 *Scrippsiella trochoidea* and *Enciculifera* sp. redrawn from Balech (1980); *Scrippsiella precaria* redrawn from Montesor & Zingone (1988); *Pentapharsodinium tyrrhenicum*. Scale = 10  $\mu$ m.

Cell with distinctive thecal pores surrounded by concentric rings. *P. tyrrhenicum* (see Plate 47) lacks concentric rings around the pores.

**Distribution:** Temperate coastal areas.

**Genus** *Scrippsiella* Balech ex Loeblich III 1965 (<25 spp.)

**Type:** *S. sweeneyae* Balech ex Loeblich III 1965.

**References:** Balech, 1963, 1988a; Dale, 1977b; Steidinger & Balech, 1977; Loeblich et al., 1979; Indelicato & Loeblich III, 1985; Montresor & Zingone, 1988; Horiguchi & Pinenaar, 1988; Gao et al., 1989a,b; Akselman & Keupp, 1990; Matsuoka et al., 1990; Gao & Dodge, 1991; Honsell & Cabrini, 1991; Lewis, 1991; Banaszak et al., 1993.

Armored, small (<50  $\mu\text{m}$ ) characteristic peridinioid cells that occur in either planktonic or benthic habitats or both depending on adaptive behavior. One species is symbiotic. Photosynthetic with some species being mixotrophic and possessing a peduncle. Some species are capable of attaching to substrates by mucoid strands. Thecal markings vary from pores to reticulations to striae to papillae. Plate formula: Po, X, 4', 3a, 7", 6c (5 + t), 4 or 5s, 5''' and 2'''. sp plate touches cingulum. APC typical for genus; x plate varies in length. Some species with an apical process.

Produces calcareous cysts and possibly organic cysts.

**Remarks:** This genus is similar to *Peridinium*, *Proto-peridinium*, *Pentapharsodinium*, *Enciculifera*, and *Thompsodinium*, but is separable by plate tabulation and APC. Much synonymy among these genera exists; for example, *Enciculifera* has been lumped by some taxonomists into *Scrippsiella* while *S. trochoidea*, the most common species in the genus, was previously known as a *Peridinium*. Although there are some *Scrippsiella* described with 4s plates and others with 5s, the sm plate is easily missed and would result in 4s being recorded. The APC needs further study to determine if all species have three segments to the apical collar (Toriumi & Dodge, 1993). Species of this genus can have variant plate formulae in cultured specimens; they can produce additional plates in known series. Currently, species are differentiated based on the following characters: size and shape, shape of 1' and 2a, number of precingular plates, surface ornamentation, the presence of stigma, and habitat.

***Scrippsiella precaria*** Montresor & Zingone 1988 (Plates 6 and 47)

Planktonic. Oval cell with conical epitheca and truncate hypotheca.

Epitheca exceeds hypotheca and cingulum is displaced about two-thirds of the width. Theca thin with scattered small pores. Produces spiny calcareous cysts.

**Remarks:** This species is differentiated by its small 2a plate which is diamond shaped and sits between the 1a, 3a, 4", and 5" on the dorsal side.

**Distribution:** Originally described from the Gulf of Naples, Italy.

***Scrippsiella subsalsa*** (Ostenfeld) Steidinger & Balech 1977 (not illustrated)

Epitheca conical and hypotheca trapezoidal; epitheca and hypotheca almost equal. Cell compressed dorsoventrally and longitudinal axis oblique. The 2a and 3a are separated by the 3'. Theca lightly reticulate; reticulae can appear as longitudinal striae.

**Remarks:** Some of the benthic *Scrippsiella* should be taxonomically separated from the planktonic species based on sulcal plates, noncontact of 2a and 3a, and the APC. One of the characters of *Scrippsiella* is that the ps plate touches the cingulum. In *S. subsalsa*, *S. caponii* (= *S. gregaria*), and *S. arenicola* this is not the case.

**Distribution:** Benthic/epiphytic; tychoplanktonic. Cosmopolitan in warm temperate and tropical estuaries and coastal areas.

***Scrippsiella trochoidea*** (Stein) Loeblich III 1976 (Plates 6 and 47)

Conical epitheca with short, convex apical process and collar; round hypotheca. 1' is very narrow and slightly asymmetrical. Produces calcareous cysts.

**Remarks:** This species is differentiated by its pear shape, narrow 1', and apical process. It is very similar to *S. mimima*, which is smaller, and both have 5s, but they differ in sulcal plate pattern and cingular plate location.

**Distribution:** Cosmopolitan neritic and estuarine species. This is the most commonly recorded planktonic scrippsielloid dinoflagellate.

**Family Kolkwitziellaceae** Lindemann 1928

**References:** Lebour, 1925; Schiller, 1937; Abé, 1941, 1981; Balech, 1964a, 1988; Steidinger & Williams, 1970; F. J. R. Taylor, 1976; Dodge & Hermes, 1981; Sournia, 1986; Matsuoka, 1988; Lewis, 1990; Dale et al., 1993; Dodge & Toriumi, 1993; Elbrächter, 1993; Toriumi & Dodge, 1993.

**Remarks:** This is a confused group of distinctive species. The confusion arises from interpretation and assignment of plates to a series and the extensive synonymy involved in tracking a single species.

**Genus *Boreadinium*** Dodge & Hermes 1981 (<5 spp.)

**Type:** *B. pisiforme* Dodge & Hermes 1981.

Armored. Small sublenticular to subspherical cell with APC and prominent left sulcal list typical of diplopsalids. Cingulum median and circular. Surface with scattered pores. Chloroplasts absent. Plate formula: Po, X, 4', la, 7'', 4(3+t)c, 5(?)s, 5''', and 1'''. Meta. APC of C' type.

***Boreadinium pisiforme*** Dodge & Hermes 1981 (Plate 48, schematic)

**Distribution:** Coastal; cold temperate.

**Genus *Diplopelta*** Stein ex Jørgensen 1912

**Type:** *D. bomba* Stein ex Jørgensen 1912.

**Synonym:** *Dissodium* Abé 1941 in part.

Armored. Small to medium-sized spherical cell with APC and prominent left sulcal list as in other diplopsalids. Cingulum median and circular.

Surface with scattered pores. Chloroplasts absent. Plate formula: Po, X, 4,

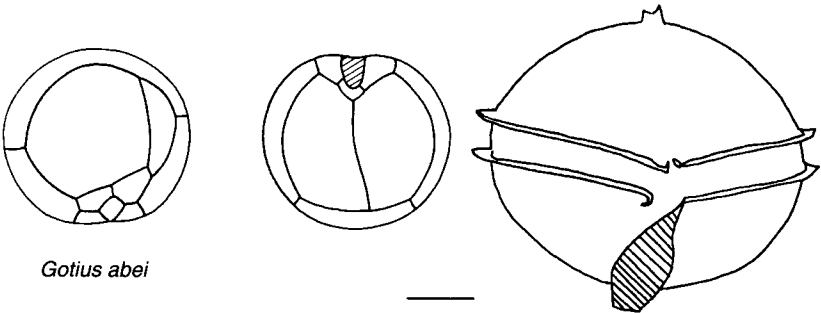
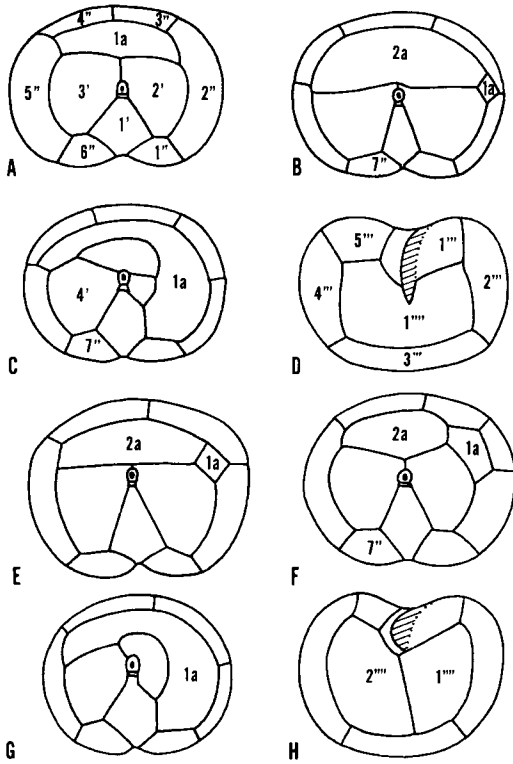

PLATE 48 (A-H) Schematics redrawn from Dodge & Hermes (1981). (A) *Diplopsalis*; (B) *Preperidinium*; (C) *Boreadinium*; (D) hypotheca of A-C; (E) *Diplopelta*; (F) *Diplopsalopsis*; (G) *Oblea*; (H) hypotheca of E-G; *Gotius abei* redrawn from Abé (1981); *Diplopsalis* ventral view with prominent protruding left sulcal list. (Scale = 10  $\mu$ m).

1a, 6", 4(3+t)c, 6(?)s, 5"', and 2'''. An alternate formula is 3' and 2a.  
Ortho. APC of D' type. Produces cysts.

***Diplopelta parva*** (Abé) Matsuoka 1988 (Plate 48, schematic)

Synonym: *Dissodinium parvum* Abé 1941

Distribution: Coastal; temperate.

Genus ***Diplopsalis*** Bergh 1881 (<5 spp.)

Synonyms: *Dissodinium* Abé 1941 in part; *Glenodinium* Ehrenberg 1836 in part.

Type: *D. lenticula* Bergh 1881.

Armored. Medium-sized subspherical to lenticular cell with APC and prominent left sulcal list typical of diplopsalids. Surface with scattered pores. Chloroplasts absent. Plate formula: Po, X, 3', 1a, 6", 4(3+t)c, 5s, 5"', and 1'''. Ortho. APC of D' type. Produces cysts.

***Diplopsalis lenticula*** Bergh 1881 (Plate 48, schematic)

Distribution: Estuarine to oceanic; cosmopolitan in cold temperate to tropical waters.

Genus ***Diplopsalopsis*** Meunier 1910 (<5 spp.)

Type: *D. orbicularis* (Paulsen) Meunier 1910.

Armored. Small to medium-sized subspherical cell with APC and prominent left sulcal list of diplopsalids. Surface with scattered pores. Chloroplasts absent. Plate formula: Po, X, 4', 1a, 7", 4(3+t)c, 6(?)s, 5"', and 2'''. An alternate formula is 3' and 2a. Ortho. APC of D' type. Produces cysts.

***Diplopsalopsis orbicularis*** (Paulsen) Meunier 1910 (Plate 48, schematic)

Distribution: Pacific Ocean, North Sea, English Channel, and Danish waters.

Genus ***Gotoius*** Abé ex Matsuoka 1988 (<5 spp.)

Type: *G. mutsuensis* Abé 1981.

Armored. Medium-sized subspherical to lenticular cell with median, slightly ascending cingulum and small left sulcal list. Surface with scattered pores. Chloroplasts absent. Plate formula: 4', 1a, 6", 4(3+t)c, 5s, 5"', 2'''; no Po and X. Large 3' epithelial plate. Ortho. Produces cysts.

Remarks: The large 3' plate was described as a 2a plate but it appears to be homologous to 3'.

***Gotoius abei*** Matsuoka 1988 (Plate 48)

Subspherical cell. Large apical plates.

Distribution: Recently described from Japanese waters.

Genus ***Oblea*** Balech ex Loeblich Jr. & Loeblich III 1966 (<5 spp.)

Type: *O. baculifera* Balech ex Loeblich Jr. & Loeblich III 1966.

Armored. Small to medium-sized, globulose or sublenticular cell with apical pore complex. Prominent left sulcal list as with other diplopsaloids. Cingulum circular to slightly ascending. Surface with scattered pores. Typically without chloroplasts. Plate formula: Po, X, 3', 1a, 6'', 4(3+t)c, 6(?)s, 5''', and 2'''. Meta 1'. APC of D'. Produces cysts.

*Oblea baculifera* Balech ex Loeblich Jr. & Loeblich III 1966 (Plate 48, schematic)

**Remarks:** Smaller warm water forms exist.

**Distribution:** Cold water species; South Atlantic Ocean and North Pacific Ocean.

**Genus *Preperidinium*** Mangin 1913 (<5 spp.)

**Synonyms:** *Diplopeltopsis* Pavillard 1913; *Zygabikodinium* Loeblich Jr. & Loeblich III 1970.

**Type:** *P. meunieri* (Pavillard) Elbrächter 1993.

Armored. Small to medium-sized sublenticular to subglobular cell with prominent left sulcal list and APC. Cingulum median and circular with prominent rib-supported lists. Surface with scattered pores. Chloroplasts absent. Plate formula: Po, X, 4', 1a, 7'', 4c(3+t), 5s, 5''', and 1'''. An alternate formula is 3' and 2a. Ortho. APC of D' type. Produces cysts.

*Preperidinium meunieri* (Pavillard) Elbrächter 1993 (Plate 48, schematic)

**Synonyms:** *Peridinium paulsenii* Mangin 1911; *Diplopsalis minor* (Paulsen) Lindemann 1927; *Zygabikodinium lenticulatum* Loeblich Jr. & Loeblich III 1970.

**Distribution:** Coastal and estuarine. Temperate to tropical waters; cosmopolitan.

**Family Peridiniaceae** Ehrenberg 1828

**Genus *Heterocapsa*** Stein 1883 (<10 spp.)

**Synonym:** *Cachonina* Loeblich III 1968.

**Type:** *H. triquetra* (Ehrenberg) Stein 1883.

**References:** Loeblich III, 1968; von Stosch, 1969a; Balech, 1977a; Loeblich et al., 1981; Morrill & Loeblich III, 1981a,b, 1983; Pomroy, 1989.

Armored. Small (<20  $\mu\text{m}$ ) peridinioid that appears unarmored at the light microscope level of resolution. Epitheca rounded to conical; hypotheca rounded to attenuated. Cingulum slightly displaced and descending. Thinly thecate with characteristic body scales. Chloroplasts present. Most typical plate formula: Po, cp, X, 6', 3a, 7'', 6c, 5s, 5''', 0 or 1p, 2'''. The 1' is displaced from the Po and lies above the sa. The sa plate is small. The X plate is at the anterior left margin of the 6' and in contact with the Po. Species can be bloom formers.

**Remarks:** This genus has been confused with *Gymnodinium*, *Glenodinium*, and *Katodinium* because plates were not initially detected. The plate formula can differ based on different authors' interpretations of plates; for example, Loeblich et al. (1981) give it as Po, cp, 5', 3a, 7'', 6c, 5(7?)s, 5''', and 2''' for *H. pygmaea*. If you add the work of Morrill and Loeblich III (1981) for *H. triquetra*, the formula would be increased by 1p. The latter authors also demonstrated extreme variation in plate tabulation of cultured specimens. One major interpretation of most authors is that the central plate right above the anterior-most sulcal plates is the sa; however, it is presented here as a displaced 1' above a very small and cryptic sa. See Morrill and Loeblich III (1984) for the application of division lines in supporting their position for the sa plate.

*Heterocapsa niei* (Loeblich) Morrill & Loeblich III 1981 (Plates 6 and 49)

Synonym: *Cachonina niei* Loeblich 1968

Epitheca and hypotheca equal; slightly compressed dorsoventrally.

**Distribution:** Estuarine and neritic; cosmopolitan in temperate and tropical waters, often forms spring through fall blooms.

*Heterocapsa triquetra* (Ehrenberg) Stein 1883 (Plates 6 and 49)

Hypotheca attenuated into horn and with 1p plate.

**Distribution:** Neritic, estuarine, brackish water, marine, and in some low-salinity water; worldwide distribution.

**Genus *Peridinium*** Ehrenberg 1832

**Type:** *P. cinctum* (O. F. Müller) Ehrenberg 1832.

**References:** Schiller, 1937; Boltovskoy, 1975; Carty & Cox, 1986; Sournia, 1986; Popovsky & Pfister, 1990; Elbrächter, 1993; Fensome et al., 1993.

Armored. Small to medium-sized cell of varied shape from spherical to ovoid to lenticular. Type species without an APC. Surface markings varied. Plate formula: 4', 3a, 7'', 5c, 5s, 5''', and 2'''.

**Remarks:** This genus, which is principally freshwater or brackish, is confused as is *Glenodinium*, *Glenodiniopsis*, *Durinskia*, *Peridiniopsis*, *Kryptoperidinium*, *Kansodinium* and the diplopsalids. As an example, the species *Kolkwitzziella acuta* (Apstein) Elbrächter 1993 has the following synonymy: *Glenodinium acutum*, *Diplopsalis acuta*, *Peridinium latum*, *Entzia acuta*, *Apsteinia acuta*, *K. gibbera*, and others. Recently, Fensome et al. (1993) redefined *Glenodinium* (type species *G. cinctum*) and used the family Glenodiniaceae Wiley & Hickson 1909 for *Glenodinium* and *Glenodiniopsis*, which were characterized as having chloroplasts and the plate formula 4', 4a, 7 or 8'', 6''', and 2'''.

*Peridinium cinctum* (O. F. Müller) Ehrenberg 1832 (not illustrated)

**Distribution:** Freshwater; worldwide.



Heterocapsa

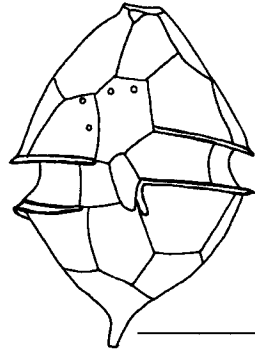
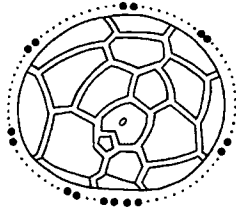
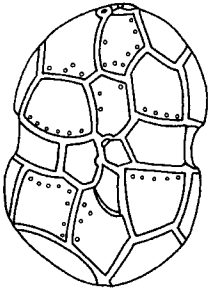

*Heterocapsa niei*

*Heterocapsa triquetra*

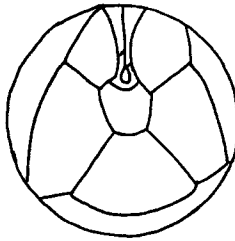
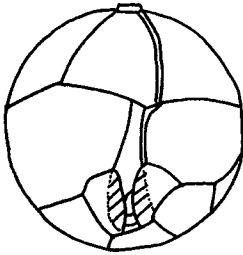

schematic *Blepharocysta*

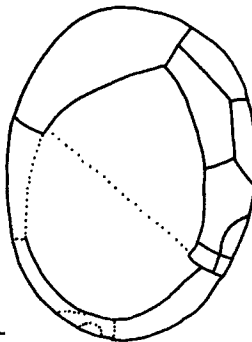
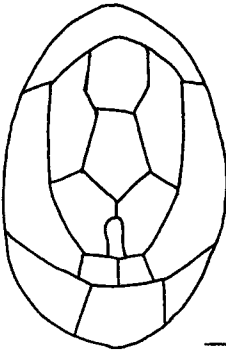

*Lissodinium schilleri*

PLATE 49 *Heterocapsa niei* redrawn from von Stosch (1969); *Heterocapsa triquetra*; Schematic *Blepharocysta* redrawn from Carbonell-Moore (1992); *Lissodinium schilleri* redrawn from Carbonell-Moore (1993). Scale = 10  $\mu$ m.

**Family Podolampaceae Lindemann 1928**

**References:** Nie, 1939, 1942; Schiller, 1937; Balech, 1963; Abé, 1966; Steidinger & Williams, 1970; F. J. R. Taylor, 1976; Dodge, 1982; Sournia, 1986; Carbonell-Moore, 1991, 1992, 1993a,b; Fensome et al., 1993.

**Genus *Blepharocysta* Ehrenberg 1873 (<10 spp.)**

**Type:** *B. splendor-maris* (Ehrenberg) Ehrenberg 1873.

Armored. Medium-sized cell, spherical or subspherical to oval without apical attenuation. Homologous cingular area not excavated and cell without cingular lists but with sulcal lists. Plate formula: Po, cp, X, 3', 1a, 5'', 3c, 4 or 5s, 4 or 5''', and 1'''''. Postcingular plates without prominent double pore tract as in *Podolampas*. Plate pore patterns may help in differentiating species. At least four species can be distinguished by general shape and shape and position of sulcal lists in lateral view. Chloroplasts present.

***Blepharocysta splendor-maris* (Ehrenberg) Ehrenberg 1873 (Plates 7 and 49 schematic)**

APC diagnostic for genus, maybe slight species differences. Cingular plates large. Sulcal lists curved, adjacent to antapex. Megacytic areas can be wide with striae on advancing side of plate overgrowth.

**Distribution:** Oceanic to coastal, warm water species.

**Genus *Lissodinium* Matzenauer emend. Carbonell-Moore 1991 (<25 spp.)**

**Synonym:** *Blepharocysta* Ehrenberg 1873 in part.

**Type:** *L. schilleri* Matzenauer emend. Carbonell-Moore 1991.

Armored. Medium-sized lentil-shaped cell without a defined cingulum as in the family but without antapical spines and with a strong lateral compression. Plate formula: Po, cp, X, 3', 1a, 5'', 3c, 5s, 5''', and 1'''''. The apical pore complex is characteristic of the genus with an apical spine originating from the center of the Po. The collar or rim of the Po is lower than the outside apical plate flanges, while in *Blepharocysta* the Po rim can be higher than the outside overlapped flanges. Chloroplasts present.

**Remarks:** Species of this genus are differentiated based on the following characters: cell size and shape, plate size and shape e.g., 1a, 2'', 4'', the presence or absence of spines, and type of surface markings. See Carbonell-Moore (1993) for a taxonomic key.

***Lissodinium schilleri* Matzenauer 1933 (Plates 7 and 49 schematic)**

**Description:** Same as that for genus.

**Distribution:** Oceanic, subtropical to tropical waters.

**Genus *Podolampas*** Stein 1883 (<10 spp.)

**Synonym:** *Parrocelia* Gourret 1883.

**Type:** *P. bipes* Stein 1883.

Armored. Large, pear- or top-shaped cell with attenuated epitheca and one to three prominent antapical spines. Homologous nonexcavated cingular area with three plates and no cingular lists. Plate formula: Po, cp, X, 3', 1a, 5'', 3c, 4–6s, 5''', and 1'''. 1a four-sided and small. Antapical plate very small and difficult to discern. Postcingular plates with a prominent double pore tract. Most species can be separated by shape and characters associated with the winged antapical spines. Chloroplasts present.

**Remarks:** The APCs of *Podolampas*, *Blepharocysta*, and *Lissodinium* are different as are the sulcal and antapical areas. *Blepharocysta* has a left and right sulcal list, *Podolampas* has only a left sulcal list, and the type species of *Lissodinium* has no membraneous sulcal lists although the 1''' and 5''' develop a thickened rim that borders the sulcus as would sulcal lists.

***Podolampas bipes*** Stein 1883 (Plate 7)

Pyriiform cell with two prominent, winged antapical spines that recurve.

The right spine diverges from the cell. Widest point of cell is postmedian.

**Distribution:** Oceanic; warm temperate to tropical waters; worldwide distribution.

***Podolampas elegans*** Schütt 1895 (not illustrated)

Prominent attenuated epitheca and cell with two long, diverging antapical spines. Spines with wings and wings connected by median wing. More divergent, right antapical spine appears shorter than left.

**Distribution:** Oceanic; subtropical to tropical waters; worldwide distribution.

***Podolampas palmipes*** Stein 1883 (Plate 50)

Narrow podolampoid cell with two unequal antapical spines that are winged and not connected. The right spine is slightly divergent and about half the length of the left. There can be a tooth-like projection at the apex, dorsally situated and perhaps associated with one of the apical plates.

**Distribution:** Oceanic; warm temperate to tropical waters; worldwide distribution.

**Family Protoperidiniaceae** F. J. R. Taylor 1987

**Genus *Protoperidinium*** Bergh 1881 (>250 spp.)

**Synonyms:** *Peridinium* Ehrenberg 1832 in part; *Archaeoperidinium* Jörgensen 1912; *Congruentidium* Abé 1927; *Minuscula* Lebour 1925; *Properidinium* Meunier 1919; *Glenodinium* in part.

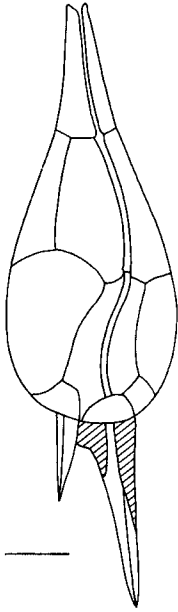

*Podolampas palmipes*

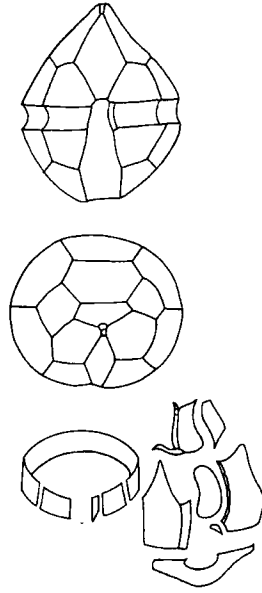

schematic *Protoperidinium*

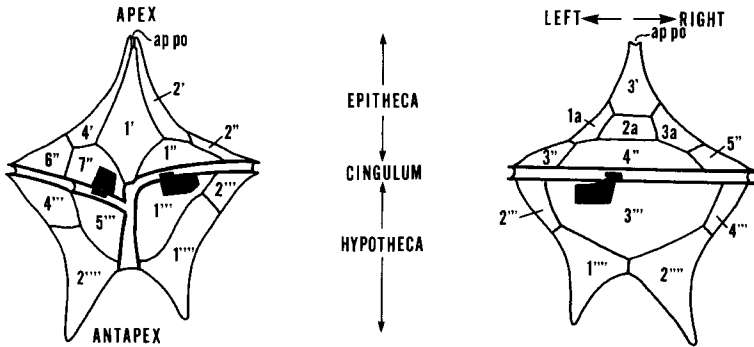

schematic *Protoperidinium*

PLATE 50 *Podolampas palmipes* (scale = 10  $\mu$ m) and schematic of *Protoperidinium* after Balech (1980); schematic of *Protoperidinium* redrawn from Eaton (1980) showing orientation of cell.

**Type:** *P. pellucidum* Bergh 1881.

**References:** Abé, 1936a,b, 1981; Balech, 1951, 1964c, 1973a, 1974, 1976a, 1979c, 1988a; Wall & Dale, 1968; Steidinger & Williams, 1970; Subrahmanyam, 1971; F. J. R. Taylor, 1976; Dodge, 1982, 1983, 1985; Balech et al., 1984; Lewis et al., 1984; Sournia, 1986; Borgese, 1987; Zingone & Montresor, 1988; Fensome et al., 1993; Toriumi & Dodge, 1993.

Armored. Small to large cell of varied shape. Many species with apical and antapical horns or antapical spines. Cingulum usually equatorial with or without displacement; descending or ascending. Surface markings varied from poroids to spines to areolae. Most species without chloroplasts; heterotrophic. Typical plate formula: Po, X, 4', 2 or 3a, 7'', (3+t)c, 6s, 5''', and 2'''. Several species previously in *Minuscula* and *Glenodinium* with six precingulars. One (possibly more) species with seven sulcal plates; one species lacks an APC. Shapes of plates 1' and 2a can be diagnostic to group, as can the APC. Some species produce characteristic cysts.

**Remarks:** Species of this genus are differentiated based on the following characters: cell size and shape, body contour, shape of 1' and 2a, shape and position of plates, cingulum displacement, the presence of horns or spines, type of apical pore complex, and surface markings.

***Protoperidinium brevipes*** (Paulsen) Balech 1974 (Plate 54)

Small cell with pentagonal body shape; rounded triangle in cross section; as deep as wide. Hypotheca indented, slightly bilobed with two short antapical spines. Surface with short spines or papillae. Meta, quadra. Cingulum ascending 0.5×.

**Remarks:** Can be confused with *P. metananum* which is circular in cross section.

**Distribution:** Coastal cold water species.

***Protoperidinium claudicans*** (Paulsen) Balech 1974 (Plate 51)

Thinly thecate medium-sized cell; broadly pyriform with antapical horns. Dorsoventrally compressed. Epitheca attenuated into short apical horn. Ortho, quadra/penta. Cingulum descending 1–1.5×. Sulcus slightly invades epitheca. APC of B' type. Produces cysts.

**Remarks:** Can be confused with *P. oceanicum* which is larger and has longer apical and antapical horn, greater cingulum inclination dorsally, and the left antapical horn is obviously directed ventrally.

**Distribution:** Principally coastal and open water, but found in estuarine environments. Temperate to tropical species; cosmopolitan.

***Protoperidinium conicoides*** (Paulsen) Balech 1973 (not illustrated)

Small biconical cell with indented posterior margin that has two winged antapical spines. Cell circular in cross section. Epitheca and hypotheca

Protoperidinium

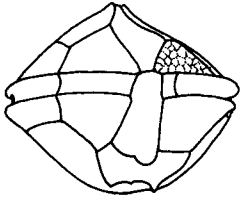

—



*P. subinerme* cyst

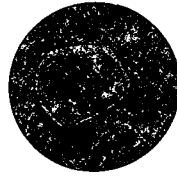

10  $\mu$

*P. punctulatum* cyst

*P. subinerme*

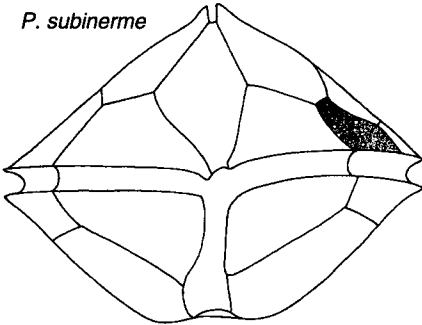

—

*P. punctulatum*

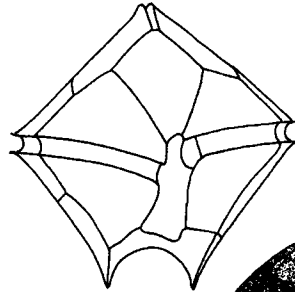

—

*P. leonis*



10  $\mu$

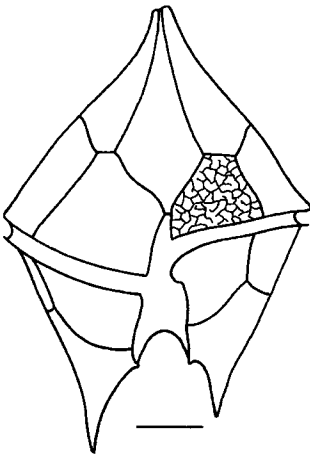

—

*P. claudicans*

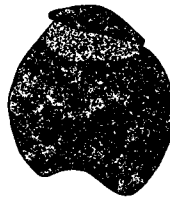

—

*P. claudicans* cyst

PLATE 51 *Protoperidinium subinerme* and cyst, *P. punctulatum* and cyst, *P. leonis* and cyst, and *P. claudicans* and cyst. Scale = 10  $\mu$ m.

with convex sides. Surface lightly reticulate with short spines at junctures of network. Ortho, hexa. Cingulum circular; sulcus slightly invades epitheca. Sulcus excavated to the left right below the cingulum. 1" quadrangular; 7" triangular as in *P. conicum*. APC probably of A' type. Forms cysts.

**Remarks:** Balech (1988a) recognizes a meta form of this species.

**Distribution:** Coastal; temperate. Worldwide.

***Protoperidinium conicum*** (Gran) Balech 1974 (Plate 53)

Medium-sized to large pentagonal cell with short antapical horns. Ventral epitheca concave. Dorsoventrally compressed. Ortho, hexa. Cingulum circular. Surface reticulated. Anterior sutures of 1', right suture of 1", and left suture of 7" are excentuated and form a thick inverted V suture line from the X plate. Broad 1' and triangular 1" and 7". APC of A' type. Forms cysts.

**Remarks:** Distinctive species.

**Distribution:** Coastal and oceanic. Cosmopolitan in temperate to tropical waters.

***Protoperidinium crassipes*** (Kofoid) Balech 1974 (Plate 53)

Large cell with apical and antapical horns; right antapical horn wider and longer than left horn. Cell almost circular in cross section. Ventral area slightly excavated. Surface reticulate. Meta, quadra. Cingulum descending 1 or 2x. APC probably of B' type.

**Remarks:** Not as angular as *P. depressum* or *P. divergens*. Phagotrophic.

**Distribution:** Coastal; even forms blooms in warm water estuaries. Temperate to tropical waters; cosmopolitan.

***Protoperidinium depressum*** (Bailey) Balech 1974 (Plate 52)

Large cell with prominent apical horn and two divergent antapical horns. Epitheca excavated and concave; almost as deep as wide. Surface reticulated. Ortho, quadra. Cingulum descending >2x. APC of B' type.

**Remarks:** Distinctive species. Phagotrophic.

**Distribution:** Coastal and oceanic; even forms blooms in warm water estuaries. Temperate to tropical waters; cosmopolitan.

***Protoperidinium divergens*** (Ehrenberg) Balech 1974 (Plates 6 and 53)

Medium-sized cell with apical and antapical horns. Divergent antapical horns with sulcal lists characteristic for species complex. Epitheca excavated ventrally. Surface reticulated with spines at junctures of network. Meta, quadra. Cingulum almost circular, slightly ascending (to 0.5x). APC of B' type.

**Remarks:** Similar to *P. depressum* but smaller, not as deep, and with a meta 1'.

Protoperidinium

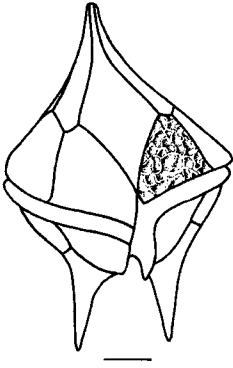

*P. oblongum*

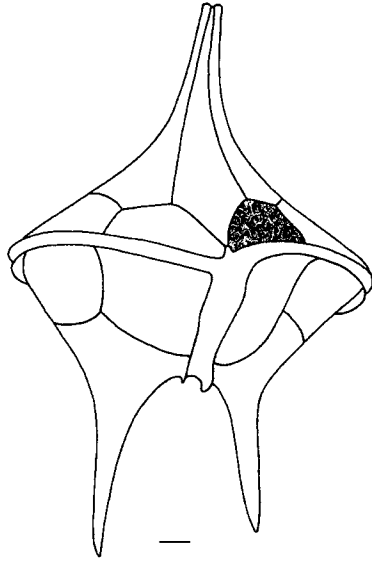

*P. oceanicum*

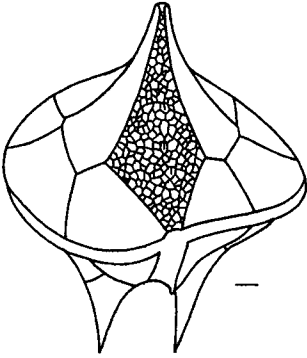

*P. depressum*

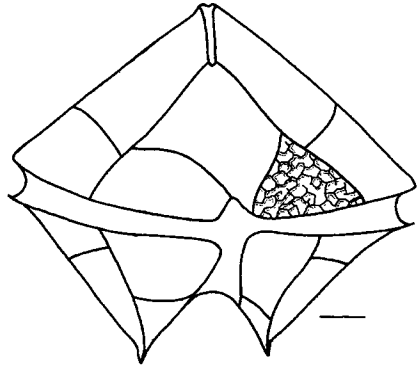

*P. conicum*

PLATE 52 *Protoperidinium oblongum*, *P. oceanicum*, *P. depressum*, and *P. conicum*.  
Scale = 10  $\mu$ m.



**Distribution:** Principally coastal, temperate to tropical waters. Cosmopolitan.

***Protoperidinium elegans*** (Cleve) Balech 1974 (Plate 54)

Large cell with long apical and antapical horns. Cell greatly compressed between base of apical horn and proximal end of antapicals which arise from antapical plates; this central area almost flat. Apical horn centrally located. Antapical horns almost straight, slightly divergent with corrugated ends. Right horn in front of left. Surface reticulated. Meta, quadra. Cingular circular or slightly displaced. APC probably of B' type.

**Remarks:** Can be confused with *P. truncatum* (Graham) Balech. Form *P. elegans* f. *granulata* has more divergent antapical horns and is clearly separable.

**Distribution:** Coastal and oceanic; tropical waters; worldwide.

***Protoperidinium excentricum*** (Paulsen) Balech 1974 (not illustrated)

Small to medium-sized cell; anterioposteriorly compressed with the apical horn offset to the left and ventral. Epitheca concave dorsally, hypotheca concave ventrally. In dorsal view, apex-antapex axis is oblique. Sulcus deeply notches antapex; left sulcal area, with list, more prominent. Ortho. Two asymmetrical anterior intercalaries; 2a extremely large. Cingulum circular or slightly ascending. APC of B' type.

**Remarks:** Distinctive species.

**Distribution:** Primarily estuarine and coastal. Temperate to tropical waters; cosmopolitan.

***Protoperidinium fatulipes*** (Kofoid) Balech 1974 (Plate 54)

Large cell with long apical and antapical horns that are connected by a bridge. Cell shape similar to *P. elegans* but the central region above and below cingulum not as compressed. Surface reticulated. Meta, quadra.

Cingulum circular to slightly descending. APC probably of B' type.

**Distribution:** Tropical waters; worldwide distribution.

***Protoperidinium grande*** (Kofoid) Balech 1974 (Plate 54)

Large cell similar to *P. divergens* but with longer apical and antapical horns. Antapical horns broad proximally and pointed distally. Cell body flattened in midregion with ventral left edge of cingulum straight and not curved. Meta, quadra. Cingulum circular to slightly descending. APC of B' type.

**Distribution:** Oceanic; warm temperate to tropical waters; worldwide distribution.

***Protoperidinium leonis*** (Pavillard) Balech 1974 (Plate 51)

Medium-sized pentagonal or rhombic-shaped species with indented posterior margin with two short antapical spines. Cell as long as wide or

slightly longer. Ventral epithelial surface excavated or slightly concave. Epitheca in outline with straight or slightly convex edges. Surface with broad-based spines that can coalesce. Ortho, hexa. Cingulum descending 1–1.5x. 1' characteristic with anterior portion shorter than posterior; 1'' and 7'' quadrangular. APC of A' type. Forms cysts.

**Remarks:** Can be easily confused with *P. obtusum*.

**Distribution:** Coastal and oceanic; temperate to tropical waters; worldwide distribution.

***Protoperidinium minutum*** (Kofoid) Loeblich III 1970 (not illustrated)

Small globular cell with short apical horn. Sulcus expands posteriorly and has prominent, short left sulcal list. Surface with papillae or short spines.

Ortho, hexa. Cingulum circular. Only two anterior intercalaries. Produces cysts.

**Distribution:** Coastal and open water. Cold temperate to warm waters; cosmopolitan.

***Protoperidinium nudum*** (Meunier) Balech 1974 (not illustrated)

Small globular cell, as long as wide. Posterior margin slightly indented with two very short antapical spines formed from sulcal lists. Hypothecal surface markings or faint reticulae with short spines at junctures in network. Ortho, hexa. Cingulum circular; sulcus does not invade epitheca.

**Distribution:** Coastal and open water; cold temperate waters; Atlantic Ocean.

***Protoperidinium oblongum*** (Aurivillius) Parke & Dodge 1976 (Plate 52)

Medium-sized species. Attenuated pyriform shape with apical and antapical horns. Ventrodorsally compressed with 30–60° inclined cingulum. Ortho, quadra. Cingulum descending 1x. APC of B' type. Produces cysts.

**Remarks:** This species can easily be confused with *P. oceanicum*, *P. claudicans*, and *P. steidingerae*. *Protoperidinium oceanicum* is much larger, while *P. claudicans* is smaller and not as ventrodorsally compressed as *P. oblongum* and *P. oceanicum*. Also, *P. claudicans* is easily distorted with the confinement of a coverslip and usually rounds out even though it is armored. *Protoperidinium steidingerae* lacks the characteristic pore plate complex of all other *Protoperidinium*. This species is often considered a variety or a variant of *P. oceanicum*, and, according to Abé, 1991; the size difference is not applicable.

**Distribution:** Neritic, oceanic; cosmopolitan in cold temperate to tropical waters.

***Protoperidinium obtusum*** (Karsten) Parke & Dodge 1976 (not illustrated)

Medium-sized species similar to *P. leonis* with descending cingulum, 1x;

shorter anterior margins to 1', and characteristic longitudinal striae on epitheca. Cell wider than long. Striae appear to be formed between rows of pores as in some *Gonyaulax*. APC of A' type.

**Remarks:** This species is often identified as *P. leonis*.

**Distribution:** Coastal and oceanic; temperate to tropical. Cosmopolitan.

***Protoperidinium oceanicum*** (VanHöffen) Balech 1974 (Plate 52)

**Synonym:** *P. murrayii* Kofoid 1907.

Large cell similar in shape to *P. oblongum* but with longer, narrower divergent antapical horns. Ortho, quadra. Cingulum descending 1–1.5×. Cingulum inclined 30–60°, placed high on dorsal side.

**Remarks:** See *P. oblongum*.

**Distribution:** Coastal and oceanic; temperate to tropical waters. Cosmopolitan. Uncommon in cold temperate waters.

***Protoperidinium pallidum*** (Ostenfeld) Balech 1973 (Plate 54)

Medium-sized elongate pyriform cell with two divergent antapical spines and a short apical horn. Dorsoventrally compressed. Surface reticulated. Para, hexa. Cingulum ascending 1×. APC of B' type.

**Remarks:** Similar to *P. tristylum* and *P. schilleri*, but often confused with *P. pellucidum*. *Protoperidinium pallidum* has been reported to have chloroplasts by F. J. R. Taylor (1976).

**Distribution:** Coastal and oceanic from cold temperate to warm temperate waters; worldwide distribution.

***Protoperidinium parthenopes*** Zingone & Montresor 1988 (Plate 53)

Small biconical cell; circular in cross section. Surface with raised pores and faint reticulae. Ortho, penta. Cingulum median and slightly ascending, 0.5×. Sulcus extends to antapex. 1' asymmetrical and shifted to right with triangular 7" and quadrangular 1". 1c not transitional as in most other *Protoperidinium*.

**Remarks:** Similar to *P. americanum* which has 4a, an unusual hexa 2a, and a five-sided 3'. The shape of the 3' probably determines whether there are 4a or 3a, e.g., if it is five-sided there could be 4a, if triangular, then 3a.

**Distribution:** Recently described species from the Gulf of Naples, Italy.

***Protoperidinium pellucidum*** Bergh 1881 (Plate 54)

Small to medium-sized broadly pyriform cell with short apical horn, two winged antapical spines, and one prominent curved, antapical winged spine that originates from a left sulcal list. Circular in cross section. Surface reticulated. Para, hexa. Cingulum slightly ascending, 0.5×. APC of B' type.

**Remarks:** Although this species can be confused with *P. pallidum*, it is smaller, circular in cross section, and has a prominent sulcal list that ends in a curved antapical spine.

Protoperidinium

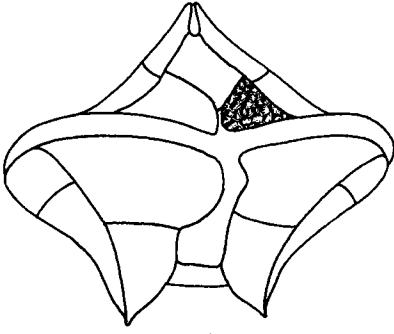

*P. pentagonum*

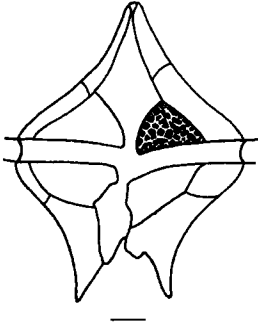

*P. divergens*

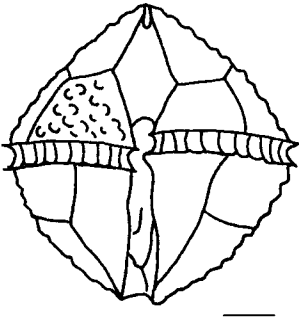

*P. thorianum*

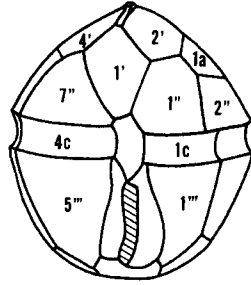

*P. parthenopes*

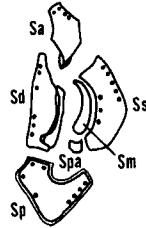

*P. parthenopes*

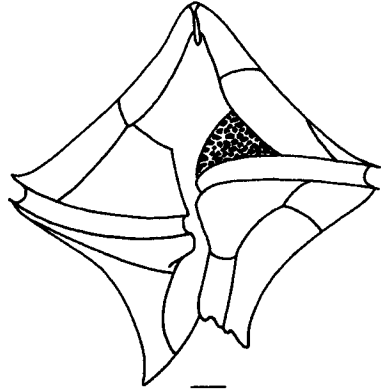

*P. crassipes*

PLATE 53 *Protoperidinium pentagonum*; *P. parthenopes* and sulcal plates redrawn from Zin-gone & Montresor (1988); *P. divergens*; *P. thorianum* redrawn from Lebour (1925); *P. crassipes*. Scale = 10  $\mu$ m.

Protoperidinium

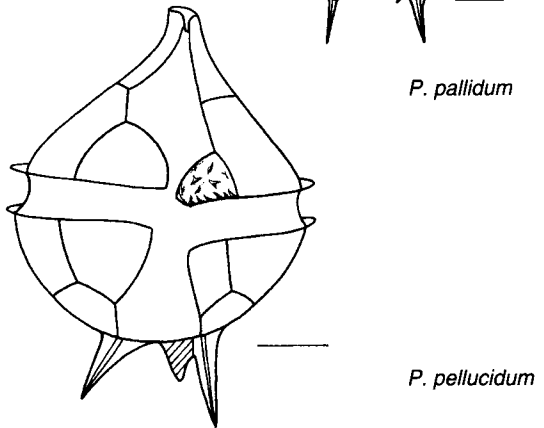
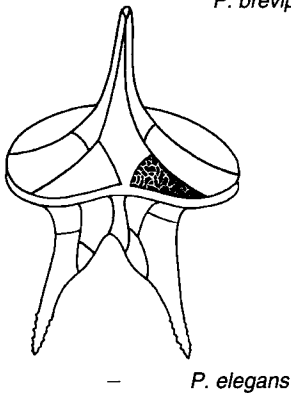
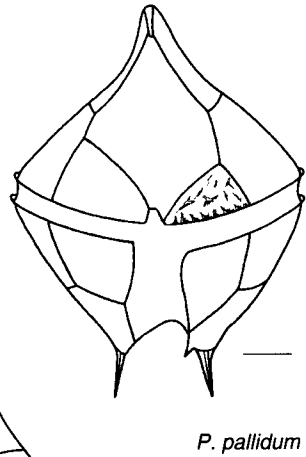
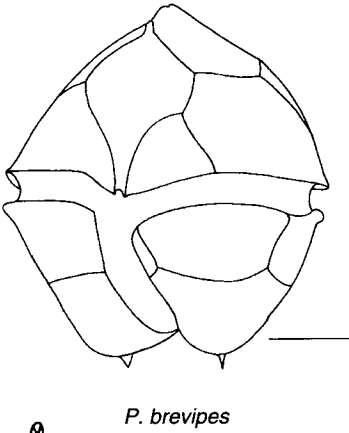
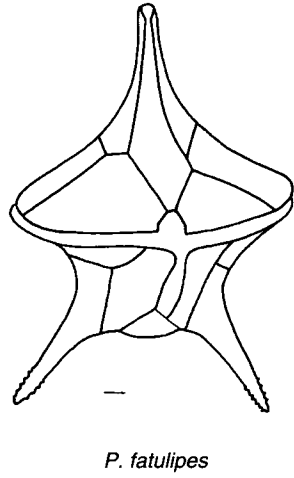
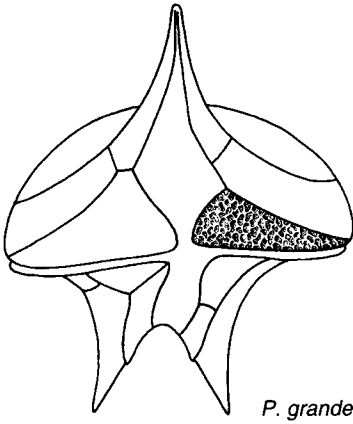

PLATE 54 *Protoperidinium grande*, *P. fatulipes*, *P. brevipes*, *P. pallidum*, *P. elegans*, and *P. pellucidum*. Scale = 10  $\mu$ m.

**Distribution:** Mainly coastal and cosmopolitan in temperate to tropical waters.

***Protoperidinium pentagonum*** (Gran) Balech 1974 (Plate 52)

Medium-sized to large, broadly pentagonal cell with truncate posterior margin with short antapical winged spines. Sulcus broad posteriorly, not extending to antapex. Cell in cross section reniform. Ortho, penta/hexa. Cingulum descending 1 or 2 $\times$ . APC of A' type. Ventral view of 1' and 1'' and 7'' similar to *P. conicum*. Produces cysts.

**Remarks:** Distinctive species; can be confused with *P. latissimum* which was originally classified as a variety of this species. *Protoperidinium latissimum* is a broader cell with the epitheca often appearing as an angled roof overhanging the hypotheca; cell in cross section more reniform with the right side wider than the left; sulcus J shaped; and cingulum often convoluted. Wall & Dale (1968) reported a para 1' rather than ortho.

**Distribution:** Principally coastal, but found in estuarine environments. Cosmopolitan in temperate to tropical waters.

***Protoperidinium quarnerense*** (Schröder) Balech 1974 (not illustrated)

Medium-sized subglobulose cell with button-like APC and two antapical spines. Surface with pores. Meta, quadra/penta. Cingulum ascending, 1–1.5 $\times$ , with overhang. Sulcus invades epitheca; sa touches 1' as in other armored species.

**Remarks:** This species was once considered a variety of *P. globulus*.

**Distribution:** Principally oceanic; cosmopolitan in warm temperate to tropical waters.

***Protoperidinium subinerme*** (Paulsen) Loeblich III 1970 (Plate 51)

Medium-sized pentagonal cell with indented posterior margin. Cell almost circular in cross section. Sulcus broader posteriorly, sometimes L shaped because of the wide sp plate. Ortho, hexa. Cingulum circular. Surface reticulate with short spines at junctures of network. Anterior sutures of 1' shorter than posterior and straight or concave in outline. Posterior sutures of 1' can be slightly convex in outline making posterior half of 1' wider. APC of A' type.

**Remarks:** Can be confused with *Peridinium punctulatum* (Paulsen) Balech (Plate 51) which was once considered a variety of this species. *Peridinium punctulatum* is more broadly pentagonal with a rounded, truncate antapex; surface markings are papillae or broad-based short spines; ventral area is more excavated; 2a typically penta but can be hexa; sulcus extends to antapex and is not expanded posteriorly.

**Distribution:** Coastal and open water. Temperate to tropical waters. Cosmopolitan.

***Protoperidinium thorianum*** (Paulsen) Balech 1974 (Plate 53)

Medium-sized cell; almost broadly biconical with slightly indented posterior margin. Circular in cross section. Hypotheca exceeds epitheca in length. Sulcus deeply excavated, widening and extending to posterior margin. Surface rugose with pits with raised edges; sometimes reported as papillae. Ortho, hexa. Only two anterior intercalaries; approximately the same size and shape. Cingulum descending about 1×. Produces cysts.

**Remarks:** Distinctive species but can be confused with *P. avellana* which does not have a rugose cell surface and has a narrower sulcus and a median cingulum.

**Distribution:** Coastal and open water. Cold temperate to warm water; cosmopolitan.

**Family Thecadiniaecae** Balech 1956

**Genus *Amphidiniopsis*** Woloszyńska 1929 (<5 spp.)

**Synonym:** *Thecadinium* Balech in part.

**Type:** *A. kofoidii* Woloszyńska 1929.

**References:** Dodge, 1982; Saunders & Dodge, 1984; Dodge & Lewis, 1986.

Armored. Small dorsoventrally flattened cell with reduced epitheca.

Cingulum–sulcus juncture Y shaped. Sulcus extends to the antapex. Plate formula: Po, 4', 1–3a, 5 or 6", 3c?, ?s, 5"', and 2'''. Plates typically have ornamentation. Chloroplasts present or absent.

***Amphidiniopsis kofoidii*** Woloszyńska 1929 (not illustrated)

Not to be confused with *Thecadinium kofoidii*. Epitheca with rounded apex and characteristic curved beak protuberance that creates a central “notch.” Rounded or bilobed hypotheca with sulcus broadening toward antapex. Sulcus with central flange/list. Six precingulars and three anterior intercalaries. Thick plates have linear rows of pores or markings.

Chloroplasts absent.

**Distribution:** Benthic, sand dweller, sometimes tychoplanktonic; temperate waters.

**Genus *Roscoffia*** Balech 1956 (<5 spp.)

**Type:** *R. capitata* Balech 1956.

**References:** Balech, 1956; Dodge, 1982.

Armored. Small ovoid cell with premedian, deep cingulum. Epitheca cap shaped. Plate formula: Po?, 4', 5'', 3c, 3s, 5''', 1''''.

***Roscoffia capitata*** Balech 1956

Thecal plates reticulated.

**Distribution:** Benthic, sand dweller; temperate waters. Sometimes tychoplanktonic.

**Genus *Thecadinium*** Kofoid & Skogsberg 1928 (>5 spp.)

**Synonym:** *Phalacroma* Stein 1883 in part.

**Type:** *T. kofoidii* (Herdman) Schiller 1933.

**References:** Kofoid & Skogsberg, 1928; Dodge, 1982; Saunders & Dodge, 1984; Faust & Balech, 1993.

Armored. Small, laterally flattened cell with reduced epitheca. Cingulum premedian and sulcus extends to antapex. Can look like *Amphidinium*, but with plates. Plate formula: Po, 3', 1a, 4'', 5c?, 5s, 3''', and 1''''.

Reported with or without chloroplasts.

***Thecadinium kofoidii*** (Herdman) Schiller 1933 (Plate 55)

**Synonym:** *T. petasatum* Dodge 1982

Epitheca triangular in ventral view and a rounded hypotheca in lateral view. Chloroplasts present.

**Distribution:** Benthic, sand dweller; temperate to tropical waters.

**Order Thoracosphaerales** Tangen in Tangen et al., 1982

**References:** Tangen et al., 1982; Inouye & Pienaar, 1983; Sournia, 1986; Fensome et al., 1993.

Dominant stage with a calcareous wall; motile stage unarmored and gymnodinioid. Calcareous stage can undergo nuclear division releasing a binucleate single unarmored cell through an opening in the wall that then can divide to produce biflagellated gymnodinioid cells which round out and become immature coccoid stages.

**Remarks:** This order has some affinities with the family Calciodinellaceae in the Peridinales because of a calcareous-walled stage and archeopyle-like opening. Sournia (1986) placed it in the Dinococcales.

**Family Thoracosphaeraceae** Schiller 1930

**Genus *Thoracosphaera*** Kamptner 1927 (<5 spp.)

**Type:** *T. heimii* (Lohmann) Kamptner 1944.

**References:** Tangen et al., 1982; Inouye & Pineaar, 1983; Sournia, 1986; Fensome et al., 1993.

No armored stages known. Gymnodinioid dinospores produced.

Chloroplasts present.

**Remarks:** This type species was previously thought to be a coccolithophorid.



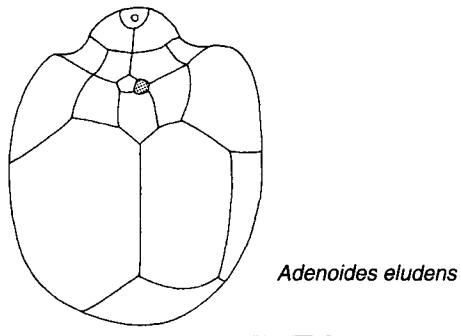
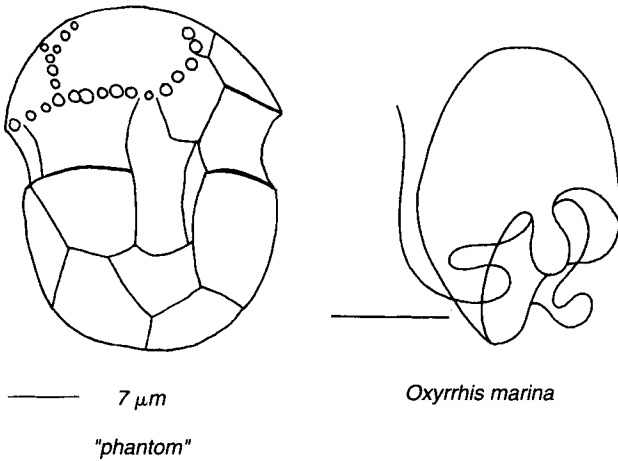
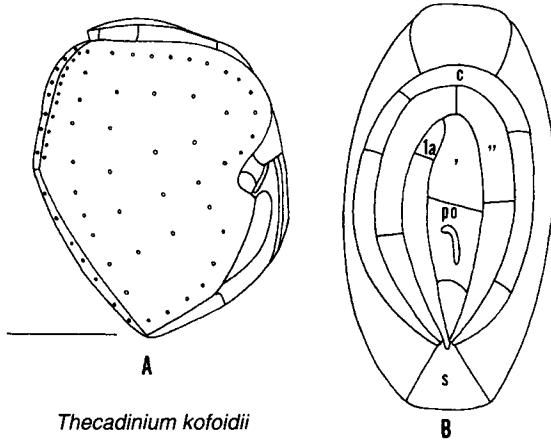

**PLATE 55** Scale =  $10 \mu\text{m}$  unless otherwise indicated. *Thecadinium kofoidii*; (A) lateral view and (B) apical view redrawn from Saunders & Dodge (1984); phantom (scale =  $7 \mu\text{m}$ ), *Oxyrrhis marina* redrawn from Dodge (1982); and *Adenoides eludens* redrawn from Dodge & Lewis (1986).

*Thoracosphaera heimii* (Lohmann) Kamptner 1944 (not illustrated)

**Distribution:** Oceanic. Widely distributed in temperate and warm waters.

**Order Blastodinales** Schiller 1935

**References:** Chatton, 1952; Loeblich III, 1982; Cachon & Cachon, 1987; Fensome et al., 1993; Landsberg et al., 1994.

External parasites on fishes and invertebrates.

Invertebrate hosts include copepods, appendicularians, siphonophores, polychaetes, pteropods, and coelenterates. Armored and unarmored dinospores known.

**Order Syndiniales** Loeblich III 1976

**References:** Loeblich III, 1982; Sournia, 1986; Cachon & Cachon, 1987; Fensome et al., 1993.

Internal parasite of dinoflagellates, invertebrates, and fish eggs. The trophont stage is multinucleate and the biflagellated infective stage is uninucleate.

**Remarks:** The genus *Amoebophrya* Koeppen 1894 parasitizes free-living dinoflagellates and the intracellular mature trophont stage appears as a “bee hive” or spiral rings. It can occupy almost the entire cytoplasm.

**Order Phytodinales** Loeblich III 1970

**References:** Loeblich III, 1982; Popovsky & Pfister, 1990; Fensome et al., 1993.

Mostly freshwater. Dominant stage nonmotile and attached by a stalk, disk, or predetermined area of the cell. Produces unarmored gymnodinioid zoospores or armored zoospores with a Kofoidian plate tabulation. Chloroplasts present.

**Family Phytodiniaceae** Klebs 1912

**Genus** *Spiniferodinium* Horiguchi & Chihara 1987

**Type:** *S. galeiforme* Horiguchi & Chihara 1987

**Reference:** Horiguchi & Chihara (1987)

Unicell with nonmotile dominant stage, attached to substrate or immobile, and with rigid, spiny helmet-shaped covering. Contains dinokaryotic nucleus and chloroplasts. Reproduction by gymnodinioid zoospores that are dorsoventrally flattened with a median, circular cingulum.

*Spiniferodinium galeiforme* Horiguchi & Chihara 1987 (not illustrated)

Nonmotile phase with cingulum but without flagella, encapsulated by outer shell with spines and mucous. Unarmored small, biflagellated phase without spines and with a circular, median cingulum and a sulcus that notches the hypotheca and invades the epitheca.

**Distribution:** Recently described benthic and attached species with known distribution limited to the subtropical beach areas Okinawa Prefecture, Japan.

**Order Dinotrichales** Pascher 1914

**References:** Loeblich III, 1982; Fensome et al., 1993.

Dinoflagellates with a biphasic life cycle—an immobile, filamentous, benthic, or epiphytic stage and a planktonic gymnodinioid stage.

**Order Dinamoebiales** Loeblich III 1970

**References:** Loeblich III, 1982; Burkholder et al., 1992, 1994; Fensome et al., 1993; Landsberg et al., 1995; Steidinger et al., 1995.

Multiphasic life cycle with unicellular stages representing planktonic bi- and triflagellated motile forms of a gymnodinioid or peridinioid type.

Benthic or temporarily amoeboid forms with filapodia or lobopodia, and benthic cyst stages of multiple forms. Heterotrophic nutrition.

**Remarks:** This group is often placed in the Phytodinales because the dominant stage is assumed to be coccoid; the amoeboid stage typically occurs between two other stages and is released through an opening. In this order, the amoeboid stage can be a direct transformation of the flagellated stage.

**Distribution:** A new species (Plate 55) of this group was discovered in southeastern U.S. estuarine waters and called the “phantom” dinoflagellate or ambush predator. It produces an exotoxin and causes fish kills; it is nonphotosynthetic and is thinly armored with a Kofoidian plate tabulation. It is often mistaken as a gymnodinioid. Positive identification requires scanning electron microscopy.

## UNCERTAIN TAXA

**Genus *Adenoides*** Balech 1956 (<5 spp.)

**Type:** *A. eludens* (Herdman) Balech 1956.

**References:** Balech, 1956; Dodge, 1982; Dodge & Lewis, 1986.

Armored. Small, slightly laterally flattened cell with premedian cingulum and cap-like epitheca. Looks like laterally flattened *Amphidinium* with a short sulcus, but has delicate theca with the plate formula: Po, 3', 5', 5c, 6s, 4''', 5p (4p), and 1'''(2'''). Theca with scattered pores. Pore plate without pore. Chloroplasts present.

***Adenoides eludens*** (Herdman) Balech 1956 (Plate 55)

Nearly symmetrical with narrow left sulcal list. Plates 3 and 4p both with one large pore, otherwise no thecal ornamentation.

**Distribution:** Benthic, sand dweller; temperate waters. Sometimes tycho planktonic.

**Genus** *Oxyrrhis* Dujardin 1841 (<5 spp.)

**Type:** *O. marina* Dujardin 1841.

**References:** Dodge & Crawford, 1971; Jianfan & Jingyan, 1992; Loeblich III, 1984; Sournia, 1986; Fensome et al., 1993.

Unarmored. Small ovoid cell; slightly compressed laterally without cingulum and sulcus. Posterior portion of cell with a tentacular lobe and a dorsal flap; two dissimilar flagella (one with fine hairs) arise posteriorly.

Scales cover the cell and flagella. Chloroplasts absent; heterotrophic.

**Remarks:** The question of whether *Oxyrrhis* is a dinoflagellate still remains, particularly with the evidence of a nonconforming morphology, different cortical microtubular cytoskeleton, different flagella, and a different nuclear structure. *Oxyrrhis* appears to be in between dinoflagellates and other eukaryotes.

*Oxyrrhis marina* Dujardin 1841 (Plate 55)

**Remarks:** Distinctive species.

**Distribution:** Marine and brackish inshore waters, coastal rock pools, estuaries, and marshes. Temperate to tropical; cosmopolitan.

**Genus** *Pleromonas* Pascher 1914 (1 sp.)

**Type:** *P. erosa* Pascher 1914.

**References:** Schiller, 1933; Sournia, 1986; Fensome et al., 1993.

Unarmored but cellulosic thin cell wall. Small, ovoid cells with two apically inserted similar flagella that beat perpendicular to one another.

Anterior end truncate with vacuole. Nucleus typically dinokaryotic; chloroplast(s) present with central pyrenoid.

**Remarks:** Pascher observed cells dividing within the parent wall similar to the longitudinal division of *Prorocentrum* and although free single cells were not observed to have two opposing valves, this monotypic genus may represent very thinly valvate *Prorocentrum* under resting or stress conditions.

*Pleromonas erosa* Pascher 1914 (not illustrated)

**Distribution:** Originally, description based on occurrence in an aquarium of marine algae.

## TECHNIQUES FOR PREPARATION OF DINOFLAGELLATES FOR IDENTIFICATION

---

### Cell Immobilization and Fixation

There are advantages and disadvantages to using live or dead specimens for observation. Live cells, either field or cultured specimens, provide information on pigmentation, swimming behavior, cytology and location of organelles, reproductive stages, cell orientation, size and shape, and other features. There

are several techniques to immobilize live dinoflagellates to observe their external and internal characters: (1) glass slides (3 x 1 in.) with a drop of material can be put in the refrigerator at 4°C without a coverslip for about 3 min; longer exposure will typically lyse cells. It is important to remember that whole samples from warm temperate and tropical waters should not be refrigerated or iced, either in transport or storage, because many cells are fragile and will lyse. It is preferable to store the samples at ambient temperature or to wrap wet towels or newspaper around the sample container so that evaporation keeps the sample cool. These samples can be kept in the dark or low light for 24 to 48 hr; however, if you are doing enumerations, there will be species composition and abundance changes with storage. (2) One milliliter of 4% saturated uranyl acetate (UA) added to 1 liter of sample will typically slow down motile cells, or the UA can be added to the edge of a coverslip. (3) Methyl cellulose or MS-222 (a chemical relaxant) can also be added to samples to immobilize dinoflagellate cells. Another method is to prepare a microscopic slide with sample and a coverslip and wait for the heat of the microscope lamp to slow the movement of cells. Cells typically cast off their flagellar first and unarmored species then round up and lyse; armored cells usually remain intact or shed their theca (ecdysis). Many unarmored dinoflagellate species do not fix and preserve well with standard fixatives such as Lugol's solution and formalin; however, they do fix well with buffered glutaraldehyde (2% GTA with sodium cacodylate or borate/borax), a combined buffered glutaraldehyde/osmium tetroxide cold fix (GTA/OsO<sub>4</sub>) (Steidinger et al., 1989; Landsberg et al., 1994; 1 or 2% OsO<sub>4</sub>, or even a weak formalin solution (0.5–1%). For scanning electron microscopy of unarmored and lightly armored cells, the combined, buffered GTA/OsO<sub>4</sub> is the best fixative, followed by critical-point drying, and coating with gold/palladium (Steidinger et al., 1995).

Armored species are more resistant and most cells fix and preserve well in 1–4% formalin or Lugol's. Lugol's solution tends to stain the protoplasm of dinoflagellates to the point that observing surface ornamentation and plates may be difficult. A few drops of sodium thiosulfate (0.1–1 N) can be used to destain specimens. In scanning electron microscopy, the outer membrane of armored cells can obscure plates and plate patterns; therefore, it is sometimes necessary to remove the outer membrane by using a pretreatment of 40% ethanol (M. Montresor, personal communication). Also, armored dinoflagellates, such as *Dinophysis*, *Ceratium*, *Ornithocercus*, and others with heavy armor, can be prepared for SEM by fixation in formalin, mounting individual cells on an SEM stub, rinsing the stub with distilled water 10–20 times under a dissecting microscope to ensure that specimens are not washed away and that a salt ring does not develop at the periphery of the stub, air drying, and coating with gold/palladium.

#### Temporary and Permanent Slide Mounts

Temporary and permanent slide mounts for preserved armored species can be made using several simple techniques. Temporary wet mounts can be made

using Vaseline or stopcock grease to seal the edges of the coverslip and this provides a movable mount if you want to reorient the cell under study. Using nail polish as a sealant provides a slightly moveable mount. If you are using an inverted microscope, depression slides with drops of sample can be maintained without a coverslip in a closed petri dish that has a piece of moist sponge or wet toweling. This technique is also suitable for observing and photographing sequential stages in sexual reproduction, e.g., formation of gametes and zygotes, or for observing larger specimens that are often squashed by a coverslip. For larger specimens, raised wet mounts, such as with Vaseline or slivers of coverslip, can also be used to observe cells. Several permanent mounting media are commercially available, e.g., Permount, and these slide mounts can be sealed with nail polish or a commercial sealant. However, typically with these media, you first have to rinse the sample preparation in deionized or distilled water to remove the salt and then you have to go through several dehydration steps to remove the water before you can use the mounting medium. An alternative mounting medium offers the advantage of not having to do freshwater rinses and dehydration steps; a drop of sample can be mixed with a glycerin jelly preparation. Glycerin jelly is prepared by dissolving 10 g of gelatin in 60 ml of deionized water to which 70 ml of glycerin (glycerol) is added and 1 g of thymol dissolved as a preservative. Stir the mixture carefully to avoid developing bubbles. Specimens are placed on a clean slide with one or two drops of glycerin/jelly mounting medium and covered with a coverslip to dry on a slide warmer at 55°C for 6 hr. Once sealed, these mounts can last >13 years. Permanent mounts in which specimens are fixed in one view (cells cannot be rotated and plates cannot be separated) are not as valuable as preserved specimens kept in sealed vials as wet stack material, providing the material is maintained, e.g., topped up. Photo- and electron micrographs, representing different views, are also valuable reference and voucher material, providing they are cataloged and annotated.

### **Microscopic Techniques**

Brightfield microscopy of armored dinoflagellates often requires chemical staining to observe plate sutures and plate patterns. Trypan blue (0.2–0.3%) or von Stosch's (1969) HI/I<sub>2</sub>/chloral hydrate technique are useful chemical stains. Phase contrast and differential contrast microscopy offer optical "staining" that is often superior to any chemical stain for observing organelles, surface ornamentation, and plate patterns. In armored dinoflagellates, plates can be separated using sodium hypochlorite (5%) applied to the edge of the coverslip, but continual observation of individual specimens is required to accurately determine the position of plates that quickly separate from the protoplasm. Graham's (1942) glycerin jelly technique can help reduce the movement of separating plates and maintain them in close proximity to one another. Gentle pressure applied to the coverslip (e.g., with a toothpick or small

probe) over the specimen can cause the theca to rupture and the protoplasm to extrude. Freeing the theca from the rest of the cell is the best, and sometimes only, way to identify some armored species because it allows detection of plates without the background interference from pigments obscuring plate sutures. This squash technique is accomplished by first pulling off as much water as possible from under the coverslip using a tissue pressed to one side that will absorb the liquid by capillary action. Then apply physical pressure with the toothpick and gently move the coverslip back and forth to dissociate plates. If using hypochlorite, add it to the edge of the coverslip after draining the excess liquid. Another technique involves fluorescence microscopy for detecting surface markings and plate sutures in armored cells (Fritz & Triemer, 1985). It uses a fluorochrome called Calcofluor White M2R that binds to plate material, such as cellulose, and reveals plate sutures and pores in thinly thecate cells as well as heavily armored cells. This technique is applicable for cells about 20  $\mu\text{m}$  and above. In some species, this technique removes the necessity to separate plates with hypochlorite in order to detect them.

Steidinger (1979) summarized several collection, enumeration, and identification techniques for free-living marine dinoflagellates. Other useful technique papers include Graham (1942; a glycerin jelly technique for studying separated plates and whole armored cells), Burrells (1977; microscopy), Needham (1977; microscopy), Sournia (1978; all techniques), Dale (1979; dinoflagellate cysts), Loper et al. (1980; chromosome squashes), Postek et al. (1980; SEM techniques), Berland (1982; image reversal in microscopy), Pfiester & Holt (1982; chromosome squashes), Guillard & Keller (1984; culturing), Dodge (1985), Matsuoka et al. (1989; dinoflagellate cyst techniques), and Throndsen (1993; flagellates).

## COMMON DINOFLAGELLATE SYNONYMS

---

*Actiniscus pentasterias* (Ehrenberg) Ehrenberg

= *Dictyocha pentasterias* Ehrenberg

= *Gymnaster pentasterias* Schütt

*Alexandrium acatenella* (Whedon & Kofoid) Balech

= *Gonyaulax acatenella* Whedon & Kofoid

= *Gessnerium acatenellum* (Whedon & Kofoid) L. Loeblich & Loeblich III

= *Protogonyaulax acatenella* (Whedon & Kofoid) Taylor

*Alexandrium catenella* (Whedon & Kofoid) Balech

= *Gonyaulax catenella* Whedon & Kofoid

*Alexandrium affine* (Inoue & Fukuyo) Balech

= *Protogonyaulax affinis* Inoue & Fukuyo

= *Alexandrium fukuyoi* Balech

- Alexandrium balechii* (Steidinger) Balech  
= *Pyrodinium balechii* (Steidinger) Taylor  
= *Gonyaulax balechii* Steidinger
- Alexandrium cohorticula* (Balech) Balech  
= *Protogonyaulax cohorticula* (Balech) Taylor  
= *Gessnerium cohorticula* (Balech) L. Loeblich & Loeblich III  
= *Gonyaulax cohorticula* Balech
- Alexandrium compressum* (Fukuyo, Yoshida, & Inoue) Balech  
= *Protogonyaulax compressa* Fukuyo, Yoshida, & Inoue  
= *Protogonyaulax* sp. Fukuyo
- Alexandrium concavum* (Gaarder) Balech  
= *Gonyaulax concava* (Gaarder) Balech  
= *Goniodoma concavum* Gaarder
- Alexandrium fraterculus* (Balech) Balech  
= *Gessnerium fraterculum* (Balech) L. Loeblich & Loeblich III  
= *Protogonyaulax fratercula* (Balech) Taylor  
= *Gonyaulax fratercula* Balech
- Alexandrium kutnerae* (Balech) Balech  
= *Gonyaulax kutnerae* Balech
- Alexandrium monilatum* (Howell) Balech  
= *Pyrodinium monilatum* (Howell) Taylor  
= *Gonyaulax monilatum* (Howell) Loeblich III  
= *Gessnerium mochimaensis* Halim  
= *Gonyaulax monilata* Howell
- Alexandrium minutum* Halim  
= *Alexandrium ibericum* Balech  
= *Pyrodinium minutum* (Halim) Taylor
- Alexandrium ostenfeldii* (Paulsen) Balech & Tangen  
= *Triadinium ostenfeldii* (Paulsen) Dodge  
= *Gessnerium ostenfeldii* (Paulsen) L. Loeblich and Loeblich III  
= *Protogonyaulax globosa* (Braarud) Taylor  
= *Gonyaulax trygvei* Parke  
= *Gonyaulax globosa* (Braarud) Balech  
= *Heteraulacus ostenfeldii* (Paulsen) Loeblich III  
= *Goniaulax ostenfeldii* (Paulsen) Paulsen  
= *Goniaulax tamarensis* Lebour var. *globosa* Braarud  
= *Pyrodinium phoneus* Woloszynska & Conrad  
= *Goniodoma ostenfeldii* Paulsen
- Alexandrium peruvianum* (Balech & Mendiola) Balech & Tangen  
= *Gonyaulax peruviana* Balech & Mendiola



- Alexandrium pseudogoniaulax* (Biecheler) Horiguchi  
 = *Goniodoma pseudogoniaulax* Biecheler
- Alexandrium tamarense* (Lebour) Balech  
 = ?*Alexandrium excavatum* (Braarud) Balech and Tangen  
 = *Protogonyaulax tamarensis* (Lebour) Taylor  
 = *Gessnerium tamarensis* (Lebour) Loeblich III and L. Loeblich  
 = *Gonyaulax tamarensis* var. *excavata* Braarud  
 = *Gonyaulax tamarensis* Lebour
- Amphidinium operculatum* Claperède & Lachmann  
 = *Amphidinium klebsii* Kofoid & Swezy
- Amphidoma nucula* Stein  
 = *Gonyaulax rouchii* Rampi  
 = *Amphidoma spinosa* (Kofoid) Kofoid & Michener  
 = *Murrayella spinosa* Kofoid
- Amylax triacantha* (Jørgensen) Sournia  
 = *Gonyaulax triacantha* Jørgensen
- Balechina coerulea* (Dogiel) F. J. R. Taylor  
 = *Gymnodinium coeruleum* Dogiel
- Blepharocysta splendor-maris* (Ehrenberg) Stein  
 = *Peridinium splendor-maris* Ehrenberg
- Heterocapsa niei* (Loeblich III) Morrill & Loeblich III  
 = *Cachonina niei* Loeblich III
- Ceratium arcticum* (Ehrenberg) Cleve  
 = *Peridinium arcticum* Ehrenberg
- Ceratium arietinum* Cleve  
 = *Ceratium bucephalum* Cleve
- Ceratium candelabrum* (Ehrenberg) Stein  
 = *Peridinium candelabrum* Ehrenberg
- Ceratium declinatum* (Karsten) Jørgensen  
 = *Ceratium tripos declinatum* Karsten
- Ceratium furca* (Ehrenberg) Claparède & Lachmann  
 = *Peridinium furca* Ehrenberg
- Ceratium fusus* (Ehrenberg) Dujardin  
 = *Peridinium fusus* Ehrenberg
- Ceratium hexacanthum* Gourret  
 = *Ceratium reticulatum* (Pouchet) Cleve  
 = *Ceratium tripos* var. *reticulata* Pouchet
- Ceratium hircus* Schröder  
 = *Ceratium furca* var. *hircus* (Schröder) Margalef

- Ceratium hirundinella* (O. F. Müller) Bergh  
 = *Bursaria hirundinella* O. F. Müller  
*Ceratium horridum* (Cleve) Gran  
 = *Ceratium tripos* var. *horridum* Cleve  
*Ceratium incisum* (Karsten) Jörgensen  
 = *Ceratium furca incisum* Karsten  
*Ceratium inflatum* (Kofoid) Jörgensen  
 = *Ceratium pennatum* var. *inflata* Kofoid  
*Ceratium lineatum* (Ehrenberg) Cleve  
 = *Peridinium lineatum* Ehrenberg  
*Ceratium longipes* (Bailey) Gran  
 = *Ceratium articum* var. *longipes* (Bailey) Graham & Bronikovsky  
 = *Peridinium longipes* Bailey  
*Ceratium lunula* (Schimper) Jörgensen  
 = *Ceratium tripos lunula* Schimper  
*Ceratium macroceros* (Ehrenberg) Cleve  
 = *Peridinium macroceros* Ehrenberg  
*Ceratium massiliense* (Gourret) Jörgensen  
 = *Ceratium tripos* var. *massiliense* Gourret  
*Ceratium praelongum* (Lemmermann) Kofoid  
 = *Ceratium gravidum* var. *praelongum* Lemmermann  
*Ceratium pulchellum* Schröder  
 = *Ceratium tripos* var. *pulchellum* (Schröder) López  
 = *Ceratium tripos* subsp. *pulchellum* (Schröder) Peters  
*Ceratium trichoceros* (Ehrenberg) Kofoid  
 = *Peridinium trichoceros* Ehrenberg  
*Ceratium tripos* (O. F. Müller) Nitzsch  
 = *Cercaria tripos* O. F. Müller  
*Ceratocorys armata* (Schütt) Kofoid  
 = *Goniodoma acuminatum* var. *armatum* Schütt  
*Ceratocorys bipes* (Cleve) Kofoid  
 = *Goniodoma bipes* Cleve  
*Cochlodinium helix* (Pouchet) Lemmermann  
 = *Gymnodinium helix* Pouchet  
*Cochlodinium polykrikoides* Margalef  
 = *Cochlodinium heterolobatum* Silva  
*Coolia monotis* Meunier  
 = *Glenodinium monotis* (Meunier) Biecheler

- = *Ostreopsis monotis* (Meunier) Lindemann
- Corythodinium compressum* (Kofoid) Taylor
- = *Oxytoxum compressum* Kofoid
- Corythodinium tessellatum* (Stein) Loeblich Jr. & Loeblich III
- = *Pyrgidium tessellatum* Stein
- Crypthecodinium cohnii* Seligo in Grasse
- = *Crypthecodinium setense* Biecheler
- = *Glendodinium cohnii* Seligo in Cohn
- Dinophysis hastata* Stein
- = *Phalacroma hastatum* Pavillard
- Dinophysis odiosa* (Pavillard) Tai & Skogsberg
- = *Prodinophysis odiosa* (Pavillard) Loeblich III
- = *Phalacroma odiosum* Pavillard
- Dinophysis parvula* (Schütt) Balech
- = *Prodinophysis parvula* (Schütt) Balech
- = *Phalacroma parvulum* (Schütt) Jørgensen
- = *Phalacroma porodictyum* var. *parvula* Schütt
- Dinophysis porodictyum* (Stein) Abé
- = *Phalacroma porodictyum* Stein
- Dinophysis tripos* Gourret
- = *Dinophysis caudata* var. *tripos* (Gourret) Gail
- Diplopelta parva* (Abé) Matsuska
- = *Dissodium parvum* Abé
- Diplopsalis lenticula* Bergh
- = *Peridiniopsis lenticula* (Bergh) Starmach
- = *Dissodium lenticula* (Bergh) Loeblich III
- Diplopsalopsis orbicularis* (Paulsen) Meunier
- = *Diplopsalis orbicularis* (Paulsen) Paulsen
- = *Peridinium orbiculare* Paulsen
- Erythrospidinium agile* (Hertwig) Silva
- = *Erythrospis agile* Hertwig
- Fragilidium subglobosum* (von Stosch) Loeblich III
- = *Helgolandinium subglobosum* von Stosch
- Goniodoma polyedricum* (Pouchet) Jørgensen
- = *Triadinium polyedricum* (Pouchet) Dodge
- = *Heteraulacus polyedricus* (Pouchet) Drugg & Loeblich Jr.
- = *Peridinium polyedricum* Pouchet
- Goniodoma sphaericum* Murray & Whitting
- = *Triadinium sphaericum* (Murray & Whitting) Dodge

- = *Heteraulacus sphaericus* (Murray & Whitting) Loeblich III
- Gonyaulax digitale* (Pouchet) Kofoid
- = *Protoperidinium digitale* Pouchet
- Gonyaulax fragilis* (Schütt) Kofoid
- = *Steiniella fragilis* Schütt
- Gonyaulax grindleyi* Reinecke
- = *Peridiniopsis reticulata* (Claparède & Lachmann) Starmach
- = *Protoceratium reticulatum* (Claparède & Lachmann) Bütschli
- = *Peridinium reticulatum* Claparède & Lachmann
- Gonyaulax spinifera* (Claparède & Lachmann) Diesing
- = *Peridinium spiniferum* Claparède & Lachmann
- Gonyaulax verior* Sournia
- = *Gonyaulax diacantha* sensu Schiller
- = *Amylax diacantha* Meunier
- Gymnodinium breve* Davis
- = *Ptychodiscus brevis* (Davis) Steidinger
- Gymnodinium fuscum* (Ehrenberg) Stein
- = *Peridinium fuscum* Ehrenberg
- Gymnodinium mikimotoi* Miyaka & Kominami ex Oda
- = *Gymnodinium nagasakiense* Takyama & Adachi
- Gymnodinium pseudopalustre* (Woloszynska) Schiller
- = *Gymnodinium palustre* Woloszynska
- Gymnodinium sanguineum* Hirasaka
- = *Gymnodinium nelsonii* Martin
- = *Gymnodinium splendens* Lebour
- Gyrodinium fissum* (Levander) Kofoid & Swezy
- = *Gymnodinium fissum* Levander
- Gyrodinium spirale* (Bergh) Kofoid & Swezy
- = *Gymnodinium spirale* Bergh
- Herdmania littoralis* Dodge
- = *Gymnodinium agile* Herdman
- Heterocapsa niei* (Loeblich) Morrill & Loeblich III
- = *Cachonina niei* Loeblich
- Heterocapsa triquetra* (Ehrenberg) Balech
- = *Peridinium triquetrum* (Ehrenberg) Lebour
- = *Properidinium heterocapsa* (Stein) Meunier
- = *Glenodinium triquetrum* Ehrenberg
- Histioneis diomedeeae* Kofoid & Michener
- = *Parahistioneis diomedeeae* (Kofoid & Michener) Kofoid & Swezy

- Katodinium nieuportense* (Conrad) Loeblich Jr. & Loeblich III  
 = *Massartia nieuportensis* Conrad
- Katodinium glaucum* (Lebour) Loeblich III  
 = *Spirodinium glaucum* Lebour
- Katodinium rotundatum* (Lohmann) Loeblich III  
 = *Amphidinium rotundatum* Lohmann  
 = *Massartia rotundata* (Lohmann) Schiller
- Lingulodinium polyedrum* (Stein) Dodge  
 = *Gonyaulax polyedra* Stein
- Mesoporus globulus* (Schiller) Lillick  
 = *Porella globulus* Schiller
- Mesoporus perforatus* (Gran) Lillick  
 = *Dinoporella perforata* (Gran) Halim  
 = *Porothea perforata* (Gran) Silva  
 = *Exuviaella perforata* Gran
- Nematodinium armatum* (Dogiel) Kofoid & Swezy  
 = *Pouchetia armata* Dogiel
- Noctiluca scintillans* (Macartney) Kofoid & Swezy  
 = *Noctiluca miliaris* Suriray  
 = *Medusa scintillans* Macartney
- Ornithocercus thumii* (Schmidt) Kofoid & Skogsberg  
 = *Parelion thumii* Schmidt
- Pentapharsodinium dalei* Indelicato & Loeblich III  
 = *Peridinium faroense* sensu Dale
- Peridiniella catenata* (Levander) Balech  
 = *Gonyaulax catenata* (Levander) Kofoid  
 = *Amylax catenata* (Levander) Meunier  
 = *Peridinium catenata* Levander
- Peridinium cinctum* (O. F. Müller) Ehrenberg  
 = *Vorticella cincta* O. F. Müller
- Phalacroma argus* Stein  
 = *Prodinophysis argus* (Stein) Balech  
 = *Dinophysis argus* (Stein) Abé
- Phalacroma cuneus* Schütt  
 = *Prodinophysis cuneus* (Schütt) Balech  
 = *Dinophysis cuneus* (Schütt) Abé
- Phalacroma doryphorum* Stein  
 = *Prodinophysis doryphora* (Stein) Balech  
 = *Dinophysis doryphora* (Stein) Abé

- Phalacroma favus* Kofoid & Michener  
 = *Prodinophysis favus* (Kofoid & Michener) Balech  
 = *Dinophysis favus* (Kofoid & Michener) Abé
- Phalacroma mitra* Schütt  
 = *Prodinophysis mitra* (Schütt) Balech  
 = *Dinophysis mitra* (Schütt) Abé
- Phalacroma rapa* Stein  
 = *Prodinophysis rapa* (Stein) Balech  
 = *Dinophysis rapa* (Stein) Balech
- Phalacroma rotundatum* (Claparède & Lachmann) Kofoid & Michener  
 = *Prodinophysis rotundata* (Claparède & Lachmann) Balech  
 = *Dinophysis rotundata* Claparède & Lachmann
- Pheopolykrikos beauchampii* Chatton  
 = *Polykrikos beauchampii* (Chatton) Loeblich III
- Pheopolykrikos hartmannii* (Zimmerman) Matsuoka & Fukuyo  
 = *Polykrikos hartmannii* Zimmermann
- Podolampas bipes* var. *reticulata* (Kofoid) Taylor  
 = *Podolampas reticulata* Kofoid
- Polykrikos schwartzi* Bütschli  
 = *Polykrikos auricularia* Bergh
- Pratjetella medusoides* (Hertwig) Loeblich Jr. & Loeblich III  
 = *Leptodiscus medusoides* Hertwig
- Preperidinium meunieri* (Pavillard) Elbrächter  
 = *Diplopsalis minor* (Paulsen) Lindemann  
 = *Zygabikodinium lenticulatum* Loeblich Jr & Loeblich III  
 = *Diplopeltopsis minor* (Paulsen) Pavillard  
 = *Peridinium paulsenii* Mangin  
 = *Peridinium lenticulatum* Mangin  
 = *Diplopsalis lenticula* f. *minor* Paulsen
- Pronoctiluca acuta* (Lohmann) Schiller  
 = *Rhynchomonas acuta* Lohmann
- Prorocentrum balticum* (Lohmann) Loeblich III  
 = *Exuviaella baltica* Lohmann
- Prorocentrum compressum* (Bailey) Abé ex Dodge  
 = *Exuviaella compressa* (Bailey) Ostenfeld  
 = *Pyxidicula compressa* Bailey
- Prorocentrum gracile* Schütt  
 = *Prorocentrum hentschelii* Schiller
- Prorocentrum lima* (Ehrenberg) Dodge

- = *Exuviaella marina* var. *lima* (Ehrenberg) Schiller
- = *Exuviaella lima* (Ehrenberg) Bütschli
- = *Dinopyxis laevis* Stein
- = *Cryptomonas lima* Ehrenberg
- Prorocentrum marinum* (Cienkowski) Loeblich III
- = *Exuviaella marina* Cienkowski
- Prorocentrum mexicanum* Tafall
- = *Prorocentrum maximum*
- = *Prorocentrum rathymum* Loeblich, Shirley & Schmidt
- Prorocentrum minimum* (Pavillard) Schiller
- = *Exuviaella marie-lebouriae* Parke & Ballantine
- = *Prorocentrum marie-lebouriae* (Parke & Ballantine) Loeblich III
- = *Prorocentrum triangulatum* Martin
- = *Exuviaella minima* Pavillard
- Prorocentrum rostratum* Stein
- = *Prorocentrum styliferum* Lohmann
- = *Prorocentrum tenue* Lohmann
- Prorocentrum triestinum* Schiller
- = *Prorocentrum redfeldii* Bursa
- = *Prorocentrum pyrenoideum* Bursa
- Protoceratium spinulosum* (Murray & Whitting) Schiller
- = *Peridinium spinulosum* Murray & Whitting
- Protoperidinium brevipes* (Paulsen) Balech
- = *Peridinium brevipes* Paulsen
- Protoperidinium claudicans* (Paulsen) Balech
- = *Peridinium claudicans* Paulsen
- Protoperidinium compressum* (Nie) Balech
- = *Peridinium compressum* (Abé) Nie
- = *Congruentidium compressum* Abé
- Protoperidinium conicoides* (Paulsen) Balech
- = *Peridinium conicoides* Paulsen
- Protoperidinium conicum* (Gran) Balech
- = *Peridinium conicum* (Gran) Ostefeld & Schmidt
- = *Peridinium divergens* var. *conica* Gran
- Protoperidinium crassipes* (Kofoid) Balech
- = *Peridinium crassipes* Kofoid
- Protoperidinium depressum* (Bailey) Balech
- = *Peridinium depressum* Bailey
- Protoperidinium divaricatum* (Meunier) Balech

- = *Protoperidinium gainii* (Dangeard) Balech
- = *Peridinium gainii* Dangeard
- = *Peridinium divaricatum* Meunier
- Protoperidinium divergens* (Ehrenberg) Balech
- = *Glenodinium divergens* (Ehrenberg) Dangeard
- = *Peridinium divergens* Ehrenberg
- Protoperidinium elegans* (Cleve) Balech
- = *Peridinium elegans* Cleve
- Protoperidinium excentricum* (Paulsen) Balech
- = *Peridinium excentricum* Paulsen
- Protoperidinium fatulipes* (Kofoid) Balech
- = *Peridinium fatulipes* Kofoid
- Protoperidinium grande* (Kofoid) Balech
- = *Peridinium grande* Kofoid
- Protoperidinium latissimum* (Kofoid) Balech
- = *Peridinium pentagonoides* Balech
- = *Peridinium pentagonum* var. *depressum* Abé
- = *Peridinium latissimum* Kofoid
- Protoperidinium leonis* (Pavillard) Balech
- = *Peridinium leonis* Pavillard
- Protoperidinium mediterraneum* (Kofoid) Balech
- = *Peridinium steini mediterraneum* Kofoid
- Protoperidinium minutum* (Kofoid) Loeblich III
- = *Peridinium minutum* Kofoid
- Protoperidinium nudum* (Meunier) Balech
- = *Peridinium nudum* Meunier
- Protoperidinium oblongum* (Aurivillius) Parke & Dodge
- = *Peridinium oblongum* (Aurivillius) Cleve
- = *Peridinium divergens* var. *oblongum* Aurivillius
- Protoperidinium obtusum* (Karsten) Balech
- = *Peridinium obtusum* Karsten
- Protoperidinium oceanicum* (VanHöffen) Balech
- = *Peridinium oceanicum* VanHöffen
- Protoperidinium pallidum* (Ostenfeld) Balech
- = *Peridinium pallidum* Ostenfeld
- Protoperidinium pellucidum* Bergh
- = *Peridinium pellucidum* (Bergh) Schütt
- Protoperidinium pentagonum* (Gran) Balech
- = *Peridinium pentagonum* Gran



- Proto-peridinium punctulatum* (Paulsen) Balech  
= *Peridinium punctulatum* Paulsen
- Proto-peridinium pyrum* (Balech) Balech  
= *Peridinium pyrum* Balech
- Proto-peridinium quarnerense* (Schröder) Balech  
= *Peridinium quarnerense* Schröder  
= *Peridinium globulus* var. Stein
- Proto-peridinium saltans* (Meunier) Balech  
= *Peridinium saltans* Meunier
- Proto-peridinium simulum* (Paulsen) Balech  
= *Peridinium simulum* Paulsen
- Proto-peridinium solitarium* (Abé) Balech  
= *Peridinium solitarium* Abé
- Proto-peridinium subinerme* (Paulsen) Loeblich III  
= *Peridinium subinerme* Paulsen
- Proto-peridinium symmetricum* (Halim) Balech  
= *Peridinium symmetricum* Halim
- Proto-peridinium thorianum* (Paulsen) Balech  
= *Peridinium thorianum* Paulsen
- Pyrocystis fusiformis* Wyville-Thomson ex Murray  
= *Dissodinium fusiforme* (Wyville-Thomson ex Murray) Matzenauer
- Pyrocystis lunula* (Schütt) Schütt  
= *Dissodinium lunula* (Schütt) Pascher  
= *Diplodinium lunula* (Schütt) Klebs  
= *Gymnodinium lunula* Schütt
- Pyrocystis noctiluca* Murray ex Schütt  
= *Pyrocystis pseudonociluca* Wyville-Thomson in J. Murray  
= *Dissodinium pseudonociluca* Swift ex Elbrächter & Drebes
- Pyrodinium bahamense* var. *compressum* (Böhm) Steidinger, Tester, & Taylor  
= *Pyrodinium schilleri* (Matzenauer) Schiller  
= *Gonyaulax schilleri* Matzenauer  
= *Pyrodinium bahamense* f. *compressa* Böhm
- Pyrophacus steinii* (Schiller) Wall & Dale  
= *Pyrophacus horologicum* var. *steinii* Schiller
- Pyrophacus vancampoae* (Rossignol) Wall & Dale  
= *Tuberculodinium vancampoae* (Rossignol) Wall  
= *Pterospermopsis vancampoae* Rossignol
- Schuetiella mitra* (Schütt) Balech

- = *Gonyaulax mitra* (Schütt) Kofoid
- = *Oxytoxum gigas* Kofoid
- = *Steiniella mitra* Schütt
- Sclerodinium calyptoglyphe* (Lebour) Dodge
- = *Gyrodinium calyptoglyphe* Lebour
- Scrippsiella subsalsa* (Ostenfeld) Steidinger & Balech
- = *Peridinium subsalsum* Ostenfeld
- Scrippsiella trochoidea* (Stein) Balech
- = *Scrippsiella faeroense* (Paulsen) Balech & Soares
- = *Peridinium trochoideum* (Stein) Lemmermann
- = *Peridinium faeroense* Paulsen
- = *Glenodinium trochoideum* Stein
- Symbiodinium microadriaticum* Freudenthal
- = *Zooxanthella microadriatica* (Freudenthal) Loeblich III & Sherley
- = *Gymnodinium microadriaticum* (Freudenthal) Taylor
- Thecadinium kofoidii* (Herdman) Schiller
- = *Thecadinium petasatum* Kofoid & Skogsberg
- = *Phalocroma kofoidi* Herdman
- = *Amphidinium kofoidi* var. *petasatum* Herdman
- = *Amphidinium sulcatum* Herdman
- Thoracosphaera heimii* (Lohmann) Kamptner
- = *Thoracosphaera pelagica* Kamptner
- = *Syracosphaera heimii* Lohmann
- Torodinium teredo* (Pouchet) Kofoid & Swezy
- = *Gymnodinium teredo* Pouchet
- Warnowia fusus* (Schütt) Lindemann
- = *Pouchetia fusus* Schütt

## INDEX OF DINOFLAGELLATE TAXA

---

- |  |                                      |
|--|--------------------------------------|
| <i>Acanthogonyaulax</i> , 503                | <i>A. balechii</i> , 395, 492, 498   |
| <i>A. spinifera</i> , 502–504                | <i>A. catenella</i> , 491–492        |
| <i>Actiniscus</i> , 468                      | <i>A. cohorticula</i> , 492, 495     |
| <i>A. pentasterias</i> , 468–469             | <i>A. compressum</i> , 491–492       |
| <i>Adenoides</i> , 412, 548                  | <i>A. concavum</i> , 492–493         |
| <i>A. eludens</i> , 550                      | <i>A. excavatum</i> , 500            |
| <i>Alexandrium</i> , 406, 413, 482, 488–490, | <i>A. foedum</i> , 395, 494, 498     |
| 501, 506–507, 510, 519, 521                  | <i>A. fraterculus</i> , 490, 494–495 |
| <i>A. acatenella</i> , 490, 493              | <i>A. fukuyoi</i> , 490              |
| <i>A. affine</i> , 395, 490, 495             | <i>A. fundyense</i> , 491, 494       |
| <i>A. andersonii</i> , 490, 493, 497         | <i>A. hiranoi</i> , 494, 498         |
| <i>A. angustitabulatum</i> , 490–491, 497    | <i>A. ibericum</i> , 497             |

- A. insuetum*, 494, 496  
*A. kutnerae*, 491, 496–497  
*A. leei*, 491, 497  
*A. lusitanicum*, 493, 497  
*A. margalefii*, 498  
*A. minutum*, 488, 490, 495, 497  
*A. monilatum*, 395, 492, 496–497  
*A. ostenfeldii*, 496, 499  
*A. peruvianum*, 496, 499  
*A. pseudogonyaulax*, 494, 498–499  
*A. satoanum*, 500  
*A. tamarense*, 490, 493–494, 500  
*A. tamiyavanichi*, 495, 500  
*A. taylorii*, 498, 500  
*A. tropicale*, 496, 500  
*Amphidinium*, 444, 464, 467  
*A. carterae*, 443–444  
*A. globifera*, 426, 428  
*A. klebsii*, 445  
*A. operculatum*, 444–445  
*A. poecilochroum*, 443, 445  
*Amphidiniopsis*, 412, 546  
*A. kofoidii*, 546  
*Amphidoma*, 412, 414, 504  
*A. nucula*, 504–505  
*Amphisolenia*, 426  
*A. bidentata*, 426–427  
*A. globifera*, 426, 428  
*Amylax*, 412, 504, 506  
*A. alata*, 504  
*A. buxus*, 504  
*A. catenata*, 510  
*A. diacantha*, 509  
*A. triacantha*, 504–505  
*Apsteinia*  
*A. acuta*, 531  
*Balechina*, 461  
*B. coerulea*, 461–462  
*B. pachydermata*, 461  
*Blepharocysta*, 399, 414, 532–534  
*B. splendor-maris*, 533  
*Boreadinium*, 413, 527–528  
*B. pisiforme*, 527  
*Brachyadinium*, 468  
*B. capitatum*, 468–469  
*Cachonina*  
*C. niei*, 531  
*Centrodinium*, 412, 446, 516  
*C. elongatum*, 516  
*Ceratium*, 407, 412, 457, 469–470, 552  
*C. arcticum*, 476  
*C. arcuatum*, 471  
*C. arietinum*, 471, 479  
*C. bucephalum*, 471  
*C. candelabrum*, 471, 476  
*C. carriense*, 471, 481  
*C. concilians*, 479  
*C. contortum*, 472, 479  
*C. declinatum*, 472, 476  
*C. extensum*, 472  
*C. furca*, 471–473  
*C. furcoides*, 417  
*C. fusus*, 472–473  
*C. gibberum*, 472, 479  
*C. gravidum*, 473, 474  
*C. hexacanthum*, 474, 479  
*C. hircus*, 472  
*C. horridum*, 474, 480  
*C. incisum*, 473–474  
*C. inflatum*, 473–474  
*C. kofoidii*, 473, 475  
*C. limulus*, 475, 480  
*C. lineatum*, 473, 475  
*C. longipes*, 475–476  
*C. lunula*, 475, 481  
*C. macroceros*, 475, 481  
*C. massiliense*, 477  
*C. paradoxides*, 475, 480  
*C. pentagonum*, 476–477  
*C. platycorne*, 477, 480  
*C. pleuroceras*, 470  
*C. praelongum*, 473, 475, 477  
*C. pulchellum*, 478–479  
*C. ranipes*, 478, 483  
*C. symmetricum*, 478, 480  
*C. teres*, 476, 478  
*C. trichoceros*, 478, 481  
*C. tripos*, 476–478  
*C. vultur*, 398, 480, 482  
*Ceratocorys*, 412, 482  
*C. armata*, 395, 482–483  
*C. horrida*, 482–483  
*Citharistes*, 428  
*C. regius*, 427–428  
*Cladopyxis*, 412, 482  
*C. brachiolata*, 487  
*Cochlodinium*, 445  
*C. citron*, 443, 445  
*C. heterolobatum*, 446  
*C. polykrikoides*, 443, 446  
*C. strangulatum*, 445

- Coolia*, 412, 513, 515  
*C. monotis*, 397, 513–514  
*Corythodinium*, 399, 412, 516  
*C. constrictum*, 516  
*C. tessellatum*, 516–518  
*Crypthecodinium*, 411, 413, 487  
*C. cohnii*, 411, 488–489  
*C. setense*, 487  
*C. cuneus*, 487  
*Cymbodinium*, 466  
*C. elegans*, 465–466  
*Dinophysis*, 415, 426, 528  
*D. acuminata*, 429–430  
*D. acuta*, 406, 428–430  
*D. caudata*, 431–432, 434  
*D. dens*, 430–431  
*D. diegensis*, 431  
*D. fortii*, 430–431  
*D. hastata*, 432–433  
*D. lachmannii*, 429  
*D. lenticula*, 408  
*D. norvegica*, 429–430, 433  
*D. odiosa*, 430, 433  
*D. ovum*, 429  
*D. punctata*, 429  
*D. sacculus*, 429  
*D. schuettii*, 432–433  
*D. skagii*, 429  
*D. swezyii*, 433  
*D. tripos*, 431–432, 434  
*D. uracantha*, 432–434  
*Diplopelta*, 413, 527–528  
*D. bomba*, 398  
*D. parva*, 529  
*Diplopsalis*, 413, 528–529, 552  
*D. acuta*, 531  
*D. lenticula*, 529  
*D. minor*, 528  
*Diplopsalopsis*, 413, 528–529, 530  
*D. orbicularis*, 529  
*Dissodinium*, 519–520, 529  
*D. parvum*, 529  
*D. pseudolunula*, 520  
*Ensiculifera*, 413, 523, 526  
*E. carinata*, 524  
*E. mexicana*, 523–524  
*Entzia*  
*E. acuta*, 531  
*Erythrospidinium*, 403, 459  
*E. agile*, 394, 454, 459  
*Fragilidium*, 412, 520  
*F. mexicanum*, 521–522  
*F. fissile*, 521  
*F. heterolobum*, 396, 521  
*F. subglobosum*, 521  
*Gambierdiscus*, 412, 501–502  
*G. toxicus*, 397, 501  
*Gessnerium*, 488, 490, 499  
*G. mochimaensis*, 497  
*G. monilata*, 497  
*G. ostenfeldii*, 499  
*G. tamarensis*, 500  
*Glenodinium*, 513, 529, 531  
*G. acutum*, 531  
*G. cinctum*, 531  
*Goniodoma*, 413, 482, 501, 506, 521  
*G. acuminata*, 501  
*G. ostenfeldii*, 499  
*G. polyedricum*, 395, 501–502  
*G. sphaericum*, 417, 502–503  
*Goryaulax*, 396, 412, 457, 504–507  
*G. alaskensis*, 506  
*G. catenata*, 510  
*G. diacantha*, 509  
*G. diegensis*, 507  
*G. digitale*, 506–507, 509  
*G. excavata*, 500  
*G. fragilis*, 409, 506  
*G. globosa*, 499  
*G. grindleyi*, 396, 506, 508  
*G. mitra*, 512  
*G. monilata*, 497  
*G. ostenfeldii*, 499  
*G. polyedra*, 506, 509  
*G. polygramma*, 507–508  
*G. scrippsae*, 507–508  
*G. spinifera*, 506–508  
*G. tamarensis*, 499–500  
*G. tamarensis var. excavata*, 500  
*G. triacantha*, 504  
*G. trygvei*, 499  
*G. verior*, 396, 509  
*Gotoius*, 413, 529  
*G. abei*, 529  
*G. mutsuensis*, 529  
*Gymnodinium*, 387–388, 446, 456, 464, 467, 519, 531  
*G. abbreviatum*, 446, 450  
*G. breve*, 400, 447–448  
*G. catenatum*, 447–448  
*G. fusum*, 446, 456

- G. galatheanum*, 447–448  
*G. heterostriatum*, 449–450  
*G. mikimotoi*, 392, 400, 447–449, 452  
*G. nagasakiense*, 449  
*G. nelsonii*, 451  
*G. pulchellum*, 392, 448–449  
*G. sanguineum*, 450–451  
*G. splendens*, 451  
*Gyrodinium*, 392, 400, 451  
*G. aureolum*, 449, 452  
*G. estuariale*, 450, 452  
*G. fissum*, 452  
*G. instriatum*, 450, 452  
*G. lachryma*, 453–454  
*G. pellucidum*, 542  
*G. pingue*, 453  
*G. pepo*, 392  
*G. spirale*, 409, 451, 453–455  
*G. uncatenum*, 417, 450, 453  
*Herdmania*, 463  
*H. litoralis*, 462  
*Heteraulacus*, 501  
*H. ostefeldii*, 499  
*Heterocapsa*, 413, 446, 530  
*H. niei*, 498, 531–532  
*H. pigmaea*, 531  
*H. triquetra*, 498, 531–532  
*Heterodinium*, 413, 513  
*H. milneri*, 513  
*H. rigdenae*, 513–514  
*H. scrippsae*, 513  
*Histioneis*, 413, 433  
*H. depressa*, 433–434  
*H. mitchellana*, 433  
*H. remora*, 433  
*Katodinium*, 453, 467, 531  
*K. fungiforme*, 455  
*K. glaucum*, 392, 454–455  
*K. nieuportense*, 453  
*K. rotundatum*, 454, 456  
*Kofoidinium*, 463  
*K. velleloides*, 464–465  
*Kolkwitzia*  
*K. acuta*, 531  
*K. gibbera*, 531  
*Lepidodinium*, 456  
*L. viride*, 456  
*Leptodiscus*, 466  
*L. medusoides*, 466  
*Lingulodinium*, 412, 506, 509  
*L. machaerophorum*, 509  
*L. polyedrum*, 396  
*Lissodinium*, 414, 533–534  
*L. schilleri*, 532–533  
*L. orcadense*, 399  
*Mesoporos*, 418–419  
*M. globulus*, 418  
*M. perforatus*, 419  
*Metaphalacroma*, 436  
*M. skogsbergii*, 436  
*Nematodinium*, 401, 403, 459  
*N. armatum*, 394, 454, 459  
*N. partitum*, 459  
*Noctiluca*, 466  
*N. scintillans*, 465–466  
*Oblea*, 413, 528–529  
*O. baculifera*, 529–530  
*Ornithocercus*, 414, 436, 552  
*O. heteroporus*, 435–436  
*O. magnificus*, 435–436  
*O. quadratus*, 435–436  
*O. splendidus*, 435, 437  
*O. steinii*, 435–437  
*O. thumii*, 435–437  
*Ostreopsis*, 412, 513–515  
*O. heptagona*, 397, 515  
*O. lenticularis*, 514–515  
*O. ovata*, 514–515  
*O. siamensis*, 514–516  
*Oxyphysis*, 442  
*O. oxytoxoides*, 442–443  
*Oxyrrhis*, 389, 551  
*O. marina*, 389, 548, 551  
*Oxytoxum*, 412, 512, 517–518  
*O. gigas*, 512  
*O. scolopax*, 399, 517, 519  
*O. variabile*, 519  
*Paleophalacroma*, 412, 487  
*P. uncinatum*, 399, 483, 487  
*P. verrucosum*, 487  
*Pentapharsodinium*, 413, 524, 526  
*P. dalei*, 524–525  
*Peridiniella*, 413, 510  
*P. catenata*, 510–511  
*P. sphaeroidea*, 510  
*Peridinium*, 414, 457, 513, 524, 526, 530–531  
*P. cinctum*, 531

- P. faeroense*, 524  
*P. latum*, 531  
*P. lubiensiforme*, 417  
*P. paulsenii*, 530  
*P. punctulatum*, 545  
*P. spiniferum*, 507  
*Pheopolykrikos*, 457  
*P. beauchampii*, 457  
*P. hartmannii*, 457–458  
*Phalacroma*, 414, 429, 437  
*P. argus*, 437–438  
*P. cuneus*, 438–439  
*P. doryphorum*, 439, 443  
*P. favus*, 438–439  
*P. mitra*, 438–439  
*P. productyum*, 436  
*P. rapa*, 438–439  
*P. rotundatum*, 406, 438–439  
*P. verrucosum*, 487  
*Pleromonas*, 551  
*P. erosa*, 451  
*Podolampas*, 414, 533–534  
*P. bipes*, 399, 534  
*P. elegans*, 534  
*P. palmipes*, 534–535  
*Polykrikos*, 400, 402, 457  
*P. barnegatensis*, 457  
*P. kofoidii*, 457–458  
*P. schwartzii*, 394, 457–458  
*Pomatodinium*, 464  
*P. impatiens*, 464–465  
*Preperidinium*, 413, 528  
*P. meunieri*, 530  
*Pronoctiluca*, 467  
*P. acuta*, 465, 467  
*P. pelagica*, 467  
*Prorocentrum*, 389, 400, 402, 413–414, 418–419, 429  
*P. arcuatum*, 420–421  
*P. balticum*, 420, 422, 425  
*P. belizeanum*, 420, 422–423  
*P. compressum*, 422  
*P. concavum*, 420, 423  
*P. dentatum*, 421, 423  
*P. emarginatum*, 422–423  
*P. gracile*, 421, 424–425  
*P. hentscheli*, 424  
*P. hoffmannianum*, 420, 423, 425  
*P. lima*, 404, 420–421, 424  
*P. maculosum*, 424  
*P. mariae-lebourae*, 425  
*P. marinum*, 404  
*P. maximum*, 421, 424  
*P. mexicanum*, 424  
*P. micans*, 404, 421, 424, 426  
*P. minimum*, 420, 422, 425  
*P. rathymum*, 424  
*P. redfeldii*, 416, 424, 426  
*P. rostratum*, 421, 424–425  
*P. sabulosum*, 425  
*P. scutellum*, 422, 425  
*P. triestinum*, 421, 426  
*P. triangulatum*, 425  
*Protoceratium*, 507, 510  
*P. aceros*, 510  
*P. reticulatum*, 506  
*P. spinulosum*, 510–511  
*Protogonyaulax*, 488  
*P. globosa*, 499  
*P. tamarensis*, 500  
*Protoperidinium*, 388, 407–408, 413, 506, 510, 513, 526, 534–535  
*P. avellana*, 546  
*P. brevipes*, 536, 544  
*P. claudicans*, 536–537, 541  
*P. conicoides*, 538  
*P. conicum*, 538, 542  
*P. crassipes*, 538, 543  
*P. depressum*, 389, 538–540  
*P. divergens*, 398, 538, 543  
*P. elegans*, 540, 544  
*P. excentricum*, 540  
*P. fatulipes*, 540, 544  
*P. grande*, 540, 544  
*P. latissimum*, 545  
*P. leonis*, 537, 541–542  
*P. metananum*, 536  
*P. minutum*, 541  
*P. murrayii*, 541  
*P. nudum*, 541  
*P. oblongum*, 539, 541–542  
*P. obtusum*, 541–542  
*P. oceanicum*, 536, 539, 541–542  
*P. pallidum*, 536, 542, 544–545  
*P. pellucidum*, 404, 544  
*P. parthenopes*, 542–543  
*P. pellucidum*, 542  
*P. pentagonum*, 539, 545  
*P. punctulatum*, 537  
*P. quarnerense*, 545  
*P. quinquecorne*, 524  
*P. steidingerae*, 541

- P. subinermis*, 537, 545  
*P. thorianum*, 543, 546  
*P. truncatum*, 540  
*Ptychodiscus*, 446, 463  
*P. brevis*, 447  
*P. carinatus*, 463  
*P. inflatus*, 463  
*P. noctiluca*, 462–463  
*Pyrocystis*, 413, 519  
*P. acutallanceolata*, 520  
*P. gerbaultii*, 520  
*P. lunula*, 518–520  
*P. minima*, 520  
*P. noctiluca*, 518, 520  
*P. obtusa*, 520  
*P. pseudonoctiluca*, 520  
*P. robusta*, 520  
*Pyrodinium*, 388, 413, 488, 503  
*P. bahamense* var. *bahamense*, 396, 502–503  
*P. bahamense* var. *compressum*, 503  
*P. monilatum*, 497  
*P. phoneus*, 499  
*Pyrophacus*, 413, 523  
*P. horologium*, 397, 522–523  
*P. steinii*, 397, 522–523  
*Roscoffia*, 412, 546  
*R. capitata*, 546–547  
*Schuetziella*, 412, 512  
*S. mitra*, 511–512  
*Scrippsiella*, 413, 446, 457, 524–525  
*S. arenicola*, 527  
*S. caponii*, 527  
*S. gregaria*, 527  
*S. minima*, 527  
*S. precaria*, 525–526  
*S. subsalsa*, 526  
*S. sweeneyae*, 525  
*S. trochoidea*, 398, 525–527  
*Sinophysis*, 442  
*S. microcephala*, 442–443  
*Spatulodinium*, 464  
*S. pseudonoctiluca*, 464–465  
*Spiniferodinium*, 549  
*S. galeiforme*, 549  
*Spiraulax*, 412, 512  
*S. jolliffei*, 512  
*S. kofoidii*, 511–512  
*Spirodinium*  
*S. glaucum*, 455  
*Steiniella*, 506  
*S. mitra*, 512  
*Symbiodinium*, 405, 460, 462  
*S. microadriaticum*, 460–461  
*Thecadinium*, 412, 546–547  
*T. kofoidii*, 546–548  
*T. petasatum*, 547  
*Thoracosphaera*, 547  
*T. heimii*, 547, 549  
*Torodinium*, 456  
*T. robustum*, 456  
*T. teredo*, 454, 456  
*Triadinium*, 501  
*T. ostensfeldii*, 499  
*Triposolenia*, 428  
*T. truncata*, 427–428  
*Warnowia*, 394, 400, 460  
*W. polyphemus*, 454, 460  
*W. fusus*, 460  
*Woloszynskia*, 446, 467  
*W. reticulata*, 467  
*Zygabikodinium*, 530  
*Z. lenticulatum*, 530

## REFERENCES

- Abé, T. H. 1936a. Report of the biological survey of Mutsu Bay. 29. Notes of the protozoan fauna of Mutsu Bay. II. Genus: *Peridinium*: Subgenus: *Archaeoperidinium*. *Science Reports of the Tohoku University, 4th Series, Biology* 10:639–686.  
 Abé, T. H. 1936b. Report of the biological survey of Mutsu Bay. 30. Notes on the protozoan fauna of Mutsu Bay. III. Subgenus *Protoperidinium*: Genus *Peridinium*. *Science Reports of the Tohoku University, 4th Series, Biology* 11:19–48.  
 Abé, T. H. 1941. Studies on the protozoan fauna of Shimoda Bay. I. The *Diplopsalis* group. *Records of Oceanographic Works in Japan* 12:121–144.

- Abé, T. H. 1966. The armoured Dinoflagellata: I. Podolampidae. *Publications of the Seto Marine Biology Laboratory* 14:129–154.
- Abé, T. H. 1967a. The armoured Dinoflagellata: II. Prorocentridae and Dinophysidae (A). *Publications of the Seto Marine Biology Laboratory* 14:1369–1389.
- Abé, T. H. 1967b. The armoured Dinoflagellata: II. Prorocentridae and Dinophysidae (B). *Dinophysis* and its allied genera. *Publications of the Seto Marine Biology Laboratory* 15:37–78.
- Abé, T. H. 1967c. The armoured Dinoflagellata: II. Prorocentridae and Dinophysidae (C). *Ornithocercus*, *Histioneis*, *Amphisolenia* and others. *Publications of the Seto Marine Biology Laboratory* 15:79–116.
- Abé, T. H. 1981. Studies on the family Peridinidae, an unfinished monograph of the armoured Dinoflagellata. In "Publications of the Seto Marine Biological Laboratory Special Publication Series," pp. 409.
- Adamich, M., & Sweeney, B. M. 1976. The preparation and characterization of *Gonyaulax* spheroplasts. *Planta* 130:1–6.
- Akselman, R., & Keupp, H. 1990. Recent obliquipithonelloid calcareous cysts of *Scrippsiella patagonica* sp. nov. (Peridiniaceae, Dinophyceae) from plankton of the Golfo San Jorge (Patagonia, Argentina). *Marine Micropalaentology* 16:169–179.
- Andreis, C., Ciapi, M. D., & Rodondi, G. 1982. The thecal surface of some Dinophyceae: A comparative SEM approach. *Botanica Marina* 25:225–236.
- Balech, E. 1951. Deuxieme contribution a la connaissance des Peridinium. *Hydrobiologia* 3:305–330.
- Balech, E. 1956. Etude des dinoflagelles du sable de Roscoff. *Revue Algologique* 2:29–52.
- Balech, E. 1959. Two new genera of dinoflagellates from California. *Biological Bulletin* 116:195–203.
- Balech, E. 1963. Dos dinoflagelados de una laguna salobre de la Argentina. *Notas del Museo de La Plata Zoología* 20:111–123.
- Balech, E. 1964a. El genero *Cladopyxis*. *Hidrobiologia* 1:27–39.
- Balech, E. 1964b. El plancton de Mar del Plata durante el periodo 1961–62 (Buenos Aires, Argentina). *Instituto de Biología Marina, Mar del Plata, Argentine Republic, Boletín* 4:1–49.
- Balech, E. 1964c. Tercera contribucion al conocimiento del genero *Peridinium*. *Museo Argentino de ciencias naturales "Bernadino Rivadavia" e Instituto nacional de investigación de las ciencias naturales, Revista, Hidrobiología* 1:179–195.
- Balech, E. 1967a. Dinoflagelados nuevos o interesantes del Golfo de Mexico y Caribe. *Museo Argentino de ciencias naturales "Bernadino Rivadavia" e Instituto nacional de investigación de las ciencias naturales, Revista, Hidrobiología* 2:77–126.
- Balech, E. 1967b. *Palaeophalacroma* Schiller, otro miembro de la familia Cladopyxidae (Dinoflagellata). *Neotropica* 13:105–112.
- Balech, E. 1973a. Cuarta contribucion al conocimiento del genero *Protoperidinium*. *Museo Argentino de ciencias naturales "Bernadino Rivadavia" e Instituto nacional de investigación de las ciencias naturales, Revista, Hidrobiología* 3:347–381.
- Balech, E. 1973b. Segunda contribucion al conocimiento del microplancton del Mar de Bellingshausen. In "Contrib. Instituto Antartico Argentino," No. 107, pp. 63.
- Balech, E. 1974. El genero *Protoperidinium* Bergh, 1881 (*Peridinium* Ehrenberg, 1931, partim). *Museo Argentino de ciencias naturales "Bernadino Rivadavia" e Instituto nacional de investigación de las ciencias naturales, Revista, Hidrobiología* 4:1–79.
- Balech, E. 1976a. Clave ilustrada de dinoflagelados antarticos. *Publications of the Institute Antartic Argentina Buenos Aires* 11:1–99.
- Balech, E. 1976b. Notas sobre el genero *Dinophysis* (Dinoflagellata). *Physis A* 35:183–193.
- Balech, E. 1976c. Some Norwegian *Dinophysis* species (Dinoflagellata). *Sarsia* 61:75–94.
- Balech, E. 1976d. Sur quelques *Protoperidinium* (Dinoflagellata) de Golfe du Lion. *Vie Milieu* 26:27–46.



- Balech, E. 1977a. *Cachonina niei* Dinoflagellata and its variations. *Physis A* 36:59–64.
- Balech, E. 1977b. Cuatro especies de *Gonyaulax sensu lato*, y consideraciones sobre el genero (Dinoflagellata). *Museo Argentino de ciencias naturales "Bernadino Rivadavia" e Instituto nacional de investigación de las ciencias naturales, Revista, Hidrobiología* 5:115–136.
- Balech, E. 1979a. El genero *Goniodoma* Stein (Dinoflagellata). *Lilloa* 35:97–109.
- Balech, E. 1979b. El genero *Pyrophacus* Stein (Dinoflagellata). *Physis* 38:27–38.
- Balech, E. 1979c. Tres dinoflagelados nuevos o interesantes de aguas Brasileñas. *Boletim do Instituto Oceanográfico* 28:55–64.
- Balech, E. 1980. On thecal morphology of dinoflagellates with special emphasis on cingular and sulcal plates. *Anales del Centro de Ciencias del Mar y Limnología Universidad Nacional Autonoma de Mexico* 7:57–68.
- Balech, E. 1985a. The genus *Alexandrium* or *Gonyaulax* of the tamarensis group. In "Toxic Dinoflagellates" (D. M. Anderson, A. W. White, & D. G. Baden, eds.), pp. 33–38. Elsevier, New York.
- Balech, E. 1985b. A revision of *Pyrodinium bahamense*, Dinoflagellata. *Review of Palaeobotany and Palynology* 45:17–34.
- Balech, E. 1988a. Los Dinoflagelados del Atlantico Sudoccidental. In "Publicaciones Especiales del Instituto Espanol de Oceanografía," No. 1, pp. 310. Madrid, Spain.
- Balech, E. 1988b. Una especie nueva del genero *Fragilidium* (Dinoflagellata) de la bahia de Chamela, Jalisco, Mexico. *Anales del Instituto Biologica UNAM, Series Zoologica* 58:479–486.
- Balech, E. 1989. Redescription of *Alexandrium minutum* Halim (Dinophyceae) type species of the genus *Alexandrium*. *Phycologia* 28:206–211.
- Balech, E. 1990a. Four new dinoflagellates. *Helgoländer Meeresuntersuchungen* 44:387–396.
- Balech, E. 1990b. A short diagnostic description of *Alexandrium*. In "Toxic Marine Phytoplankton" (E. Graneli, B. Sundstrom, L. Edler, & D. M. Anderson, eds.), pp. 77. Elsevier, New York.
- Balech, E. 1994. Three new species of the genus *Alexandrium* (Dinoflagellata). *Transactions of the American Microscopical Society* 113:216–220.
- Balech, E. 1995. "The Genus *Alexandrium* Halim (Dinoflagellata)." Sherkin Island Press (in press).
- Balech, E., & Tangen, K. 1985. Morphology and taxonomy of toxic species in the tamarensis group (Dinophyceae) *Alexandrium excavatum* (Braarud) comb. nov. and *Alexandrium ostenfeldii* (Paulsen) comb. nov. *Sarsia* 70:333–343.
- Banaszak, A. T., Inglesias-Prieto, R., & Trench, R. K. 1993. *Scrippsiella velellae* sp. nov. (Peridinales) and *Gleodinium viscum* sp. nov. (Phytodinales), dinoflagellate symbionts of two hydrozoans (Cnidaria). *Journal of Phycology* 29:517–528.
- Bardouil, M., Berland, B., Grzebyk, D., & Lassus, P. 1991. L'existence de kystes chez les Dinophyales. *Comptes rendus des séances de L'Academie des sciences Serie III* 312:663–669.
- Beam, C. A., & Himes, M. 1987. Electrophoretic characterization of members of the *Crypthecodinium cobnii* (Dinophyceae) species complex. *Journal of Protozoology* 34:204–217.
- Below, R. 1987a. Evolution and systematics of dinoflagellate cysts of the order Peridinales. I. Basic general principles and the subfamily Rhaetogonyaulacoidae, family Peridiniaceae. *Palaeontographica Abteilung B* 205:1–164.
- Below, R. 1987b. Evolution and systematics of dinoflagellate cysts of the order Peridinales. II. Cladophyxiaceae and Valvaeodiniaceae. *Palaeontographica Abteilung B* 206:1–115.
- Berland, B. 1982. Image reversal in micorscopy. *Transactions of the American Microscopical Society* 101:174–180.
- Besada, E. G., Loeblich, A. R. Jr., & Loeblich, A. R., III. 1982. Observations on tropical, benthic dinoflagellates from ciguatera-endemic areas: *Coolia*, *Gambierdiscus*, and *Ostreopsis*. *Bulletin of Marine Science* 32: 723–735.
- Biecheler, B. 1952. Recherches sur les peridinens. *Bulletin Biologique de la France et de la Belgique (Suppl.)* 36:1–149.
- Blank, R. J., & Trench, R. K. 1986. Nomenclature of endosymbiotic dinoflagellates. *Taxon* 35:286–294.

- Boalch, G. T. 1969. The dinoflagellate genus *Ptychodiscus* Stein. *Journal of the Marine Biological Association of the United Kingdom* 49:781–784.
- Boltovskoy, A. 1975. Estructura y esteroultraestructura tecal de Dinoflagelados. II. *Peridinium cinctum* (Müller) Ehrenberg. *Physis Buenos Aires* 34:73–84.
- Borgese, M. B. 1987. Two armored dinoflagellates from the southwestern Atlantic Ocean: A new species of *Protoperidinium* and a first record and redescription for *Gonyaulax alaskensis* Kofoid. *Journal of Protozoology* 34:332–337.
- Bouck, G. B., & Sweeney, B. M. 1966. The fine structure and ontogeny of trichocysts in marine dinoflagellates. *Protoplasma* 61:205–223.
- Buchanan, R. J. 1968. Studies at Oyster Bay in Jamaica, West Indies. IV. Observations on the morphology and asexual cycle of *Pyrodinium bahamense* Plate. *Journal of Phycology* 4:272–277.
- Bujak, J. P., & Williams, G. L. 1981. The evolution of dinoflagellates. *Canadian Journal of Botany* 59:2077–2087.
- Burkholder, J. M., Noga, E. J., Hobbs, C. W., Glasgow, H. B., Jr., & Smith, S. A. 1992. New “phantom” dinoflagellate is the causative agent of major estuarine fish kills. *Nature* 358:407–410 (see Errata in *Nature* 360:768).
- Burkholder, J. M., Glasgow, H. B., Jr., & Steidinger, K. A. 1995. Stage transformations in the complex life cycle of an ichthyotoxic “ambush predator” dinoflagellate. In “Harmful Marine Algal Blooms” (P. Lassus, G. Arzul, E. Erard, P. Gentien, & C. Marañon, eds.), pp. 567–572. Lavoisier, Cachan Cedex, France.
- Burrells, W. 1977. “Microscope Technique. A Comprehensive Handbook for General and Applied Microscopy,” pp. 574. Halstead Press.
- Bursa, A. S. 1959. The genus *Prorocentrum* Ehrenberg. Morphodynamics, protoplasmic structures and taxonomy. *Canadian Journal of Botany* 37:1–30.
- Bursa, A. 1969. *Actiniscus canadensis* n. sp., *A. pentasterias* Ehrenberg v. *arcticus* n. var., *Pseudoactiniscus apentasterias* n. gen., n. sp., marine relicts in Canadian arctic lakes. *Journal of Protozoology* 16:411–418.
- Cachon, J., & Cachon, M. 1967a. Contribution a l'étude des Noctilucidae Saville-Kent. I. Les Kofoidininae Cachon J. & M. evolution, morphologique et systematique. *Protistologica* 3:427–444.
- Cachon, J., & Cachon, M. 1967b. *Cymbodinium elegans* nov. gen. nov. sp. péridinien Noctilucidae Saville-Kent. *Protistologica* 3:313–318.
- Cachon, J., & Cachon, M. 1968. *Filodinium hovassei* nov. gen., nov. sp. Péridinien phoretique d'Appendiculaires. *Protistologica* 4:15–18.
- Cachon, J., & Cachon, M. 1969. Contribution a l'étude des Noctilucidae Saville-Kent. Évolution, morphologique, cytologie, systematique. *Protistologica* 5:11–33.
- Cachon, J., & Cachon, M. 1987. Parasitic dinoflagellates. In “The Biology of Dinoflagellates” (F. J. R. Taylor, ed.), pp. 571–610. Blackwell, Oxford.
- Cachon, J., & Cachon-Enjumet, M. 1966. *Pomatodinium impatiens* nov. gen. nov. sp. Peridinien Noctilucidae Kent. *Protistologica* 2:23–30.
- Campbell, P. H. 1973. Studies on brackish water phytoplankton. University of North Carolina Sea Grant Publication UNC SG-73-07, pp. 406.
- Carbonell-Moore, M. C. 1991. *Lissodinium* Matzenauer, emend., based upon the rediscovery of *L. schilleri* Matz., another member of the family Podolampadaceae Lindemann (Dinophyceae). *Botanica Marina* 34:327–340.
- Carbonell-Moore, M. C. 1992. *Blepharocysta hermosillai*, sp. nov. a new member of the family Podolampadaceae Lindemann (Dinophyceae). *Botanica Marina* 35:273–281.
- Carbonell-Moore, M. C. 1993. Further observations on the genus *Lissodinium* Matz., emend. Carbonell-Moore (Dinophyceae), with descriptions of seventeen new species. *Botanica Marina* 36:561–587.

- Carty, S., & Cox, E. R. 1986. *Kansodinium* gen. nov. and *Durinskia* gen. nov.: Two genera of freshwater dinoflagellates (Pyrrhophyta) *Phycologia* 25:197–204.
- Chatton, E. 1933. *Pheopolykrikos beauchampii* nov. gen. nov. sp., dinoflagelle polydinide autotrophe, dans l'étang de Thau. *Bulletin de la Societe Zoologique de France* 58:251–254.
- Chatton, E. 1952. Classe des Dinoflagelles ou Peridinien. In "Traite de Zoologie, Anatomie, Systematique, Biologie" (P.-P. Grasse, ed.), Vol. 1, fasc. 1, Protozoaires, Generalites, Flagelles, pp. 309–406. Masson et Cie, Paris.
- Coats, D. W., Tyler, M. A., & Anderson, D. A. 1984. Sexual processes in the life cycle of *Gyrodinium uncatenum* (Dinophyceae): A morphogenetic overview. *Journal of Phycology* 20:351–361.
- Cox, E. R., & Arnott, H. J. 1971. The ultrastructure of the theca of the marine dinoflagellate, *Ensiculifera loeblichii* sp. nov. In "Contributions in Phycology" (B. C. Parker & R. M. Brown Jr., eds.), pp. 121–136. Allen Press, Lawrence, KS.
- Crawford, R. M., & J. D. Dodge. 1971. The dinoflagellate genus *Woloszynskia*. II. The fine structure of *W. coronata*. *Nova Hedwigia* XXII:699–719.
- Crawford, R. M., Dodge, J. D., & Happey, C. M. 1970. The dinoflagellate genus *Woloszynskia*. I. Fine structure and ecology of *W. tenuissimum* from Abbot's pool, Somerset. *Nova Hedwigia* XIX:825–840.
- Dale, B. 1977a. Cysts of the toxic red-tide dinoflagellate *Gonyaulax excavata* (Braarud) Balech from Oslofjorden, Norway. *Sarsia* 63:29–34.
- Dale, B. 1977b. New observations on *Peridinium faeroense* Paulsen (1905), and classification of small orthoperidinioid dinoflagellates. *British Phycological Journal* 12:241–253.
- Dale, B. 1978. Acitarchous cysts of *Peridinium faeroense* Paulsen: Implications for dinoflagellate systematics. *Palynology* 2:187–193.
- Dale, B. 1979. Collection, preparation and identification of dinoflagellate resting cysts. In "Toxic Dinoflagellate Blooms" (D. L. Taylor & H. H. Seliger, eds.), pp. 443–452. Elsevier, New York.
- Dale, B. 1983. Dinoflagellate resting cysts: "benthic" plankton. In "Survival Strategies of the Algae," (G. A. Fryxell, ed.), pp. 69–136. Cambridge University Press, London.
- Dale, B. 1986. Life cycle strategies of oceanic dinoflagellates. In "Pelagic Biogeography," (A. C. Pierrot-Bults, S. van der Spoel, B. J. Zahuranec, & R. K. Johnson, eds.), pp. 65–72. UNESCO Technical Papers in Marine Science, Paris.
- Dale, B., Montresor, M., Zingone, A., & Zonneveld, K. 1993. The cyst-motile stage relationships of the dinoflagellates *Diplopetala symmetrica* and *Diplopsalopsis latipeltata*. *European Journal of Phycology* 28:129–137.
- Delgado, M., & Fortuño, J. M. 1991. Atlas de fitoplancton del Mar Mediterraneo. *Scientia Marina* 55 (Suppl. 1):1–133.
- Dodge, J. D. 1966. The dinophyceae. In "The Chromosomes of the Algae," (M. B. E. Godward, ed.), pp. 96–115. Edward Arnold, London.
- Dodge, J. D. 1973. "The Fine Structure of Algal Cells," pp. 261. Academic Press, London.
- Dodge, J. D. 1975. The Procoentrales (Dinophyceae). II. Revision of the taxonomy within the genus *Prorocentrum*. *Botanical Journal of the Linnean Society* 71:103–125.
- Dodge, J. D. 1981. Three new generic names in the Dinophyceae: *Herdmania*, *Sclerodinium*, and *Triadinium* to replace *Heteraulacus* and *Goniodoma*. *British Phycological Journal* 16:273–280.
- Dodge, J. D. 1982. "Marine Dinoflagellates of the British Isles," pp. 303. Her Majesty's Stationery Office, London.
- Dodge, J. D. 1983. Ornamentation of thecal plates in *Proto-peridinium* (Dinophyceae) as seen by scanning electron microscopy. *Journal of Plankton Research* 5:119–127.
- Dodge, J. D. 1985. "Atlas of Dinoflagellates: A Scanning Electron Microscope Study," pp. 119. Farrand Press, London.

- Dodge, J. D. 1987. A hypothetical pore in some species of *Protoperidinium*, Dinophyceae. *British Phycological Journal* 22:335–338.
- Dodge, J. D. 1989. Some revisions of the family Gonyaulacaceae (Dinophyceae) based on a scanning electron microscope study. *Botanica Marina* 32:275–298.
- Dodge, J. D., & Crawford R. M. 1968. Fine structure of the dinoflagellate *Amphidinium carteri* Hulburt. *Protistologica* 4:231–242.
- Dodge, J. D., & Crawford R. M. 1970. A review of the theca fine structure in the Dinophyceae. *Journal of the Linnean Society of Botany* 63:53–67.
- Dodge, J. D., & Crawford, R. M. 1971. Fine structure of the dinoflagellate *Oxyrrhis marina*. I. The general structure of the cell. *Protistologica* 7:295–304.
- Dodge, J. D., & Greuet, C. 1987. Dinoflagellate ultrastructure and complex organelles. In “The Biology of Dinoflagellates” (F. J. R. Taylor, ed.), Botanical Monographs vol. 21, pp. 92–142. Blackwell, Oxford.
- Dodge, J. D., & Hermes, H. 1981. A revision of the *Diplopsalis* group of dinoflagellates (Dinophyceae) based on material from the British Isles. *Botanical Journal of the Linnean Society* 83:15–26.
- Dodge, J. D., & Lewis, J. 1986. A further SEM study of armoured sand-dwelling marine dinoflagellates. *Protistologica* 22:221–230.
- Dodge, J. D., & Saunders R. D. 1985a. A partial revision of the genus *Oxytoxum* (Dinophyceae) with the aid of scanning electron microscopy. *Botanica Marina* 28:99–122.
- Dodge, J. D., & Saunders, R. D. 1985b. An SEM study of *Amphidoma nucula* (Dinophyceae) and description of the thecal plates in *A. caudata*. *Archiv für Protistenkunde* 129:89–99.
- Dodge, J. D., & Toriumi, S. 1993. A taxonomic revision of the *Diplopsalis* group (Dinophyceae). *Botanica Marina* 36:137–147.
- Eaton, G. L. 1980. Nomenclature and homology in peridinialean dinoflagellate plate patterns. *Palaeontology* 23:667–688.
- Elbrächter, M., & Drebes, G. 1978. Life cycles, phylogeny, and taxonomy of *Dissodinium* and *Pyrocystis* (Dinophyta). *Helgolander wissenschaftliche Meeresuntersuchungen* 31:347–366.
- Elbrächter, M. 1979. On the taxonomy of unarmored dinophytes (Dinophyta) from the northwest African upwelling region. *Meteor Forschungsergebnisse Reihe* 30:1–22.
- Elbrächter, M. 1993. *Kolkuwitziella* Lindemann 1919 and *Preperidinium* Mangin 1913: Correct genera names in the *Diplopsalis*-group (Dinophyceae). *Nova Hedwigia* 56:173–178.
- Elbrächter, M., Hemleben, C., & Spindler, M. 1987. On the taxonomy of the lunate *Pyrocystis* species (Dinophyta). *Botanica Marina* 30:233–241.
- Evitt, W. R. 1985. “Sporopollenin Dinoflagellate Cysts: Their Morphology and Interpretation,” pp. 333. American Association of Stratigraphic Palynology Association.
- Faust, M. A. 1974. Micromorphology of a small dinoflagellate *Prorocentrum mariae-lebouriae* (Parke & Ballantine) comb. nov. *Journal of Phycology* 10:315–332.
- Faust, M. A. 1990a. Cysts of *Prorocentrum marinum* (Dinophyceae) in floating detritus at Twin Cays, Belize mangrove habitats. In “Toxic Marine Phytoplankton” (E. Graneli, B. Sundstrom, L. Edler, & D. M. Anderson, eds.), pp. 138–143. Elsevier, New York.
- Faust, M. A. 1990b. Morphologic details of six benthic species of *Prorocentrum* (Pyrrhophyta) from a mangrove island, Twin Cays, Belize, including two new species. *Journal of Phycology* 26:548–558.
- Faust, M. A. 1991. Morphology of ciguatera-causing *Prorocentrum lima* (Pyrrhophyta) from widely differing sites. *Journal of Phycology* 27:642–648.
- Faust, M. A. 1992. Observations on the morphology and sexual reproduction of *Coolia monotis* (Dinophyceae). *Journal of Phycology* 28:94–104.
- Faust, M. A. 1993a. *Prorocentrum belizeanum*, *Prorocentrum elegans* and *Prorocentrum caribbaeum*, three new benthic species (Dinophyceae) from a mangrove island Twin Cays, Belize. *Journal of Phycology* 29:100–107.

- Faust, M. A. 1993b. Surface morphology of the marine dinoflagellate *Sinophysis microcephalus* (Dinophyceae) from a mangrove island, Twin Cays, Belize. *Journal of Phycology* 29:355–363.
- Faust, M. A. 1993c. Three new benthic species of *Prorocentrum* (Dinophyceae) from Twin Cays, Belize: *P. maculosum* sp. nov., *P. foraminosum* sp. nov. and *P. formosum* sp. nov. *Phycologia* 32:410–418.
- Faust, M. A. 1994. Three new benthic species of *Prorocentrum* (Dinophyceae) from Carrie Bow Cay, Belize; *P. sabulosum* sp. nov., *P. sculptile* sp. nov., and *P. arenarium* sp. nov. *Journal of Phycology* 30:755–763.
- Faust, M. A., & Balech, E. 1993. A further SEM study of marine benthic dinoflagellates from a mangrove island, Twin Cays, Belize including *Plagiodinium belizeanum* gen. et sp. nov. *Journal of Phycology* 29:826–832.
- Fensome, R. A., Taylor, F. J. R., Norris, G., Sarjeant, W. A. S., Wharton, D. I., & Williams, G. L. 1993. “A Classification of Living and Fossil Dinoflagellates,” pp. 351. Sheridan Press, Hanover, PA.
- Fott, B. 1957. Taxonomie drobnohledne flory nasich vod. *Preslia* 29:278–319.
- Francis, D. 1967. On the eyespot of the dinoflagellate *Nematodinium*. *Journal of Experimental Biology* 47:495–501.
- Fritz, L., & Triemer, R. E. 1985. A rapid simple technique utilizing Calcofluor White M2R for the visualization of dinoflagellate thecal plates. *Journal of Phycology* 21:662–664.
- Freudenthal, H. D. 1962. *Symbiodinium* gen. nov. and *Symbiodinium microadriaticum* sp. nov., a zooxanthella: taxonomy, life cycle, and morphology. *Journal of Protozoology* 9:45–52.
- Fukuyo, Y. 1981a. *Protogonyaulax* in the coast of Japan. *Akashiwo Kenkyukai Guide Book* 3:1–72.
- Fukuyo, Y. 1981b. Taxonomical study on benthic dinoflagellates collected in coral reefs. *Bulletin of the Japanese Society of Scientific Fisheries* 47:967–978.
- Fukuyo, Y., Takano, H., Chihara, M., & Matsuoka, K. (eds.) 1990. “Red Tide Organisms in Japan—An Illustrated Taxonomic Guide,” pp. 407. Uchida Rokakuho, Tokyo.
- Gaarder, K. R. 1954. Dinoflagellatae from the “Michael Sars” North Atlantic deep-sea expedition 1910. *Scientific Research Report of the “Michael Sars” North Atlantic Deep-Sea Expedition 1910* 2:1–62.
- Gaines, G., & Elbrächter, M. 1987. Heterotrophic nutrition. In “The Biology of Dinoflagellates” (F. J. R. Taylor, ed.), Botanical Monographs No. 21, pp. 224–268. Blackwell, Oxford.
- Gao, X., & Dodge, J. D. 1991. The taxonomy and ultrastructure of a marine dinoflagellate, *Scrippsiella minima* sp. nov. *British Phycological Journal* 26:21–31.
- Gao, X., Dodge, J. D., & Lewis, J. 1989a. An ultrastructural study of planozygotes and encystment of a marine dinoflagellate *Scrippsiella* sp. *British Phycological Journal* 24:153–165.
- Gao, X., Dodge, J. D., & Lewis, J. 1989b. Gamete fusion and mating in the marine dinoflagellate *Scrippsiella* sp. *Phycologia* 28:342–351.
- Gardiner, W. E., Rushing, A. E., & Dawes, C. J. 1989. Ultrastructural observations of *Gyrodinium estuariale* (Dinophyceae). *Journal of Phycology* 25:178–183.
- Gocht, H. 1981. »Direkter« nachweis der plattenuberlappung bei *Hystrichogonyaulax cladophora* (Dinoflagellata, Oberjura). *Neues Jahrbuch für Geologie und Palaeontologie Monatshefte* 3:149–156.
- Gocht, H., & Netzel, H. 1974. Rasterelektronenmikroskopische Untersuchungen am Panzer von *Peridinium* (Dinoflagellata). *Archiv für Protistenkunde* 116:381–410.
- Graham, H. W. 1942. Studies on the morphology, taxonomy, and ecology of the Peridinales. *Carnegie Institution of Washington Publication* 542.
- Graham, H. W., & Bronnikovsky, N. 1944. The genus *Ceratium* in the Pacific and North Atlantic Oceans. *Carnegie Institution of Washington Publication* 565 5:1–209.
- Guillard, R. R. L., & Keller, M. D. 1984. Culturing dinoflagellates. In “Dinoflagellates” (D. L. Spector, ed.), pp. 391–442. Academic Press, Orlando.

- Halim, Y. 1960a. *Alexandrium minutum*, n. gen. n. sp. dinoflagelle provocant des eaux rouges. *Vie Milieu* 11:102–105.
- Halim, Y. 1960b. Etude quantitative et qualitative du cycle ecologique des dinoflagelles dans les eaux de Villefranche-sur-mer. *Annales de l'Institut Oceanographique* 38:1–232.
- Hallegraeff, G. M. 1991. "Aquaculturists' Guide to Harmful Australian Microalgae." CSIRO Division of Fisheries, Tasmania, Australia.
- Hallegraeff, G. M., & Lucas, I. A. N. 1988. The marine dinoflagellate genus *Dinophysis* (Dinophyceae): Photosynthetic, neritic and non-photosynthetic, oceanic species. *Phycologia* 27:25–42.
- Hallegraeff, G. M., Steffensen, D. A., & Wetherbee, R. 1988. Three estuarine Australian dinoflagellates that can produce paralytic shellfish toxins. *Journal of Plankton Research* 10:533–541.
- Hansen, G. 1989. Ultrastructure and morphogenesis of scales in *Katodinium rotundatum* (Lohmann) Loeblich (Dinophyceae). *Phycologia* 28:385–394.
- Hansen, G. 1993. Light and electron microscopical observations of the dinoflagellate *Actiniscus pentasterias* (Dinophyceae). *Journal of Phycology* 29:486–499.
- Harland, R. 1981. Cysts of the colonial dinoflagellate *Polykrikos schwartzii* Bütschli 1873, (Gymnodiniales), from recent sediments, Firth of Forth, Scotland. *Palynology* 5:65–79.
- Hasle, G. R., & Nordli, E. 1951. Form variation in *Ceratium fusus* and *tripos* populations in cultures and from the sea. *Avhandlingar Utgitt av det Norske Videnskaps Akademi i Oslo Matematisk - Naturvidenskapelig Klasse* 4:1–25.
- Herdman, E. C. 1922. Notes on dinoflagellates and other organisms causing discoloration of the sand at Port Erin. II. *Transactions of the Liverpool Biological Society* 36:15–30.
- Honsell, G., & Cabrini, M. 1991. *Scrippsiella spinifera* sp. nov. (Pyrrhophyta): A new dinoflagellate from the northern Adriatic Sea. *Botanica Marina* 34:167–175.
- Honsell, G., & Talarico, L. 1985. The importance of flagellar arrangement and insertion in the interpretation of the theca of *Prorocentrum* (Dinophyceae). *Botanica Marina* 28:15–21.
- Horiguchi, T., & Chihara, M. 1987. *Spiniferodinium galeiforme*, new genus new species of benthic dinoflagellates, Phytodiniales, Pyrrhophyta, from Japan. *Phycologia* 26:478–487.
- Horiguchi, T., & Pienaar, R. N. 1988. Ultrastructure of a new sand-dwelling dinoflagellate, *Scrippsiella arenicola*, new species. *Journal of Phycology* 24:426–438.
- Horiguchi, T., & Pienaar, R. N. 1991. Ultrastructure of a marine dinoflagellate, *Peridinium quinquecorne* Abé (Peridinales) from South Africa with particular reference to its chrysophyte endosymbiont. *Botanica Marina* 34:123–131.
- Hulburt, E. M. 1957. The taxonomy of unarmored Dinophyceae of shallow embayments on Cape Cod, Massachusetts. *Biological Bulletin* 112:196–219.
- Hulburt, E. M. 1965. Three closely allied dinoflagellates. *Journal of Phycology* 1:95–96.
- Indelicato, S. R., & Loeblich, A. R., III. 1985. A description of the marine dinoflagellate, *Scrippsiella tinctoria* sp. nov. *Japanese Journal of Phycology* 33:127–134.
- Indelicato, S. R., & Loeblich, A. R., III. 1986. A revision of the marine peridinioid genera (Pyrrhophyta) utilizing hypothecal-cingular plate relationships as a taxonomic guide. *Japanese Journal of Phycology* 34:153–162.
- Inouye, I., & Pienaar, R. N. 1983. Observations on the life cycle and microanatomy of *Thoracosphaera heimii* (Dinophyceae) with special reference to its systematic position. *South African Journal of Botany* 2:63–75.
- Javornicky, P. 1962. Two scarcely known genera of the class Dinophyceae: *Bernardinium* Chodat and *Crypthecodinium* Biecheler. *Preslia* 34:98–113.
- Jianfan, W., & Jingyan, L. 1992. The nucleoskeleton of special dinoflagellate, *Oxyrrhis marina*. *Zoological Research* 13:89–94.
- Jørgensen, E. 1911. Die Ceratien. Eine kurze monographie der gattung *Ceratium* Schrank. *Internationale Revue der Gesamten Hydrobiologie und Hydrographie* 4:1–124.
- Jørgensen, E. 1920. Mediterranean ceratia. *Report of the Danish Oceanographic Expedition in the Mediterranean*, 2 (Biology) 1:1–110.

- Kimball, J. F., Jr., & Wood, E. J. F. 1965. A dinoflagellate with characters of *Gymnodinium* and *Gyrodinium*. *Journal of Protozoology* 12:577–580.
- Kimor, B. 1981. The role of phagotrophic dinoflagellates in marine ecosystems. *Kieler Meeresforche Sonderh* 5:164–173.
- Kita, T., & Fukuyo, Y. 1988. Description of the gonyaulacoid dinoflagellate *Alexandrium hiranoi* sp. nov. inhabiting tidepools on Japanese Pacific coast. *Bulletin of the Plankton Society of Japan* 35:1–7.
- Klut, M. E., Bisalputra, T., & Antia, N. J. 1985. Some cytochemical studies on the cell surface of *Amphidinium carterae* (Dinophyceae). *Protoplasma* 129:93–99.
- Klut, M. E., Bisalputra, T., & Antia, N. J. 1988. The use of fluorochromes in the cytochemical characterization of some phytoflagellates. *Histochemical Journal* 20:35–40.
- Kofoid, C. A. 1906a. Dinoflagellata of the San Diego region. I: On *Heterodinium* a new genus of the Peridinidae. *University of California Publications in Zoology* 2:341–368.
- Kofoid, C. A. 1906b. Dinoflagellata of the San Diego region. II. On *Triposolenia* a new genus of the Dinophysidae. *University of California Publications in Zoology* 3:93–116.
- Kofoid, C. A. 1907a. Dinoflagellata of the San Diego region. III. Descriptions of new species. *University of California Publications in Zoology* 3:299–340.
- Kofoid, C. A. 1907b. Reports of the scientific results of the expedition to the eastern tropical Pacific in charge of Alexander Agassiz, 9. New species of dinoflagellates. *Bulletin of the Museum of Comparative Zoology at Harvard College* 50:163–207.
- Kofoid, C. A. 1909. On *Peridinium steinii* Jørgensen, with a note on the nomenclature of the skeleton of Peridinidae. *Archiv fur Protistenkunde* 16:25–47.
- Kofoid, C. A. 1910. A revision of the genus *Ceratocorys* based on skeletal morphology. *University of California Publications in Zoology* 6:177–187.
- Kofoid, C. A. 1911a. Dinoflagellata of the San Diego region. IV. The genus *Gonyaulax*, with notes on its skeletal morphology and a discussion of its generic and specific characters. *University of California Publications in Zoology* 8:187–286.
- Kofoid, C. A. 1911b. On the skeletal morphology of *Gonyaulax catenata*. *University of California Publications in Zoology* 8:287–294.
- Kofoid, C. A. 1911c. Dinoflagellata of the San Diego region, V: *Spiraulax*, a new genus of the Peridinida. *University of California Publications in Zoology* 8:295–300.
- Kofoid, C. A. 1926. On *Oxyphysis oxytoxoides* gen. nov., sp. nov. A dinophysoid dinoflagellate convergent toward the peridinioid type. *University of California Publications in Zoology* 28:203–216.
- Kofoid, C. A., & Adamson, A. M. 1933. The Dinoflagellata: The family Heterodiniidae of the Peridinoidae. *Memoirs of the Museum of Comparative Zoology, Harvard* 54:1–136.
- Kofoid, C. A., & Michener, J. R. 1911. Reports of the scientific results of the expedition to the eastern tropical Pacific in charge of Alexander Agassiz, 22. New genera and species of dinoflagellates. *Bulletin of the Museum of Comparative Zoology at Harvard College* 54:267–302.
- Kofoid, C. A., & Skogsberg, T. 1928. The Dinoflagellata: The Dinophysoidae. *Memoirs of the Museum of Comparative Zoology, Harvard* 51:13–760.
- Kofoid, C. A., & Swezy, O. 1921. The free-living unarmored dinoflagellates. *Memoirs of the University of California* 5:1–562.
- Kubai, D. F., & Ris, H. 1969. Division in the dinoflagellate *Gyrodinium cohnii* (Schiller). A new type of nuclear reproduction. *Journal of Cell Biology* 40:508–528.
- Lackey, J. B. 1956. Known geographic range of *Gymnodinium brevis* Davis. *Quarterly Journal of the Florida Academy of Sciences* 19:71.
- Landsberg, J. H., Steidinger, K. A., Blakesley, B. A., & Zondervan, R. L. 1994. Scanning electron microscope study of dinospores of *Amyloodinium* cf. *ocellatum*, a pathogenic dinoflagellate parasite of marine fish, and comments on its relationship to the Peridiniales. *Diseases of Aquatic Organisms* 20:23–32.

- Landsberg, J. H., Steidinger, K. A., & Blakesley, B. A. 1995. Fish-killing dinoflagellates in a tropical marine aquarium. In "Harmful Marine Algal Blooms" (P. Lassus, G. Arzul, E. Erard, P. Gentien, & C. Marcaillou, eds.), pp. 65–70. Lavoisier Cahen Cedex, France.
- Larsen, J. 1985. Algal studies of the Danish Wadden Sea. II. A taxonomic study of psammobious dinoflagellates. *Opera Botanica* 79:14–37.
- Larsen, J. 1988. An ultrastructural study of *Amphidinium poecilochroum* (Dinophyceae), a phagotrophic dinoflagellate feeding on small species of cryptophytes. *Phycologia* 27:366–377.
- Larsen, J. 1994. Unarmored dinoflagellates from Australian waters I. The genus *Gymnodinium* (Gymnodiniales, Dinophyceae). *Phycologia* 33:24–33.
- Larsen, J., & Moestrup, Ø. 1989. "Guide to Toxic and Potentially Toxic Marine Algae," pp. 61. The Fish Inspection Service, Ministry of Fisheries, Copenhagen.
- Larsen, J., & Sournia, A. 1991. The diversity of heterotrophic dinoflagellates. In "The Biology of Free-Living Heterotrophic Flagellates" (D. J. Patterson & J. Larsen, eds.), pp. 313–332. Clarendon Press, Oxford.
- Lebour, M. V. 1925. "The Dinoflagellates of the Northern Seas," pp. 250. Marine Biological Association of the United Kingdom, Plymouth, UK.
- Levandowsky, M., & Kaneta, P. J. Behaviour in dinoflagellates. In "The Biology of Dinoflagellates" (F. J. R. Taylor, ed.), Botanical Monographs Vol. 21, pp. 360–397. Blackwell Oxford.
- Lewis, J. 1990. The cyst–theca relationship of *Oblea rotunda* (Diplopsalidaceae, Dinophyceae). *British Phycological Journal* 25:339–351.
- Lewis, J. 1991. Cyst–theca relationships in *Scrippsiella* (Dinophyceae) and related orthoperidinioid genera. *Botanica Marina* 34:91–106.
- Lewis, J., Dodge, J. D., & Tett, P. 1984. Cyst–theca relationships in some *Protoperidinium* species (Peridinales) from Scottish sea lochs. *Journal of Micropalaeontology* 3:25–34.
- Loeblich, A. R., III. 1965. Dinoflagellate nomenclature. *Taxon* 14:15–18.
- Loeblich, A. R., III. 1968. A new marine dinoflagellate genus *Cachonina* in axenic culture from the Salton Sea, California, with remarks on the genus *Peridinium*. *Proceedings of the Biological Society of Washington* 81:91–96.
- Loeblich, A. R., III. 1976. Dinoflagellate evolution: Speculation and evidence. *Journal of Protozoology* 23:111–128.
- Loeblich, A. R., III. 1982. Dinophyceae. In "Synopsis and Classification of Living Organisms" (S. P. Parker, ed.), Vol. 1, pp. 101–115. McGraw–Hill, New York.
- Loeblich, A. R., III, & Loeblich, L. A. 1985. Dinoflagellates: Structure of the amphiesma and re-analysis of thecal plate patterns. *Hydrobiologia* 123:177–180.
- Loeblich, A. R., III, & Sherley, J. L. 1979. Observations on the theca of the motile phase of free living and symbiotic isolates of *Zooxanthella microadriatica* new combination. *Journal of the Marine Biological Association of the United Kingdom* 59:195–206.
- Loeblich, A. R., III, Sherley, J. L., & Schmidt, R. J. 1979. The correct position of flagellar insertion in *Prorocentrum* and description of *P. rathymum* sp. nov. (Pyrrhophyta). *Journal of Plankton Research* 1:113–120.
- Loeblich, A. R., III, Schmidt, R. J., & Sherley, J. L. 1981. Scanning electron microscopy of *Heterocapsa pygmaea* sp. nov., and evidence for polyploidy as a speciation mechanism in dinoflagellates. *Journal of Plankton Research* 3:67–79.
- Loeblich, A. R., Jr., & Loeblich, A. R., III. 1966. Index to the genera, subgenera, and sections of the Pyrrhophyta. In "Studies in Tropical Oceanography," Vol. 3, pp. 94. University of Miami, Institute of Marine Science, Miami.
- Loeblich, A. R., Jr., & Loeblich, A. R., III. 1969. Index to the genera, subgenera, and sections of the Pyrrhophyta, III. *Journal of Paleontology* 43:193–198.
- Loper, C. L., Steidinger, K. A., & Walker, L. M. 1980. A simple chromosome spread technique for unarmored dinoflagellates and implications of polyploidy in algal cultures. *Transactions of the American Microscopical Society* 99:343–346.



- López, J. 1966. Variación y regulación de la forma en el género *Ceratium*. *Investigación Pesquera* 30:325–427.
- MacKenzie, L. 1992. Does *Dinophysis* (Dinophyceae) have a sexual life cycle. *Journal of Phycology* 28:399–406.
- Martin, G. W. 1929. Dinoflagellates from marine and brackish waters of New Jersey. *University of Iowa Studies in Natural History* 12:1–32.
- Matsuoka, K. 1985. Cyst and thecate forms of *Pyrophacus steinii* (Schiller) Wall et Dale, 1971. *Transactions of the Proceedings of the Palaeontological Society of Japan, N. S.* 140:240–262.
- Matsuoka, K. 1988. Cyst–theca relationships in the Diplopsalid group (Peridinales, Dinophyceae). *Review of Palaeobotany and Palynology* 56:95–122.
- Matsuoka, K., & Fukuyo, Y. 1986. Cyst and motile morphology of colonial dinoflagellate *Pheopolykrikos hartmannii* (Zimmermann) comb. nov. *Journal of Plankton Research* 8:811–818.
- Matsuoka, K., Fukuyo, Y., & Anderson, D. M. 1989. Methods for modern dinoflagellate cyst studies. In “Red Tides: Biology, Environmental Science, and Toxicology” (T. Okaichi, D. M. Anderson, & T. Nemato, eds.), pp. 461–479. Elsevier, New York.
- Matsuoka, K., Kobayashi, S., & Gaines, G. 1990. A new species of the genus *Ensiculifera* (Dinophyceae); Its cyst and motile forms. *Bulletin of Plankton Society of Japan* 37:127–143.
- Montresor, M., & Zingone, A. 1988. *Scrippsiella precaria* sp. nov. (Dinophyceae), a marine dinoflagellate from the Gulf of Naples. *Phycologia* 27:387–394.
- Montresor, M., Zingone, A., & Marino, D. 1993. The calcareous resting cyst of *Pentapharsodinium tyrrhenicum* comb. nov. (Dinophyceae). *Journal of Phycology* 29:223–230.
- Morey-Gaines, G., & Ruse R. H. 1980. Encystment and reproduction of the predatory dinoflagellate, *Polykrikos kofoidii* Chatton (Gymnodinales). *Phycologia* 19:230–232.
- Mornin, L., & Francis, D. 1967. The fine structure of *Nematodinium armatum*, a naked dinoflagellate. *Journal of Microscopy* 6:759–772.
- Morrill, L. C., & Loeblich, A. R., III. 1981a. A survey for body scales in dinoflagellates and a revision of *Cachonina* and *Heterocapsa* (Pyrrhophyta). *Journal of Plankton Research* 3:53–65.
- Morrill, L. C., & Loeblich, A. R., III. 1981b. The dinoflagellate pellicular wall layer and its occurrence in the division Pyrrhophyta. *Journal of Phycology* 17:315–323.
- Morrill, L. C., & Loeblich, A. R., III. 1983. Formation and release of body scales in the dinoflagellate genus *Heterocapsa*. *Journal of Marine Biological Association of the United Kingdom* 63:905–913.
- Neeham, G. H. 1977. “The Practical Use of the Microscope Including Photomicrography,” pp. 493. C. C. Thomas, Springfield, IL.
- Nie, D. 1939. Dinoflagellata of the Hainan region. II. On the thecal morphology of *Blepharocysta*, with a description of a new species. *Contributions of the Biological Laboratory of the Science Society of China, Zoological Series* 13:23–39.
- Nie, D. 1942. Dinoflagellata of the Hainan region. IV. On the thecal morphology of *Podolampas* with description of species. *Sinensia* 13:53–60.
- Nie, D., & Wang, C. 1944. Dinoflagellata of the Hainan region. VIII. On *Sinophysis microcephalus*, a new genus and species of Dinophysidae. *Sinensia* 15:145–151.
- Nordli, E. 1957. Experimental studies in the ecology of Ceratia. *Oikos* 8:200–265.
- Norris, D. R. 1969. Thecal morphology of *Ornithocercus magnificus* (Dinoflagellata) with notes on related species. *Bulletin of Marine Science* 19:175–193.
- Norris, D. R., & Berner, L. D., Jr. 1970. Thecal morphology of selected species of *Dinophysis* (Dinoflagellata) from the Gulf of Mexico. *Contributions in Marine Science* 15:145–192.
- Norris, D. R., Bomber, J. W., & Balech, E. 1985. Benthic dinoflagellates associated with ciguatera from the Florida Keys. I. *Ostreopsis heptagona* sp. nov. In “Toxic Dinoflagellates” (D. M. Anderson, A. W. White, & D. G. Baden, eds.) pp. 39–44. Elsevier, New York.
- Palincsar, J. S., Jones, W. R., & Palincsar, E. E. 1988. Effects of isolation of the endosymbiont *Symbiodinium microadriaticum* (Dinophyceae) from its host *Aiptasia pallida* (Anthozoa)

- on cell wall ultrastructure and mitotic rate. *Transactions of the American Microscopical Society* 107:53–66.
- Pfiester, L. A., & Anderson, D. M. 1987. Dinoflagellate reproduction. In “The Biology of Dinoflagellates” (F. J. R. Taylor, ed.), Botanical Monographs Vol. 21, pp. 611–648. Blackwell, Oxford.
- Pfiester, L. A., & Holt, J. R. 1982. A technique for counting chromosomes of armored dinoflagellates, and chromosome numbers of six freshwater dinoflagellate species. *American Journal of Botany* 69:1165–1168.
- Pincemin, J. M., & Gayol, P. 1978. Naked and thecate swarmer in clonal *Pyrocystis fusiformis*: Systematic and physiology problems. *Archiv fur Protistenkunde* 120:401–408.
- Pincemin, J. M., Gayol, P., & Salvano, P. 1981. Observations on the thecate stage of the dinoflagellate *Pyrocystis* cf. *fusiformis* (clones NOB2 and 111): Variations in morphology and tabulation. *Archiv fur Protistenkunde* 124:271–282.
- Pincemin, J. M., Gayol, P., & Salvano, P. 1982. *Pyrocystis lunula*: Dinococcide giving rise to a biflagellated thecate stage. *Archiv fur Protistenkunde* 125: 95–107.
- Pomroy, A. J. 1989. Scanning electron microscopy of *Heterocapsa minima* sp. nov. (Dinophyceae) and its seasonal distribution in the Celtic Sea. *British Phycological Journal* 24:131–135.
- Popovský, J., & Pfiester, L. A. 1990. Dinophyceae (Dinoflagellida). In “Süßwasserflora von Mitteleuropa” (H. Ertl, J. Gerloff, H. Heynig, & D. Mollerhauer, eds.), Brgründet von A. Pascher, Band 6, pp. 272. Gustav Fischer Verlag, Jena Stuttgart.
- Posek, M. T., Johnson, A. H., & McMichael, K. L. 1980. “Scanning Electron Microscopy. A Student’s Handbook,” pp. 305. Ladd Research Industries, Inc.
- Rampi, L., & Bernhard, M. 1980. “Chiave per la Determinazione delle Peridinee Pelagiche Mediterranee,” pp. 193. Comitato Nazionale Energia Nucleare CNEN-RT/B10(80)8.
- Reinecke, P. 1967. *Gonyaulax grindleyi* sp. nov.: A dinoflagellate causing a red tide at Elands Bay, Cape Province, in December 1966. *Journal of South African Botany* 33:157–160.
- Rizzo, P. J. 1987. Biochemistry of the dinoflagellate nucleus. In “The Biology of Dinoflagellates” (F. J. R. Taylor, ed.), Botanical Monographs Vol. 21, pp. 143–173. Blackwell, Oxford.
- Roberts, K. R., & Timpano, P. 1989. Comparative analyses of the dinoflagellate flagellar apparatus. 1. *Woloszynskia* sp. *Journal of Phycology* 25:26–36.
- Roberts, K. R., Farmer, M. A., Schneider, R. M., & Lemoine, J. E. 1988. The microtubular cytoskeleton of *Amphidinium rhinocephalum* (Dinophyceae). *Journal of Phycology* 24: 544–553.
- Rowan, R., & Powers, D. A. 1991. A molecular genetic classification of zooxanthellae and the evolution of animal–algal symbioses. *Science* 251:1348–1351.
- Saunders, R. D., & Dodge J. D. 1984. An SEM study and taxonomic revision of some armoured sand-dwelling marine dinoflagellates. *Protistologica* 20:271–283.
- Schiller, J. 1933. Dinoflagellatae (Peridineae) in monographischer Behandlung. I. Teil, Lieferung 3. In “Dr. L. Rabenhorst’s Kryptogamen-Flora von Deutschland, Österreich und der Schweiz,” pp. 617. Akademische Verlagsgesellschaft, Leipzig.
- Schiller, J. 1937. Dinoflagellatae (Peridineae) in monographischer Behandlung. 2. Teil, Lieferung 4. In “Dr. L. Rabenhorst’s Kryptogamen-Flora von Deutschland, Österreich und der Schweiz.” pp. 589. Akademische Verlagsgesellschaft, Leipzig.
- Schmidt, R. J., & Loeblich, A. R., III. 1979. Distribution of paralytic shellfish poisoning among Pyrrophyta. *Journal of the Marine Biological Association of the United Kingdom* 59:479–487.
- Schoenberg, D. A., & Trench, R. K. 1980. Genetic variation in *Symbiodinium* (= *Gymnodinium*) *microadriaticum* Freudenthal, and specificity in its symbiosis with marine invertebrates. II. Morphological variation in *S. microadriaticum*. *Proceedings of the Royal Society of London (B)* 207:429–444.
- Silva, P. C. 1960. Remarks on algal nomenclature, III. *Taxon* 9:18–25.
- Sournia, A. 1967a. Contribution a la connaissance des peridiniens microplanctoniques du Canal de Mozambique. *Bulletin du Musee National d’Histoire Naturelle* 39:417–438.

- Sournia, A. 1967b. Le genre *Ceratium* (peridinien planctonique) dans le canal de Mozambique contribution a une revision mondiale. *Vie Milieu* 18:375–500.
- Sournia, A. 1972. Une periode de pousses phytoplantoniques pres de Nosy-be (Madagascar) en 1971. I. Especies rares ou nouvelles du phytoplanton. *Cahiers ORSTOM, Serie Oceanographique* 10:151–159.
- Sournia, A. 1978. Phytoplankton manual. “Monographs on *Oceanographic Methodology*,” No. 6, pp. 337. UNESCO. Paris.
- Sournia, A. 1986. “Atlas du Phytoplankton Marin. Volume I: Introduction, Cyanophycées, Dictyochophycées, Dinophycées et Raphidophycées,” pp. 219. Editions du Centre National de la Recherche Scientifique, Paris.
- Soyer, M.-O. 1970. Les ultrastructures liées aux fonctions de relation chez *Noctiluca miliaris* S. (Dinoflagellata). *Zeitschrift Zellforsch* 104:29–55.
- Spector, D. L. (ed.) 1984. “Dinoflagellates,” pp. 545. Academic Press, Orlando.
- Spero, H. J., & Moree, M. 1981. Phagotrophic feeding and its importance to the life cycle of the holozoic dinoflagellate, *Gymnodinium fungiforme*. *Journal of Phycology* 17:43–51.
- Spero, H. J. 1982. Phagotrophy in *Gymnodinium fungiforme* (Pyrrhophyta): The peduncle as an organelle of ingestion. *Journal of Phycology* 18:356–360.
- Steidinger, K. A. 1968. The genus *Gonyaulax* in Florida waters. I. Morphology and thecal development in *Gonyaulax polygramma* Stein, 1883. *Florida Board of Conservation, Division of Salt Water Fisheries, Marine Laboratory, Leaflet Series* 1:1–5.
- Steidinger, K. A. 1971. *Gonyaulax balechii* sp. nov. (Dinophyceae) with a discussion of the genera *Gonyaulax* and *Heteraulacus*. *Phycologia* 10:183–187.
- Steidinger, K. A. 1979. Collection, enumeration and identification of free-living marine dinoflagellates. In “Toxic Dinoflagellate Blooms” (D. L. Taylor and H. H. Seliger, eds.), pp. 435–442. Elsevier, New York.
- Steidinger, K. A. 1983. A re-evaluation of toxic dinoflagellate biology and ecology. In “Progress in Phycological Research” (F. E. Round & D. J. Chapman, eds.), pp. 147–188. Elsevier, New York.
- Steidinger, K. A. 1990. Species of the *tamarensis/catenella* group of *Gonyaulax* and the fucoxanthin derivative-containing gymnodinioids. In “Toxic Marine Phytoplankton” (E. Graneli, B. Sundstrom, L. Edler, & D. M. Anderson, eds.), pp. 11–16. Elsevier, New York.
- Steidinger, K. A. 1993. Some taxonomic and biologic aspects of toxic dinoflagellates. In “Algal Toxins in Seafood and Drinking Water” (I. R. Falconer, ed.), pp. 1–28. Academic Press, London.
- Steidinger, K. A., Babcock, C., Mahmoudi, B., Tomas, C., & Truby, E. 1989. Conservative taxonomic characters in toxic dinoflagellate species identification. In “Red Tides: Biology, Environmental Science, and Toxicology” (T. Okaichi, D. M. Anderson, & T. Nemoto, eds.), pp. 285–288. Elsevier, New York.
- Steidinger, K. A., Burkholder, J. A., Glasgow, H. B., Jr., Hobbs, C. W., Garrett, J. K., Truby, E. W., Noga, E. J., & Smith, S. A. 1996. *Pfiesteria piscicida*, gen. et sp. nov. (Pfiesteriaceae, fam. nov., Dinophyceae), a new dinoflagellate with a complex life cycle and behavior. Submitted for publication.
- Steidinger, K. A., Truby, E. W., Garrett, J. K., & Burkholder, J. M. 1995. The morphology and cytology of a newly discovered toxic dinoflagellate. In “Harmful Marine Algal Blooms” (P. Lassus, G. Arzul, E. Erard, P. Gentien, & C. Marcaillou, eds.), pp. 83–88. Lavoisier, Cachan Cedex, France.
- Steidinger, K. A., & Balech, E. 1977. *Scrippsiella subsalsa* (Ostenfield) comb. nov. (Dinophyceae) with a discussion on *Scrippsiella*. *Phycologia* 16:69–73.
- Steidinger, K. A., & Cox, E. R. 1980. Free-living dinoflagellates. In “Phytoflagellates” (E. R. Cox, ed.), pp. 407–432. Elsevier/North Holland, New York.
- Steidinger, K. A., & Davis, J. T. 1967. The genus *Pyrophacus*, with a description of a new form. *Florida Board of Conservation Marine Laboratory Leaflet Series* 1:1–8.
- Steidinger, K. A., & Moestrup, Ø. 1990. The taxonomy of *Gonyaulax*, *Pyrodinium*, *Alexandrium*, *Gessnerium*, *Protogonyaulax*, and *Goniodoma*. In “Toxic Marine Phytoplankton” (E. Graneli, B. Sundstrom, L. Edler, & D. M. Anderson, eds.), pp. 522–523. Elsevier, New York.

- Steidinger, K. A., & Vargo, G. A. 1988. Marine dinoflagellate blooms: Dynamics and impacts. In "Algae and Human Affairs" (C. A. Lembi & J. R. Waaland, eds.), pp. 373–401. Cambridge University Press, Cambridge.
- Steidinger, K. A., & Williams, J. 1970. Dinoflagellates. "Memoirs of the Hourglass Cruises," Vol. 2, pp. 251. Florida Department of Natural Resources Marine Research Laboratory, St. Petersburg, FL.
- Subrahmanyam, R. 1966. New species of Dinophyceae from Indian waters. I. The genera *Haplodinium* Klebs emend. Subrahmanyam and *Mesoporos* Lillick. *Phykos* 5:175–180.
- Subrahmanyam, R. 1968. "The Dinophyceae of the Indian Seas. Part 1. Genus *Ceratium* Schrank," pp. 118. Marine Biological Association of India, Memoir II.
- Subrahmanyam, R. 1971. "The Dinophyceae of the Indian Seas. Part 2. Family Peridiniaceae Schütt emend. Lindemann," pp. 334. Marine Biological Association of India, Memoir II.
- Sweeney, B. M. 1978. Ultrastructure of *Noctiluca miliaris* (Pyrrhopyhta) with green flagellate symbionts. *Journal of Phycology* 14:116–120.
- Swift, E., & Durbin, E. G. 1971. Similarities in the asexual reproduction of the oceanic dinoflagellates, *Pyrocystis fusiformis*, *Pyrocystis lunula*, and *Pyrocystis noctiluca*. *Journal of Phycology* 7:89–96.
- Swift, E., & Wall, D. 1972. Asexual reproduction through a thecate stage in *Pyrocystis acuta* Kofoid, 1907 (Dinophyceae). *Phycologia* 11:57–65.
- Tafall, B. F. O. 1942. Notas sobre algunos dinoflagelados planctonicos marinos de Mexico, con descripcion de nuevas especies. *Anales de la Escuela Nacional de Ciencias Biologicas* 2:435–447.
- Tai, L., & Skosberg T. 1934. Studies on the Dinophysoidae, marine armored dinoflagellates of Monterey Bay, California. *Archiv fur Protistenkunde* 82:380–482.
- Takayama, H., & Adachi, R. 1984. *Gymnodinium nagasakiense* sp. nov., a red-tide forming dinophyte in the adjacent waters of Japan. *Bulletin of the Plankton Society of Japan* 31:7–14.
- Takayama, H. 1985. Apical grooves of unarmored dinoflagellates. *Bulletin of Plankton Society of Japan* 32:129–140.
- Tangen, K., Brand, L. E., Blackwelder, P. L., & Guillard, R. R. L. 1982. *Thoracosphaera heimii* (Lohmann) Kämtner is a dinophyte: Observations on its morphology and life cycle. *Marine Micropaleontology* 7:193–212.
- Taylor, D. L. 1971a. Taxonomy of some common *Amphidinium* species. *British Phycological Journal* 6:129–133.
- Taylor, D. L. 1971b. Ultrastructure of the "zooxanthella," *Endodinium chattonii* in situ. *Journal of the Marine Biological Association of the United Kingdom* 51:227–234.
- Taylor, F. J. R. 1963. *Brachydidinium*, a new genus of the Dinococcales from the Indian Ocean. *Journal of South African Botany* 29:75–78.
- Taylor, F. J. R. 1971. Scanning electron microscopy of thecae of the dinoflagellate genus *Ornithocercus*. *Journal of Phycology* 9:1–10.
- Taylor, F. J. R. 1972. Unpublished observations on the thecate stage of the dinoflagellate genus *Pyrocystis* by the late C. A. Kofoid and Josephine Michener. *Phycologia* 11:47–55.
- Taylor, F. J. R. 1973. Topography of cell division in the structurally complex dinoflagellate genus *Ornithocercus*. *Journal of Phycology* 9:1–10.
- Taylor, F. J. R. 1975. Taxonomic difficulties in red tide and paralytic shellfish poison studies: the "Tamarensis complex" of *Gonyaulax*. *Environmental Letters* 9:103–119.
- Taylor, F. J. R. 1976. Dinoflagellates from the International Indian Ocean Expedition. *Bibliotheca Botanica* 132:1–234.
- Taylor, F. J. R. 1979. The toxigenic gonyaulacoid dinoflagellates. In "Toxic Dinoflagellate Blooms" (D. L. Taylor & H. H. Seliger, eds.), pp. 47–56. Elsevier/North Holland, New York.
- Taylor, F. J. R. 1980. On dinoflagellate evolution. *Biosystems* 13:65–108.
- Taylor, F. J. R. 1984. Toxic dinoflagellates: taxonomic and biogeographic aspects with emphasis on *Protogonyaulax*. In "Seafood Toxins" (E. P. Ragelis, ed.), pp. 77–97. American Chemical Society, Washington, DC.

- Taylor, F. J. R. (ed.) 1987. "The Biology of Dinoflagellates," pp. 705. Blackwell, Oxford.
- Thompson, R. H. 1950. A new genus and new records of freshwater Pyrrhophyta in the Desmomonadales and Dinophyceae. *Lloydia* 13:277–299.
- Thronsen, J. 1993. The planktonic marine flagellates. In "Marine Phytoplankton: A Guide to Naked Flagellates and Coccolithophorids" (C. R. Tomas, ed.) pp. 7–146. Academic Press, San Diego.
- Toriumi, S., & Dodge, J. D. 1993. Thecal apex structure in the Peridiniaceae (Dinophyceae). *British Phycological Journal* 28:39–45.
- Trench, R. K., & Blank, R. J. 1987. *Symbiodinium microadriaticum* Freudenthal, *S. goreauii* sp. nov., *S. kawagutii* sp. nov. and *S. pilosum* sp. nov.: gymnodinioid dinoflagellate symbionts of marine invertebrates. *Journal of Phycology* 23: 469–481.
- Von Stosch, H. A. 1964. Zum problem der sexuellen fortlanzung in der Peridineengattung *Ceratium*. *Helgoländer Meeresuntersuchungen* 10:140–152.
- Von Stosch, H. A. 1969a. Dinoflagellaten aus der Nordsee I. über *Cachonina niei* Loeblich (1968), *Gonyaulax grindleyi* Reinecke (1967) und ein methode zur darstellung von Peridinnenpanzern. *Helgoländer Meeresuntersuchungen* 19:558–568.
- Von Stosch, H. A. 1969b. Dinoflagellaten aus der Nordsee II. *Helgolandinium subglobosum* gen. et spec. nov. *Helgoländer Meeresuntersuchungen* 19:569–577.
- Wall, D., & Dale, B. 1968. Modern dinoflagellate cysts and evolution of the Peridinales. *Micropaleontology* 14:265–304.
- Wall, D., & Dale, B. 1969. The "hystrichosphaerid" resting spore of the dinoflagellate *Pyrodinium bahamense* Plate, 1906. *Journal of Phycology*. 5:140–149.
- Wall, D., & Dale, B. 1971. A reconsideration of living and fossil *Pyrophacus* Stein, 1883 (Dinophyceae). *Journal of Phycology* 7:221–235.
- Watanabe, M. M., Inouye, I., Sawaguchi, T., & Chihara, M. 1990. *Lepidodinium viride* gen. et sp. nov. (Gymnodinales, Dinophyta), a green dinoflagellate with a chlorophyll a- and b-containing endosymbiont. *Journal of Phycology* 26:741–751.
- Whedon, W. F., & Kofoid, C. A. 1936. Dinoflagellata of the San Francisco region. I. On the skeletal morphology of two new species, *Gonyaulax catenella* and *G. acatenella*. *University of California Publications in Zoology* 41:25–34.
- Yarranton, G. A. 1967. Parameters for use in distinguishing populations of *Euceratium* Gran. *Bulletin of Marine Ecology* 6:147–158.
- Yuki, K., & Fukuyo, Y. 1992. *Alexandrium satoanum* sp. nov. (Dinophyceae) from Matoya Bay, central Japan. *Journal of Phycology* 28:395–399.
- Yuki, K., & Yoshimatsu, S. 1989. New record of *Alexandrium insuetum* Balech (Dinophyceae) from Japan with some supplementary observations on thecal morphology. *Bulletin of Plankton Society of Japan* 36:121–126.
- Zingmark, R. G. 1970. Sexual reproduction in the dinoflagellate *Noctiluca miliaris* Suriray. *Journal of Phycology* 6:122–126.
- Zingone, A., & Montesor, M. 1988. *Protoperidinium parthenopes* sp. nov. (Dinophyceae), an intriguing dinoflagellate from the Gulf of Naples. *Cryptogamie Algologie* 9:117–125.

# Index

---

- Acanthogonyaulax spinifera*,  
identification, 503–504
- Achnanthes taeniata*, identification, 269
- Actiniscus pentasterias*, identification,  
468, 470
- Actinocyclus*  
distribution, 121, 123  
fasciculation, 118  
generic characters, 117–118
- Actinocyclus actinochilus*, identification,  
119
- Actinocyclus circellus*, identification, 119
- Actinocyclus curvatulus*, identification,  
121–122
- Actinocyclus exiguus*, identification, 122
- Actinocyclus normanii*, identification,  
119–120
- Actinocyclus octonarius*, identification,  
120
- Actinocyclus sagittulus*, identification,  
120
- Actinocyclus spiritus*, identification,  
122–123
- Actinocyclus subtilis*, identification,  
120–121
- Actinocyclus vestigulus*, identification,  
123
- Actinoptychus senarius*, identification,  
141
- Adenoides eludens*, identification, 550
- Adoneis pacifica*, identification, 248
- Alexandrium acatenella*, identification,  
490
- Alexandrium affine*, identification, 490
- Alexandrium andersonii*, identification,  
490
- Alexandrium angustitabulatum*,  
identification, 490, 492
- Alexandrium balechii*, identification, 492
- Alexandrium catenella*, identification,  
492
- Alexandrium cohorticula*, identification,  
492
- Alexandrium compressum*, identification  
492
- Alexandrium concavum*, identification,  
492
- Alexandrium foedum*, identification, 492
- Alexandrium fraterculus*, identification,  
494
- Alexandrium fundyense*, identification,  
494
- Alexandrium hiranoi*, identification, 494
- Alexandrium insuetum*, identification,  
494
- Alexandrium kutnerae*, identification,  
496–497
- Alexandrium leei*, identification, 497
- Alexandrium lusitanicum*, identification,  
497
- Alexandrium margalefi*, identification,  
497
- Alexandrium minutum*, identification,  
488, 490, 497
- Alexandrium monilatum*, identification,  
497, 499
- Alexandrium ostensfeldii*, identification,  
499
- Alexandrium peruvianum*, identification,  
499
- Alexandrium pseudogonyaulax*,  
identification, 499–500

- Alexandrium tamarense*, identification, 500
- Alexandrium tamiyanichi*, identification, 500
- Alexandrium tropicale*, identification, 500
- Amphidiniopsis kofoidii*, identification, 546
- Amphidinium carterae*, identification, 444
- Amphidinium operculatum*, identification, 445
- Amphidinium poecilochroum*, identification, 445
- Amphidoma nucula*, identification, 504
- Amphisolenia bidentata*, identification, 426
- Amphisolenia globifera*, identification, 428
- Amylax triacantha*, identification, 504
- Antapex, 391
- Apex, 392
- Apical groove, 403
- Apical pore complex, 406
- Archeopyle, 411
- Areolate, 406
- Arocellulus*  
distribution, 179  
generic characters, 179  
species, 179
- Asterionellopsis*  
distribution, 243  
generic characters, 241  
identification, 243  
species, 243
- Asterolampra*  
distribution, 133  
identification, 133
- Asterolampraceae  
characterization, 131–132  
genera, 133, 135, 137, 139–140
- Asteromphalus*  
distribution, 135, 140  
identification, 133, 135
- Asteromphalus arachne*, identification, 137
- Asteromphalus elegans*, identification, 137
- Asteromphalus flabellatus*, identification, 135
- Asteromphalus heptactis*, identification, 137
- Asteromphalus hookeri*, identification, 139
- Asteromphalus hyalinus*, identification, 139
- Asteromphalus parvulus*, identification, 139
- Asteromphalus roperianus*, identification, 139–140
- Asteromphalus sarcophagus*, identification, 135
- Attachment pore, 406–407
- Attheya septentrionalis*, identification, 225
- Aulacodiscus argus*, identification, 137
- Auxospore, formation in diatoms, 8–9
- Azpeitia*  
distribution, 126  
generic characters, 123–124
- Azpeitia africana*, identification, 124
- Azpeitia barronii*, identification, 124
- Azpeitia neocrenulata*, identification, 124, 126
- Azpeitia nodulifera*, identification, 126
- Azpeitia tabularis*, identification, 126, 128
- Bacillariaceae  
generic characters, 291, 293  
terminology, 290–291
- Bacillaria paxillifera*, identification, 293
- Bacteriastrum*  
distribution, 189  
generic characters, 186, 188  
identification, 189  
species, 188–189
- Bacterosira bathyomphala*  
distribution, 33  
identification, 31, 33
- Balechina coerulea*, identification, 461–462

- Banquisia belgicae*, identification, 286
- Bellerochea*  
 distribution, 229  
 generic characters, 227  
 identification, 229–230  
 species, 229
- Blatodinales, identification, 549
- Bleakeleya notata*, identification, 244
- Blepharocysta splendor-maris*,  
 identification, 533
- Boreadinium pisiforme*, identification,  
 527
- Brachydidinium capitatum*, identification,  
 468
- Brockmanniella brockmannii*,  
 identification, 179, 181
- Centrodinium elongatum*, identification,  
 516
- Cerataulina*  
 characteristics, 169, 171  
 distribution, 171  
 identification, 171
- Ceratium arcticum*, identification, 471
- Ceratium arietinum*, identification, 471
- Ceratium candelabrum*, identification,  
 471
- Ceratium carriense*, identification, 471
- Ceratium contortum*, identification, 472
- Ceratium declinatum*, identification, 472
- Ceratium furca*, identification, 472
- Ceratium fusus*, identification, 472
- Ceratium gibberum*, identification, 472,  
 474
- Ceratium gravidum*, identification, 474
- Ceratium hexacanthum*, identification,  
 474
- Ceratium horridum*, identification, 474
- Ceratium incisum*, identification, 474
- Ceratium inflatum*, identification, 474
- Ceratium kofoidii*, identification, 475
- Ceratium limulus*, identification, 475
- Ceratium lineatum*, identification, 475
- Ceratium longipes*, identification, 475
- Ceratium lunula*, identification, 475
- Ceratium macroceros*, identification,  
 475, 477
- Ceratium massiliense*, identification, 477
- Ceratium pentagonum*, identification,  
 477
- Ceratium platycorne*, identification, 477
- Ceratium pleuroceras*, identification,  
 470–471
- Ceratium praelongum*, identification,  
 477
- Ceratium pulchellum*, identification, 478
- Ceratium ranipes*, identification, 478
- Ceratium symmetricum*, identification,  
 478
- Ceratium teres*, identification, 478
- Ceratium trichoceros*, identification, 478
- Ceratium tripos*, identification, 478
- Ceratium vultur*, identification, 482
- Ceratocorys armata*, identification, 482
- Ceratocorys horrida*, identification, 482
- Chaetoceros*  
 distribution, 196, 198, 203, 207,  
 210–211, 215, 220, 224  
 generic characters, 189–191  
 subgeneric characters, 191–193
- Chaetoceros aequatorialis*, identification,  
 193
- Chaetoceros affinis*, identification, 216,  
 218
- Chaetoceros anastomosans*,  
 identification, 210
- Chaetoceros atlanticus*, identification,  
 196
- Chaetoceros borealis*, identification,  
 198–199
- Chaetoceros castracanei*, identification,  
 199
- Chaetoceros ceratosporus*, identification,  
 221, 223
- Chaetoceros cinctus*, identification, 211,  
 213
- Chaetoceros coarctatus*, identification,  
 199
- Chaetoceros compressus*, identification,  
 206
- Chaetoceros concavicornis*,  
 identification, 199



- Chaetoceros constrictus*, identification, 209
- Chaetoceros convolutus*, identification, 199, 201
- Chaetoceros costatus*, identification, 218–219
- Chaetoceros criophilus*, identification, 193, 195
- Chaetoceros curvisetus*, identification, 211
- Chaetoceros dadayi*, identification, 201
- Chaetoceros danicus*, identification, 195
- Chaetoceros debilis*, identification, 211
- Chaetoceros decipiens*, identification, 204
- Chaetoceros densus*, identification, 201
- Chaetoceros diadema*, identification, 220
- Chaetoceros dictyota*, identification, 196
- Chaetoceros didymus*, identification, 207, 209
- Chaetoceros diversus*, identification, 216
- Chaetoceros eibonii*, identification, 201
- Chaetoceros flexuosus*, identification, 203–204
- Chaetoceros furcellatus*, identification, 213
- Chaetoceros holsaticus*, identification, 220
- Chaetoceros karianus*, identification, 219
- Chaetoceros lacinosus*, identification, 209–210
- Chaetoceros lauderi*, identification, 207
- Chaetoceros lorenzianus*, identification, 204
- Chaetoceros messanensis*, identification, 216
- Chaetoceros minimus*, identification, 224
- Chaetoceros mitra*, identification, 204, 206
- Chaetoceros neglectus*, identification, 207
- Chaetoceros peruvianus*, identification, 195
- Chaetoceros pseudocurvisetus*, identification, 211
- Chaetoceros radicans*, identification, 213
- Chaetoceros rostratus*, identification, 196
- Chaetoceros seiracanthus*, identification, 220
- Chaetoceros similis*, identification, 210
- Chaetoceros simplex*, identification, 223
- Chaetoceros socialis*, identification, 221
- Chaetoceros subtilis*, identification, 219
- Chaetoceros tenuissimus*, identification, 223
- Chaetoceros teres*, identification, 206–207
- Chaetoceros tetrastichon*, identification, 203
- Chaetoceros thronsenii*, identification, 224
- Chaetoceros tortissimus*, identification, 213
- Chaetoceros wighamii*, identification, 219
- Chaetocerotaceae  
characteristics, 186  
genera, 184–186
- Chloroplast, diatom characteristics, 7
- Cingulum, 392, 403–405
- Citharistes regius*, identification, 428
- Cladopyxis brachiolata*, identification, 482, 487
- Climacodium*  
characteristics, 172  
distribution, 172  
identification, 172
- Cochlodinium citron*, identification, 445
- Cochlodinium polykrikoides*, identification, 446
- Coolia monotis*, identification, 513, 515
- Corethron*  
distribution, 97  
identification, 96–97
- Corythodinium constrictum*, identification, 517
- Corythodinium tessellatum*, identification, 516–517
- Coscinodiscus*  
characteristics, 97–98  
distribution, 110

- frustules, 102–103
- processes, 101
- Coscinodiscus alboranii*, identification, 106–107
- Coscinodiscus argus*, identification, 103–104
- Coscinodiscus asteromphalus*, identification, 104
- Coscinodiscus bouvet*, identification, 109
- Coscinodiscus centralis*, identification, 105
- Coscinodiscus concinniformis*, identification, 106
- Coscinodiscus concinnus*, identification, 105
- Coscinodiscus granii*, identification, 109–110
- Coscinodiscus jonesianus*, identification, 107
- Coscinodiscus marginatus*, identification, 107
- Coscinodiscus radiatus*, identification, 107, 109
- Coscinodiscus wailesii*, identification, 106
- Crypthecodinium cohnii*, identification, 488
- Crypthecodinium setense*, identification, 487–488
- Cyclotella*
  - distribution, 33–34
  - identification, 33–34
- Cylindrotheca closterium*, identification, 294
- Cymatosira*
  - distribution, 182
  - identification, 181–182
- Cymatosiraceae
  - characteristics, 177–178
  - genera, 178
- Cymbodinium elegans*, identification, 466
- Dactyliosolen*
  - characteristics, 165–166
  - distribution, 168
  - species, 166
- Dactyliosolen antarcticus*, identification, 166–167
- Dactyliosolen blavyanus*, identification, 167
- Dactyliosolen fragilissimus*, identification, 167
- Dactyliosolen phuketensis*, identification, 167–168
- Dactyliosolen tenuijunctus*, identification, 167
- Delphineis*
  - distribution, 249
  - species characters, 248–249
- Denticulate, 407
- Detonula*
  - distribution, 36
  - identification, 35–36
- Diatom
  - cell wall fine structure, 17
  - centric diatoms, classification, 23, 25–26, 28–31
  - classification systems, 5, 23
  - collection and concentration, 331–333
  - colony types, 20
  - electron microscopy, 335–337
  - general characteristics, 6–7
  - gross morphology, 14, 17
  - handbooks, 6
  - identification, *see individual species*
  - index of taxa, 351–361
  - light microscopy, 27, 334–337
  - pennate diatoms
    - classification, 26–27
    - terminology, 240–241, 267, 269
  - preservation and storage, 333–334
  - processes, 17, 20
  - relatives, 6
  - reproduction, 7–10
  - resting spore formation, 11, 13
  - size, 7–8
  - species number, 6
  - synonyms, 341–350
  - unialgal culture, 333
  - valve heteromorphy, 10
- Dinamoebiales, identification, 550

- Dinoflagellate  
 chromosome number, 388  
 evolution, 387, 389  
 fixation for microscopy, 551–552  
 identification, *see individual species*  
 index of taxa, 565–570  
 Kofoidian plate formulae, 412–414  
 life cycle, 411, 415–416  
 microanatomy, 401–402  
 microscopic techniques, 553–554  
 morphology  
   terminology, 391–392, 400–411  
   types, 391  
 nucleus, 388, 390  
 nutritional modes, 388–390  
 pigmentation, 387, 390  
 reproduction, 390  
 slide mounting, 552–553  
 synonyms, 554–565  
 theca, 387–388, 390
- Dinophysis acuminata*, identification, 429
- Dinophysis acuta*, identification, 429
- Dinophysis caudata*, identification, 431
- Dinophysis dens*, identification, 431
- Dinophysis diegensis*, identification, 431
- Dinophysis fortii*, identification, 431
- Dinophysis hastata*, identification, 433
- Dinophysis norvegica*, identification, 433
- Dinophysis odiosa*, identification, 433
- Dinophysis schuettii*, identification, 433–434
- Dinophysis tripos*, identification, 434
- Dinophysis uracantha*, identification, 434
- Diplopelta parva*, identification, 529
- Diplopsalopsis orbicularis*, identification, 529
- Ditylum*  
 distribution, 231  
 generic characters, 230–231  
 identification, 231  
 species, 231
- Ecdysis, 411
- Electron microscopy  
 diatom  
   identification, 338–339  
   preparation, 335–336  
   scanning electron microscopy, 337  
   transmission electron microscopy, 337  
 dinoflagellates, 553–554
- EM, *see* Electron microscopy
- Encystment, 411, 415
- Enciculifera carinata*, identification, 524
- Enciculifera mexicana*, identification, 523–524
- Ephemera planamembranacea*, identification, 284
- Epitheca, 392
- Erythrospidium agile*, identification, 459
- Ethmodiscus*  
 distribution, 111  
 identification, 110–111
- Eucampia*  
 characteristics, 172, 175  
 distribution, 176  
 identification, 176  
 species, 175–176
- Flagella, diatom characteristics, 7
- Fragilaria striatula*, identification, 246
- Fragilariineae, family characters, 241
- Fragilariopsis*  
 distribution, 305  
 generic characters, 295–297  
 identification, 295
- Fragilariopsis atlantica*, identification, 299
- Fragilariopsis curta*, identification, 303
- Fragilariopsis cylindriiformis*, identification, 302–303
- Fragilariopsis cylindrus*, identification, 302
- Fragilariopsis doliolus*, identification, 303, 305
- Fragilariopsis oceanica*, identification, 299–300

- Fragilariopsis pseudonana*, identification, 300
- Fragilariopsis rhombica*, identification, 300
- Fragilariopsis ritscheri*, identification, 297, 299
- Fragilariopsis separanda*, identification, 302
- Fragilidium fissile*, identification, 521
- Fragilidium heterolobum*, identification, 520–521
- Fragilidium mexicanum*, identification, 521, 523
- Gambierdiscus toxicus*, identification, 501
- Goniodoma polyedricum*, identification, 501
- Goniodoma sphaericum*, identification, 503
- Gonyaulax alaskensis*, identification, 506
- Gonyaulax fragilis*, identification, 506
- Gonyaulax grindleyi*, identification, 506–507
- Gonyaulax polygramma*, identification, 507
- Gonyaulax scrippsae*, identification, 507
- Gonyaulax spinifera*, identification, 507, 509
- Gonyaulax verior*, identification, 509
- Gossleriella tropica*  
distribution, 116  
identification, 115
- Gotoius abei*, identification, 529
- Guinardia*  
characteristics, 160  
distribution, 165  
species, 161
- Guinardia cylindrus*, identification, 161
- Guinardia delicatula*, identification, 161
- Guinardia flaccida*, identification, 163
- Guinardia striata*, identification, 163
- Guinardia tubiformis*, identification, 165
- Gymnodinium abbreviatum*, identification, 446
- Gymnodinium breve*, identification, 447
- Gymnodinium catenatum*, identification, 447
- Gymnodinium galatheanum*, identification, 447, 449
- Gymnodinium heterostriatum*, identification, 449
- Gymnodinium mikimotoi*, identification, 449
- Gymnodinium pulchellum*, identification, 449
- Gymnodinium sanguineum*, identification, 451
- Gyrodinium aureolum*, identification, 452
- Gyrodinium estuariale*, identification, 452
- Gyrodinium fissum*, identification, 452
- Gyrodinium instriatum*, identification, 452–453
- Gyrodinium lachryma*, identification, 453
- Gyrodinium pingue*, identification, 453
- Gyrodinium spirale*, identification, 453
- Gyrodinium uncatenum*, identification, 453
- Haslea*  
distribution, 278  
generic characters, 276
- Haslea gigantea*, identification, 276–277
- Haslea trompii*, identification, 278
- Haslea wawrikan*, identification, 278
- Helicotheca tamesis*, identification, 234–235
- Hemiaulaceae  
characteristics, 168–169  
genera, 169
- Hemiaulus*  
characteristics, 176–177  
distribution, 177  
identification, 177  
species, 177
- Hemidiscaceae, identification, 116–117, 339

- Hemidiscus*  
 distribution, 130  
 generic characters, 128  
 identification, 128, 130
- Herdmania littoralis*, identification, 462–463
- Heterocapsa niei*, identification, 531
- Heterocapsa triquetra*, identification, 530–531
- Heterodinium milneri*, identification, 513
- Heterodinium rigdenae*, identification, 513
- Histioneis depressa*, identification, 434
- Horn, 407
- Hyalochaetae*, subgeneric characters, 192–193
- Hypotheca, 400
- Katodinium fungiforme*, identification, 455
- Katodinium glaucum*, identification, 455
- Katodinium rotundatum*, identification, 456
- Kofoidinium velleloides*, identification, 463–464
- Lauderia annulata*  
 distribution, 37  
 identification, 36–37
- Lennoxia faveolata*, identification, 184
- Lepidodinium viride*, identification, 456
- Leptocylindrus*  
 distribution, 95  
 identification, 93, 95–96
- Leptodiscus medusoides*, identification, 466
- Light microscopy  
 diatom  
 identification, 27, 336–338  
 preparation, 334–335  
 dinoflagellates, 553–554
- Lingulodinium polyedra*, identification, 509–510
- Lioloma*  
 distribution, 257  
 generic characters, 254  
 species, 254, 257  
 taxonomy, 338
- Lissodinium schilleri*, identification, 533
- Lithodesmiaceae  
 classification, 225–226  
 family characters, 226  
 genera, 227
- Lithodesmioides*  
 distribution, 232  
 generic characters, 232  
 identification, 232  
 species, 232
- Lithodesmium*  
 distribution, 234  
 generic characters, 233  
 identification, 234  
 species, 233–234
- Manguinea fusiformis*, identification, 289
- Manguinea rigida*, identification, 289
- Melosira*  
 distribution, 89  
 identification, 89
- Melosiraceae, classification, 88–89
- Membraneis challengeri*, identification, 287
- Membraneis imposter*, identification, 287
- Mesoporos*, identification, 418–419
- Metacytic growth zone, 402
- Meuniera membranacea*, identification, 273, 339
- Microscopy, *see* Electron microscopy;  
 Light microscopy
- Minidiscus*  
 distribution, 37, 39  
 identification, 37, 39
- Minutocellus*  
 distribution, 183  
 generic characters, 182  
 species, 183
- Mitochondria, diatom characteristics, 7

- Nanoneis hasleae*, identification, 271
- Navicula*  
 classification, 271–273, 278, 280  
 identification, 275  
 species, 275
- Navicula directa*, identification, 280
- Navicula distans*, identification, 280
- Navicula transitans*, identification,  
 280–281
- Naviculaceae  
 characters, 272  
 classification, 271–272
- Nematocyst, 401
- Nematodinium armatum*, identification,  
 459–460
- Neodelphineis*  
 distribution, 251  
 generic characters, 249  
 species, 251
- Neodenticula seminae*, identification,  
 306
- Neostreptotheca*  
 distribution, 236  
 generic characters, 235–236  
 species, 236
- Nitzschia americana*, identification, 324
- Nitzschia bicapitata*, identification, 330
- Nitzschia braarudii*, identification,  
 330–331, 339
- Nitzschia kolaczekii*, identification,  
 328–329
- Nitzschia longissima*, identification,  
 329–330
- Nitzschia marina*, identification, 328
- Nitzschia sicula*, identification, 327–328
- Noctiluca scintillans*, identification, 466
- Oblea baculifera*, identification,  
 529–530
- Ocellus, 401
- Odontella*  
 distribution, 239  
 generic characters, 236, 238–239  
 identification, 239  
 species, 239
- Ornithocercus heteroporus*,  
 identification, 436
- Ornithocercus magnificus*, identification,  
 436
- Ornithocercus quadratus*, identification,  
 436
- Ornithocercus splendidus*, identification,  
 437
- Ornithocercus steinii*, identification, 437
- Ornithocercus thumii*, identification, 437
- Ostreopsis heptagona*, identification,  
 515
- Ostreopsis lenticularis*, identification,  
 515
- Ostreopsis ovata*, identification,  
 515–516
- Ostreopsis siamensis*, identification, 516
- Oxyphysis oxytoides*, identification, 442,  
 444
- Oxyrrhis marina*, identification, 551
- Oxytoxum scolopax*, identification, 517,  
 519
- Oxytoxum variabile*, identification, 519
- Pachyneis gerlachii*, identification, 290
- Paleophalacroma uncinatum*,  
 identification, 487
- Palmeria*  
 distribution, 112  
 identification, 111–112
- Paralia*  
 distribution, 91  
 identification, 89, 91
- Peduncle, 400
- Pellicle, 400
- Pentapharsodinium dalei*, identification,  
 524–525
- Peridiniella catenata*, identification, 510
- Peridinium cinctum*, identification, 531
- Periflagellar plate, 402
- Phaeoceros*, subgeneric characters,  
 191–192
- Phaeodactylum tricornutum*,  
 identification, 269–271
- Phalacroma argus*, identification, 437,  
 439

- Phalacroma cuneus*, identification, 439  
*Phalacroma doryphorum*, identification, 439  
*Phalacroma favus*, identification, 439  
*Phalacroma mitra*, identification, 439  
*Phalacroma rapa*, identification, 439  
*Phalacroma rotundatum*, identification, 439, 441–442  
*Pheopolykrikos hartmannii*, identification, 457  
Phytodinales, identification, 549  
Phytoplankton Manual of Methodology, development, 1–4  
Pigment, diatom characteristics, 7  
*Plagiogrammopsis vanheurckii*, identification, 183  
*Plagiotropis gaussii*, identification, 289  
*Planktoniella*  
distribution, 40  
identification, 39–41  
*Pleromonas erosa*, identification, 551  
*Pleurosigma*  
distribution, 283  
generic characters, 281–282  
*Pleurosigma directum*, identification, 282  
*Pleurosigma normanii*, identification, 282  
*Pleurosigma simonsenii*, identification, 282–283  
*Podolampas bipes*, identification, 534  
*Podolampas elegans*, identification, 534  
*Podolampas palmipes*, identification, 534  
*Polykrikos kofoidii*, identification, 457, 459  
*Pomatodinium impatiens*, identification, 464  
*Porosira*  
distribution, 43  
identification, 41, 43  
*Preperidinium meunieri*, identification, 530  
*Pronoclituca acuta*, identification, 467  
*Prorocentrum*  
distribution, 420  
identification, 419–420  
*Prorocentrum arcuatum*, identification, 420  
*Prorocentrum balticum*, identification, 420  
*Prorocentrum belizeanum*, identification, 420  
*Prorocentrum compressum*, identification, 420, 423  
*Prorocentrum concavum*, identification, 423  
*Prorocentrum dentatum*, identification, 423  
*Prorocentrum emarginatum*, identification, 423  
*Prorocentrum gracile*, identification, 423–424  
*Prorocentrum lima*, identification, 424  
*Prorocentrum mexicanum*, identification, 424  
*Prorocentrum micans*, identification, 424–425  
*Prorocentrum minimum*, identification, 425  
*Prorocentrum rostratum*, identification, 425  
*Prorocentrum sabulosum*, identification, 425  
*Prorocentrum scutellum*, identification, 425  
*Prorocentrum triestinum*, identification, 426  
*Protoceratium spinulosum*, identification, 510, 512  
*Proto-peridinium brevipes*, identification, 536  
*Proto-peridinium claudicans*, identification, 536  
*Proto-peridinium conicoides*, identification, 538  
*Proto-peridinium conicum*, identification, 538  
*Proto-peridinium crassipes*, identification, 538  
*Proto-peridinium depressum*, identification, 538  
*Proto-peridinium divergens*, identification, 538, 540

- Proto-peridinium elegans*, identification, 540
- Proto-peridinium excentricum*, identification, 540
- Proto-peridinium fatulipes*, identification, 540
- Proto-peridinium grande*, identification, 540
- Proto-peridinium leonis*, identification, 541
- Proto-peridinium minutum*, identification, 541
- Proto-peridinium nudum*, identification, 541
- Proto-peridinium oblongum*, identification, 541–542
- Proto-peridinium obtusum*, identification, 542
- Proto-peridinium oceanicum*, identification, 542
- Proto-peridinium pallidum*, identification, 542
- Proto-peridinium parthenopes*, identification, 542
- Proto-peridinium pellucidum*, identification, 536
- Proto-peridinium pellucidum*, identification, 542, 545
- Proto-peridinium pentagonum*, identification, 545
- Proto-peridinium quarnerense*, identification, 545
- Proto-peridinium subinermis*, identification, 545–546
- Proto-peridinium thorianum*, identification, 546
- Pseudo-nitzschia*  
classification, 307  
distribution, 307, 316, 323  
generic characters, 308  
identification, 316–317, 323–324  
species, 308–310
- Pseudo-nitzschia australis*, identification, 311–312
- Pseudo-nitzschia cuspidata*, identification, 319, 321
- Pseudo-nitzschia delicatissima*, identification, 317
- Pseudo-nitzschia fraudulenta*, identification, 313, 315
- Pseudo-nitzschia granii*, identification, 321
- Pseudo-nitzschia heimii*, identification, 315
- Pseudo-nitzschia lineola*, identification, 317
- Pseudo-nitzschia multiseries*, identification, 312–313
- Pseudo-nitzschia prolongatoides*, identification, 317, 319
- Pseudo-nitzschia pseudodelicatissima*, identification, 321
- Pseudo-nitzschia pungens*, identification, 312
- Pseudo-nitzschia pungiformis*, identification, 313
- Pseudo-nitzschia seriata*, identification, 310–311
- Pseudo-nitzschia subcurvata*, identification, 323
- Pseudo-nitzschia subpacifica*, identification, 315
- Pseudo-nitzschia turgidula*, identification, 319
- Pseudoguinaridia recta*  
distribution, 131  
identification, 130–131
- Pseudosolenia calcar avis*, identification, 160
- Ptychodiscus noctiluca*, identification, 463
- Pusule, 401
- Pyrocystis lunula*, identification, 520
- Pyrocystis noctiluca*, identification, 519–520
- Pyrodinium bahamense*, identification, 503
- Pyrophacus horologium*, identification, 523
- Pyrophacus steinii*, identification, 523



- Resting spore  
 formation in diatoms, 11, 13  
 types, 11  
 valves, 13
- Reticulae, 408
- Rhaphoneidaceae  
 family characters, 247  
 genera, 247
- Rhaphoneis amphiceros*, identification, 252
- Rhizosolenia*  
 characteristics, 144, 146  
 distribution, 150, 155–157
- Rhizosolenia acicularis*, identification, 147
- Rhizosolenia acuminata*, identification, 153
- Rhizosolenia alata*, identification, 159
- Rhizosolenia antennata*, identification, 147, 149
- Rhizosolenia bergonii*, identification, 155
- Rhizosolenia borealis*, identification, 147
- Rhizosoleniaceae  
 characteristics, 142  
 genera, 142, 144  
 identification, 141–142
- Rhizosolenia clevei*, identification, 151
- Rhizosolenia crassa*, identification, 150
- Rhizosolenia crastracanei*, identification, 151
- Rhizosolenia curvata*, identification, 147
- Rhizosolenia debyana*, identification, 151
- Rhizosolenia decipiens*, identification, 156–157
- Rhizosolenia fallax*, identification, 156
- Rhizosolenia formosa*, identification, 146–147
- Rhizosolenia hebetata*, identification, 149–150
- Rhizosolenia hyalina*, identification, 151
- Rhizosolenia imbricata*, identification, 155
- Rhizosolenia ostenfeldii*, identification, 155–156
- Rhizosolenia polydactyla*, identification, 150
- Rhizosolenia pungens*, identification, 157
- Rhizosolenia robusta*, identification, 159
- Rhizosolenia setigera*, identification, 157
- Rhizosolenia sima*, identification, 150
- Rhizosolenia simplex*, identification, 155
- Rhizosolenia striata*, identification, 156
- Rhizosolenia styliiformis*, identification, 146
- Rhizosolenia temperi*, identification, 151
- Rib, 408
- Roscoffia capitata*, identification, 546–547
- Schuttiella mitra*, identification, 512
- Scrippsiella precaria*, identification, 526
- Scrippsiella subsalsa*, identification, 526–527
- Scrippsiella sweeneyae*, identification, 525–526
- Scrippsiella trochoidea*, identification, 527
- Sinophysis microcephala*, identification, 442
- Skeletonema*  
 distribution, 45  
 identification, 43–45
- Spatulodinium pseudonocutiluca*, identification, 464
- Spine, 409
- Spiniferodinium galeiforme*, identification, 549–550
- Spiraulax kofoidii*, identification, 512
- Spore, *see* Resting spore
- Stellarima*  
 distribution, 115  
 identification, 113
- Stephanopyxis*  
 distribution, 93  
 identification, 91–93
- Striae  
 Biddulphiales, 29  
 dinoflagellates, 409

- Striatella unipunctata*, identification, 244  
 Sulcus, 401  
 Suture, 409–410  
*Symbiodinium microadriaticum*,  
 identification, 460–461  
 Syndiniales, identification, 549  
*Synedropsis hyperborea*, identification,  
 246–247
- Tabulation, 410  
*Thalassionema*  
 distribution, 262  
 generic characters, 257, 261  
 identification, 262–263  
 species, 261–262  
 Thalassionemataceae  
 family characters, 253  
 genera, 253–254  
*Thalassiosira*  
 distribution, 59, 65, 71, 75, 80, 86  
 identification, 45–46, 48, 50  
 light microscopy, 46–48  
 processes, 48, 50–51  
*Thalassiosira alleni*, identification, 51  
*Thalassiosira angulata*, identification, 51  
*Thalassiosira anguste-lineata*,  
 identification, 71, 73  
*Thalassiosira antarctica*, identification,  
 66, 68  
*Thalassiosira australis*, identification, 73  
*Thalassiosira baltica*, identification,  
 68–69  
*Thalassiosira bioculata*, identification,  
 80, 82  
*Thalassiosira bulbosa*, identification, 53  
 Thalassiosiraceae  
 classification, 29–30  
 processes, 30  
*Thalassiosira conferta*, identification, 54  
*Thalassiosira curviseriata*,  
 identification, 63  
*Thalassiosira delicatula*, identification,  
 59, 61  
*Thalassiosira dichotomica*,  
 identification, 63  
*Thalassiosira diporocyclus*,  
 identification, 61–62  
*Thalassiosira eccentrica*,  
 identification, 62  
*Thalassiosira endoseriata*, identification,  
 87–88  
*Thalassiosira gracilis*, identification,  
 82–83  
*Thalassiosira gravida*, identification, 69  
*Thalassiosira guillardii*,  
 identification, 77  
*Thalassiosira hendeyi*, identification, 62  
*Thalassiosira hyalina*, identification,  
 69–70  
*Thalassiosira hyperborea*,  
 identification, 74  
*Thalassiosira lentiginosa*,  
 identification, 79  
*Thalassiosira leptopus*, identification,  
 75, 77  
*Thalassiosira lineata*, identification, 80  
*Thalassiosira mala*, identification, 54  
*Thalassiosira mediterranea*,  
 identification, 74–75  
*Thalassiosira minima*, identification, 65  
*Thalassiosira miniscula*, identification,  
 54, 56  
*Thalassiosira nordenskiöldii*,  
 identification, 56  
*Thalassiosira oceanica*, identification,  
 56–57  
*Thalassiosira oestrupii*, identification, 83  
*Thalassiosira pacifica*, identification, 57  
*Thalassiosira partheneia*, identification,  
 57–58  
*Thalassiosira perpussilla*, identification,  
 83–84  
*Thalassiosira poroseriata*, identification,  
 86–87  
*Thalassiosira proschkinae*,  
 identification, 84  
*Thalassiosira pseudonana*,  
 identification, 79  
*Thalassiosira ritscheri*, identification, 86  
*Thalassiosira rotula*, identification, 70  
*Thalassiosira simonsenii*,  
 identification, 63

- Thalassiosira subtilis*, identification, 58  
*Thalassiosira tenera*, identification, 59  
*Thalassiosira trifulta*,  
    identification, 87  
*Thalassiosira tumida*, identification,  
    70–71  
*Thalassiosira weissflogii*,  
    identification, 75  
*Thalassiothrix*  
    distribution, 266  
    generic characters, 263, 266  
    identification, 266–267  
    species, 266  
Theca, 387–388, 390  
*Thecadinium kofoidii*, identification,  
    547  
Thecal plate, 401  
Thecal vesicle, 402  
*Thoracosphaera heimii*, identification,  
    547, 549  
*Torodinium teredo*, identification, 456
- Toxarium*  
    distribution, 253  
    generic characters, 252–253  
    identification, 253  
Trichocyst pore, 402  
*Trichotoxon reinboldii*, identification, 267  
*Triposolenia truncata*, identification, 428  
*Tropidoneis*  
    characteristics, 283–284  
    terminology, 283
- Valve, morphology and reproduction, 10  
Ventral pore, 410–411  
Vermiculate, 411
- Warnowia polyphemus*, identification,  
    460  
*Woloszynskia reticulata*, identification,  
    467